

Peak Emission Wavelength: 295nm

The MTSM295UV2-F1120 is a deep ultraviolet light emitting diode with peak emission wavelengths from 290nm to 300nm. The LED is sealed in a ceramic package with UV stable encapsulation. It incorporates state of the art surface mount device (SMD) design and low thermal resistance.

FEATURES

- > Deep ultraviolet LED
- > Low thermal resistance
- > SMT solderable

APPLICATIONS

- > Disinfection
- > Fluorescent spectroscopy
- > Chemical and Biological Analysis

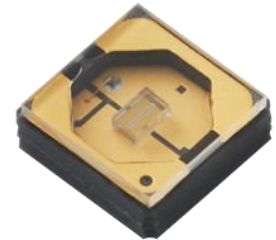

Absolute Maximum Ratings (Ta=25°C)



ITEMS	SYMBOL	RATINGS	UNIT
Forward Current	If	200	mA
Power Dissipation	Pd	1.45	W
Storage Temperature	Tstg	-40 to 100	°C
Operating Temperature	Topr	-30 to 60	°C

Note: Also available on PCB - Star Board MTSM295UV2-F1120S



Electrical & Optical Characteristics (Ta = 25°C)

ITEMS	SYMBOL	CONDITION	VALUE	UNIT
Peak Wavelength [1]	λ_p	IF=150mA	295	nm
Power Output [2]	Po [3]	IF=150mA	10	mW
Forward Voltage [4]	Vf	IF=150mA	6.0	V
FWHM	$\Delta\lambda$	IF=150mA	11	nm
Viewing Angle	$2\theta_{1/2}$	IF=150mA	125	deg
Thermal Resistance	Rth	IF=150mA	31.0	°C/W

Notes:

- [1] Peak wavelength measurement tolerance is ± 3 nm
- [2] Optical Power Output Measurement tolerance is $\pm 10\%$
- [3] θ_e is the Optical Power Output as measured with an integrated sphere.
- [4] Forward voltage measurement tolerance is $\pm 3\%$
- [5] R θ_{j-s} is the thermal resistance between chip junction to solder point.
- [6] The exposure to the absolute maximum rated conditions may affect device reliability
- [7] At extreme temperatures-extra care must be taken to keep devices free from moisture.

Top View

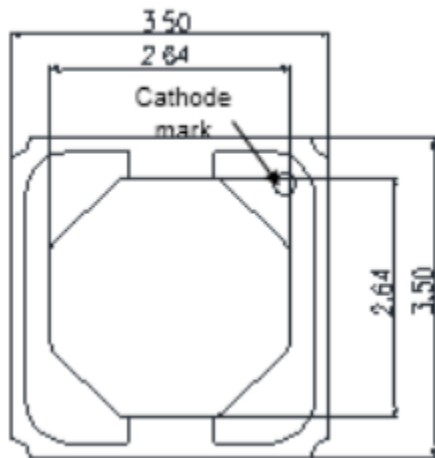

Bottom View

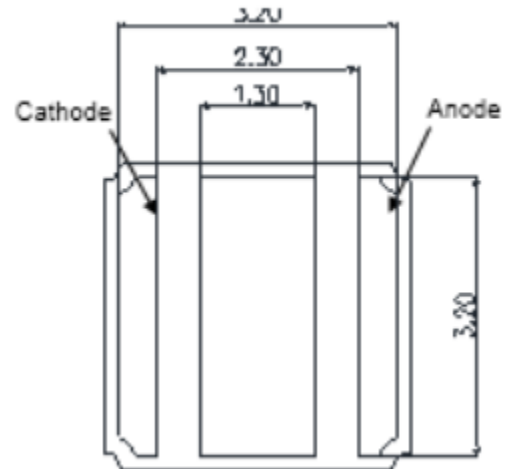

Side View



Circuit

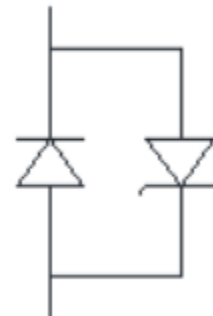

Notes:

- [1] All dimensions in millimeters [inches]
- [2] Drawings not to scale
- [3] All dimensions are for reference only

Fig 1. Spectrum, $T_a=25^\circ\text{C}$, $I_f=150\text{mA}$

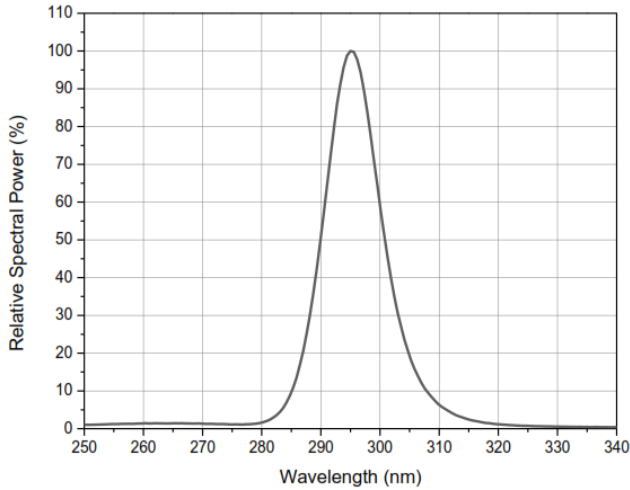

Fig 2. Forward Current vs. Forward Voltage, $T_a=25^\circ\text{C}$

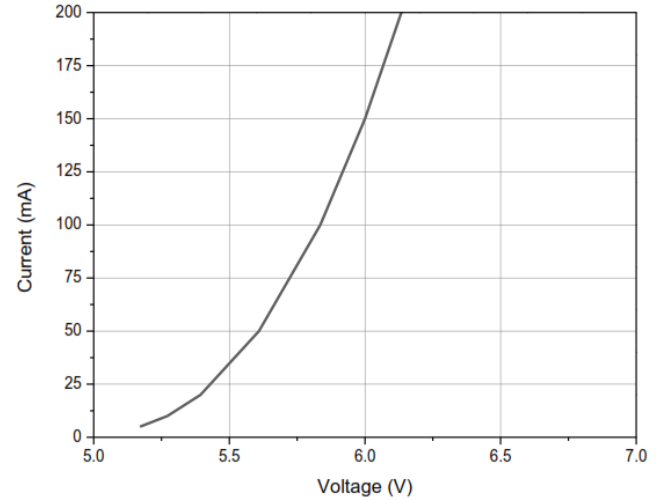

Fig 3. Relative Optical Output Power vs. Forward Current, $T_a=25^\circ\text{C}$

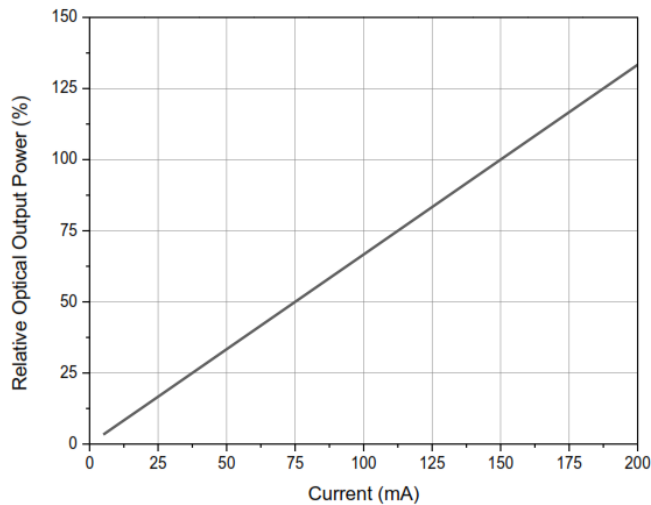

Fig 4. Peak Wavelength vs. Forward Current, $T_a=25^\circ\text{C}$

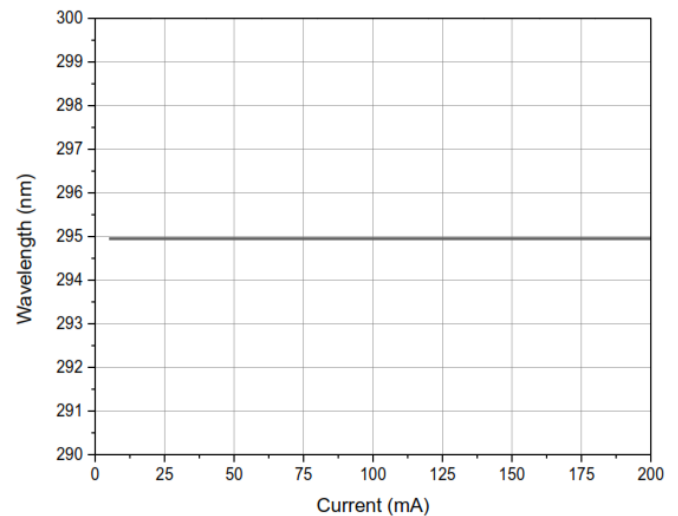

Fig 5. Relative Optical Output Power vs. Solder Point Temperature, $I_F=150\text{mA}$

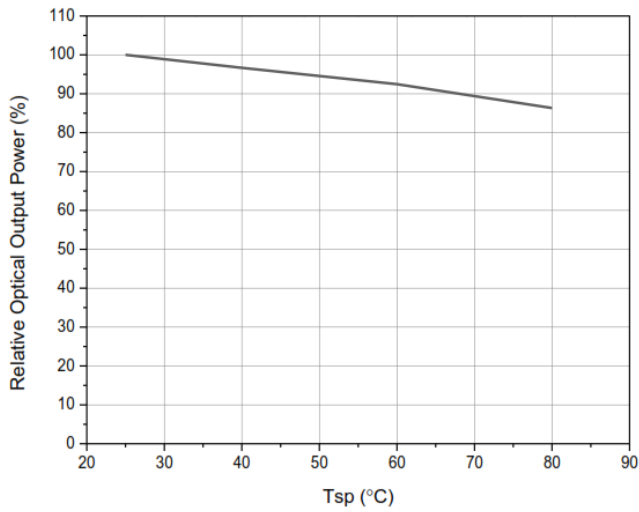

Fig 6. Peak Wavelength vs. Solder Point Temperature $I_F=150\text{mA}$

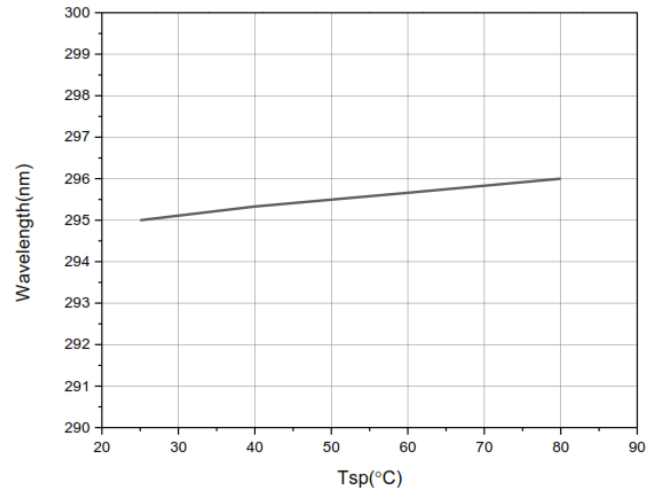

Fig 7. Forward Voltage vs Solder Point Temperature $I_F=150\text{mA}$

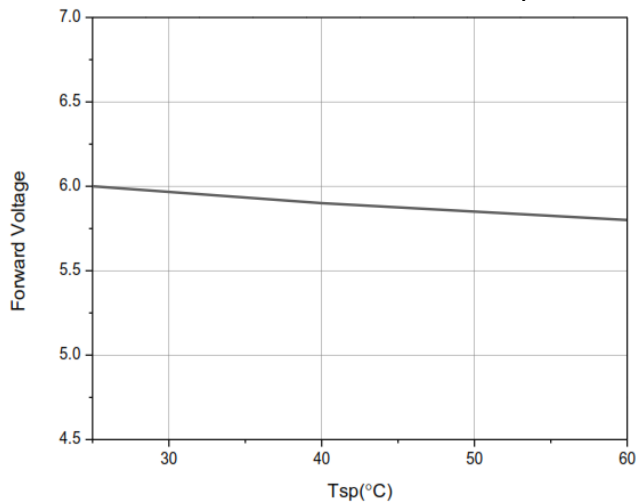
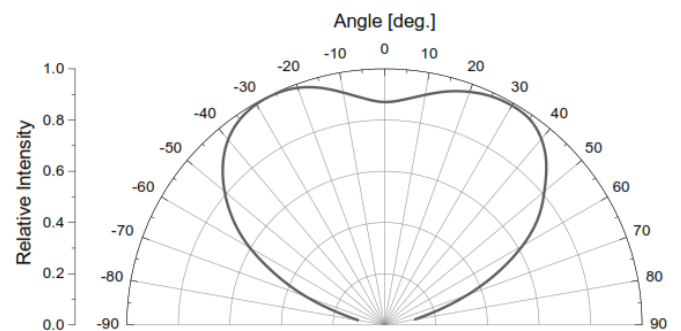
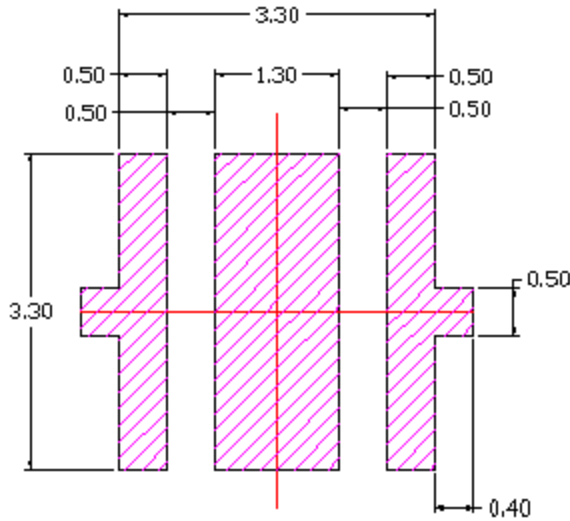

Fig 8. Typical Spatial Distribution, $I_F=150\text{mA}$



Recommended Solder Pad



Recommended PCB Solder Pad

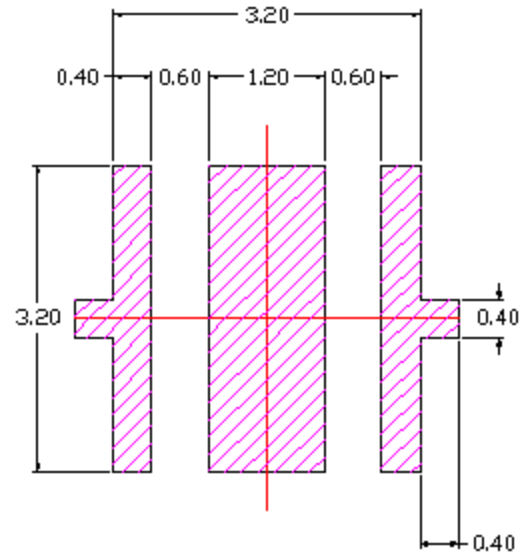

Recommended Stencil Pattern



CAUTION

1. LEDs emit very strong UV radiation during operation.
2. Don't look directly into the LED light when in operation as UV radiation can harm your eyes.
3. To prevent even inadequate exposure, wear protective eyewear.
4. If LEDs are embedded in devices, please indicate warning labels against the UV LED used.
5. Avoid prolonged exposure to skin or other tissue during operation.
6. Keep out of reach of children.
7. Take appropriate precautions around pets and other living organisms to avoid UV exposure.
8. Specification and dimension are subject to change without notice.

Reflow Soldering Characteristics

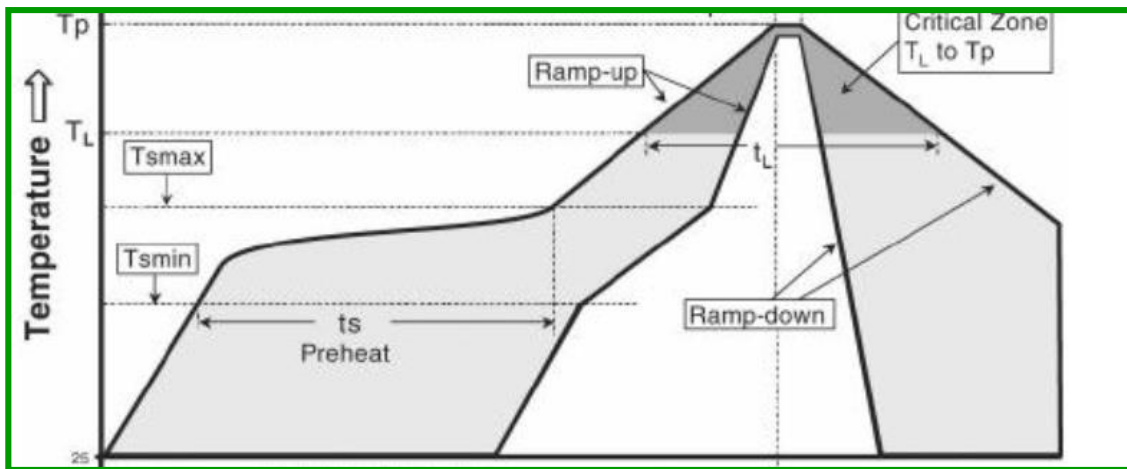

Profile Feature	Sn-Pb Eutectic Assembly	Pb-Free Assembly
Average ramp-up rate (Ts_max to Tp)	3° C/second max.	3° C/second max.
Preheat		
- Temperature Min (Ts_min)	100 °C	150 °C
- Temperature Max (Ts_max)	150 °C	200 °C
- Time (Ts_min to Ts_max) (ts)	60-120 seconds	60-180 seconds
Time maintained above:		
- Temperature (TL)	183 °C	217 °C
- Time (tL)	60-150 seconds	60-150 seconds
Peak Temperature (Tp)	215°C	260°C
Time within 5°C of actual Peak Temperature (t2)	10-30 seconds	20-40 seconds
Ramp-down Rate	6 °C/second max.	6 °C/second max.
Time 25°C to Peak Temperature	6 minutes max.	8 minutes max.

* Caution

1. Reflow soldering should not be done more than one time.
2. Repairs should not be done after the LEDs have been soldered.
When repair is unavoidable, suitable tools must be used.
3. Die slug is to be soldered.
4. When soldering, do not put stress on the LEDs during heating.
5. After soldering, do not warp the circuit board.
6. Recommend to use a convection type reflow machine with 7 ~ 8 zones.

Precaution for Use

UV Light

These devices are ultraviolet LEDs. During operation, the LED emits high intensity ultraviolet (UV) light, which is harmful to skin and eyes.

UV light is hazardous to skin and may cause cancer. Avoid exposure to UV light when LED is operational.

Precautions must be taken to avoid looking directly at the UV light without the use of UV light protective glasses. Do not look directly at the front of the LED or at the LED's lens when LED is operational.

Static Electricity

These products are ESD (electrostatic discharge) sensitive; static electricity and surge voltages seriously damage UV LEDs and can result in complete failure of the device. Precautions must be taken against ESD when handling or operating these devices.

Operating Conditions

In order to ensure the correct functioning of these LEDs, compliance to the maximum electrical specifications is paramount. These LEDs are particularly sensitive to any current value that exceeds the absolute maximum rating of the product. Any applied current in excess of the maximum specification will cause damage and possible complete failure of the product.

The current flowing in a LED is an exponential function of the voltage across it. A small change in voltage can produce a very large change in current and lead to complete failure of the LED. The use of current regulated drive circuits are recommended for these products.

Any attempt to drive these UV LEDs with a voltage source instead of a current source will cause damage and possible complete failure of the product.

These LEDs are susceptible to heat generation. Use care to design end product with adequate thermal management to ensure that LEDs do not exceed maximum recommended temperatures. Operating LEDs at temperatures in excess of specification will result in damage and possible complete failure of the product.

Attach the following warning labels on products/systems that use UV LEDs.

