



May. 2021 Ver.1.3
TDK Corporation

Multilayer Diplexer

For 617-4200MHz / 5150-5925MHz

DPX Series 2.5x2.0mm [EIA 1008] TYPE

P/N: **DPX255925DT-5079B1**

DPX255925DT-5079B1

SHAPES AND DIMENSIONS

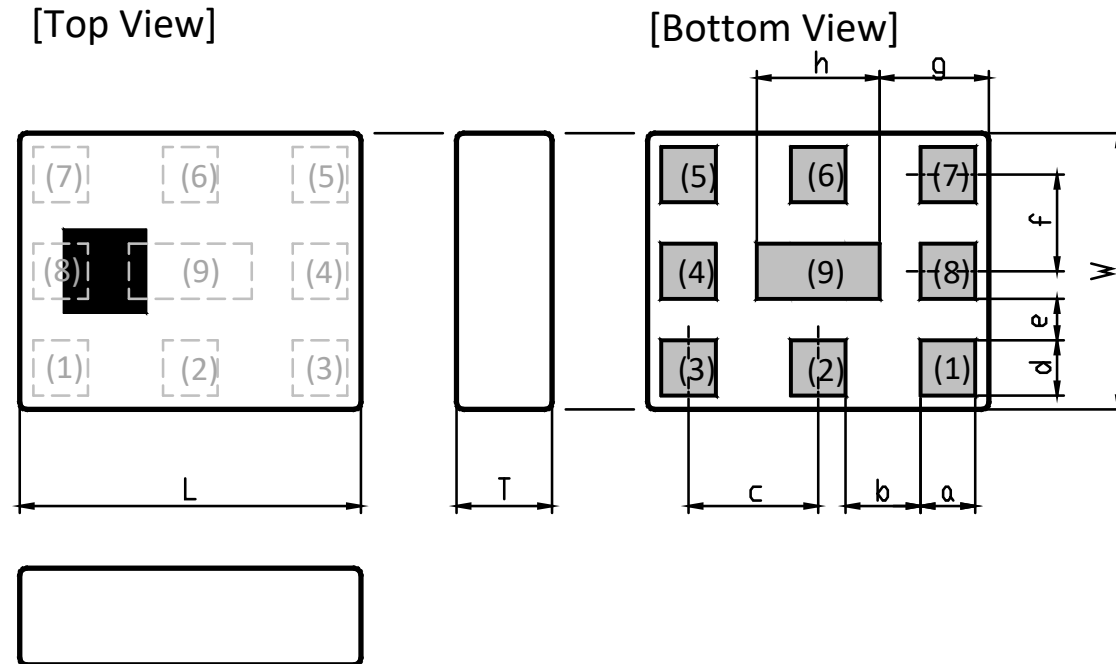

Dimensions (mm)

L	W	T	a	b	c	d	e	f	g	h
2.50	2.00	0.70	0.40	0.55	0.95	0.40	0.30	0.70	0.80	0.90
+/-0.10	+/-0.10	Max	+/-0.10	+/-0.15	+/-0.10	+/-0.10	+/-0.10	+/-0.10	+/-0.10	+/-0.10

Terminal functions

(1)	GND
(2)	Common Port
(3)	GND
(4)	GND
(5)	High-Band Port

(6)	GND
(7)	Low-Band Port
(8)	GND
(9)	GND

TERMINATION FINISH

Material
Au plate

DPX255925DT-5079B1

■ ELECTRICAL CHARACTERISTICS

(Measurement)

Low-Band

Parameter	Frequency (MHz)	TDK Spec		
		Min.	Typ.	Max.
Insertion Loss (dB)	617 to 960	-	0.08	0.30
	1427 to 1661	-	0.13	0.30
	1710 to 2200	-	0.12	0.30
	2300 to 2690	-	0.12	0.45
	3300 to 3800	-	0.26	0.50
	3800 to 4200	-	0.47	0.60
Insertion Loss (dB) (-40 to +85 °C)	617 to 960	-		0.35
	1427 to 1661	-		0.35
	1710 to 2200	-		0.35
	2300 to 2690	-		0.50
	3300 to 3800	-		0.60
	3800 to 4200	-		0.75
VSWR (Low-Band Port)	617 to 960	-	1.18	2.00
	1427 to 1661	-	1.28	2.00
	1710 to 2200	-	1.28	2.00
	2300 to 2690	-	1.24	2.00
	3300 to 3800	-	1.17	2.00
	3800 to 4200	-	1.22	2.00
Attenuation (dB)	5150 to 5925	20	25.7	-
	6600 to 8400	20	23.7	-
	9900 to 12800	20	30.1	-
Characteristic Impedance (ohm)		50 (Nominal)		

Ta = +25+/-5°C

DPX255925DT-5079B1

■ ELECTRICAL CHARACTERISTICS

(Measurement)

High-Band

Parameter	Frequency (MHz)	TDK Spec		
		Min.	Typ.	Max.
Insertion Loss (dB)	5150 to 5250	-	0.70	0.90
	5250 to 5330	-	0.62	0.90
	5490 to 5730	-	0.62	0.90
	5730 to 5925	-	0.68	0.90
Insertion Loss (dB) (-40 to +85 °C)	5150 to 5250	-		1.00
	5250 to 5330	-		1.00
	5490 to 5730	-		1.00
	5730 to 5925	-		1.05
VSWR (High-Band Port)	5150 to 5250	-	1.21	2.00
	5250 to 5330	-	1.14	2.00
	5490 to 5730	-	1.19	2.00
	5730 to 5925	-	1.19	2.00
Attenuation (dB)	700 to 2550	25	27.8	-
	2550 to 2690	35	37.8	-
	3300 to 3800	20	23.8	-
	3800 to 4200	20	23.1	-
	6900 to 7200	10	19.5	-
	7200 to 7800	15	20.9	-
	7800 to 9800	15	23.1	-
	9800 to 11700	18	21.3	-
	14700 to 17850	15	19.0	-
Characteristic Impedance (ohm)		50 (Nominal)		

Ta = +25+/-5°C

DPX255925DT-5079B1**ELECTRICAL CHARACTERISTICS**

(Measurement)

Common

Parameter	Frequency (MHz)	TDK Spec		
		Min.	Typ.	Max.
Isolation (dB)	1427 to 1661	25	27.8	-
	1710 to 2200	25	28.7	-
	2300 to 2690	25	32.8	-
	3300 to 3400	20	28.8	-
	3400 to 3800	20	24.0	-
	3800 to 4200	20	22.9	-
	5150 to 5925	20	27.3	-
VSWR (Common Port)	617 to 960	-	1.18	2.00
	1427 to 1661	-	1.29	2.00
	1710 to 2200	-	1.29	2.00
	2300 to 2690	-	1.25	2.00
	3300 to 3800	-	1.16	2.00
	3800 to 4200	-	1.17	2.00
	5150 to 5250	-	1.25	2.00
	5250 to 5330	-	1.18	2.00
	5490 to 5730	-	1.23	2.00
	5730 to 5925	-	1.25	2.00
Characteristic Impedance (ohm)		50 (Nominal)		

Ta = +25+/-5°C

MAXIMUM RATINGS

Parameter	TDK Spec	Conditions
Operating temperature (°C)	-40 to +85 °C	
Storage temperature (°C)	-40 to +85 °C	
Power Handling (W) *1	Frequency (MHz)	
Low-Band	617 to 960	3 GSM signal Duty 50%
	617 to 4200	2 CW
	to	
High-Band	5150 to 5925	1 CW
Human Body Model : HBM	@Each Port (V)	+/-1000 100pF / 1500ohm
Machine Model : MM	@Each Port (V)	+/-150 200pF / 0ohm
Charged Device Model : CDM	@Each Port (V)	+/-500 Humidity : 60%RH max

*1 : Refer to 3GPP TS 38.101-1 V15.2.0

DPX255925DT-5079B1

FREQUENCY CHARACTERISTICS

Low band-Port

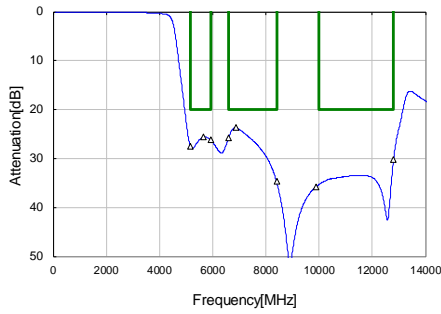

Attenuation

5150 MHz	27.5 dB
5660 MHz	25.7 dB
5925 MHz	26.2 dB
6600 MHz	25.7 dB
6860 MHz	23.7 dB
8400 MHz	34.7 dB
9900 MHz	35.7 dB
12800 MHz	30.1 dB

High band-Port

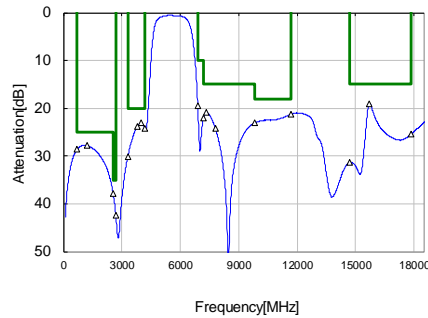

Attenuation

700 MHz	28.6 dB
1200 MHz	27.8 dB
2550 MHz	37.8 dB
2690 MHz	42.4 dB
3300 MHz	30.2 dB
3800 MHz	23.8 dB
4000 MHz	23.1 dB
4200 MHz	24.3 dB
6900 MHz	19.5 dB
7200 MHz	21.9 dB
7360 MHz	20.9 dB
7800 MHz	24.2 dB
9800 MHz	23.1 dB
11700 MHz	21.3 dB
14700 MHz	31.3 dB
15720 MHz	19.0 dB
17850 MHz	25.4 dB

Low band-Port

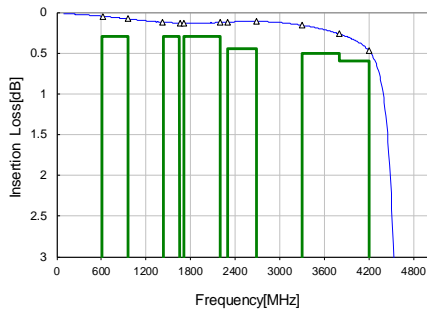

Insertion Loss

617 MHz	0.05 dB
960 MHz	0.08 dB
1427 MHz	0.12 dB
1661 MHz	0.13 dB
1710 MHz	0.13 dB
2200 MHz	0.12 dB
2300 MHz	0.12 dB
2690 MHz	0.11 dB
3300 MHz	0.16 dB
3800 MHz	0.26 dB
4200 MHz	0.47 dB

High band-Port

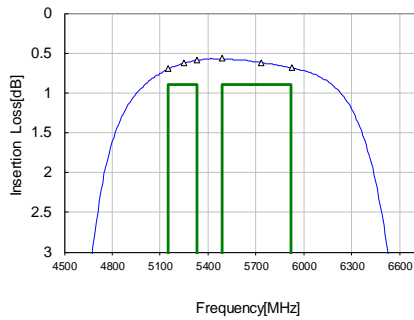

Insertion Loss

5150 MHz	0.70 dB
5250 MHz	0.62 dB
5330 MHz	0.59 dB
5490 MHz	0.57 dB
5730 MHz	0.62 dB
5925 MHz	0.68 dB

Common Port VSWR

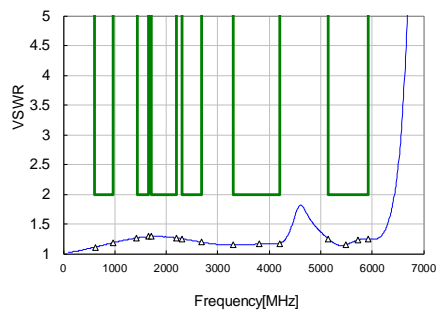

VSWR

617 MHz	1.11
960 MHz	1.18
1427 MHz	1.26
1661 MHz	1.29
1710 MHz	1.29
2200 MHz	1.26
2300 MHz	1.25
2690 MHz	1.19
3300 MHz	1.15
3800 MHz	1.16
4200 MHz	1.17
5150 MHz	1.25
5490 MHz	1.15
5730 MHz	1.23
5925 MHz	1.25

Isolation

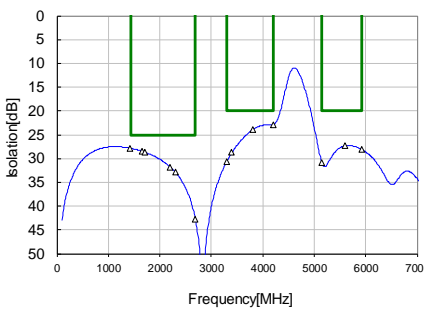

Isolation

1427 MHz	27.8 dB
1661 MHz	28.5 dB
1710 MHz	28.7 dB
2200 MHz	31.8 dB
2300 MHz	32.8 dB
2690 MHz	42.7 dB
3300 MHz	30.6 dB
3400 MHz	28.8 dB
3800 MHz	24.0 dB
4200 MHz	22.9 dB
5150 MHz	30.9 dB
5600 MHz	27.3 dB
5925 MHz	28.1 dB

Low band-Port VSWR

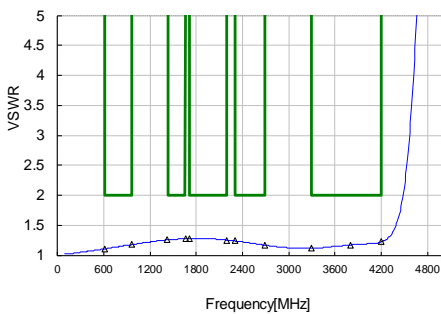

VSWR

617 MHz	1.11
960 MHz	1.18
1427 MHz	1.25
1661 MHz	1.28
1710 MHz	1.28
2200 MHz	1.25
2300 MHz	1.24
2690 MHz	1.17
3300 MHz	1.12
3800 MHz	1.17
4200 MHz	1.22

High band-Port VSWR

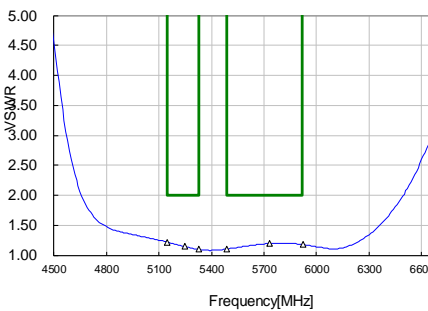

VSWR

5150 MHz	1.21
5250 MHz	1.14
5330 MHz	1.10
5490 MHz	1.10
5730 MHz	1.19
5925 MHz	1.18

DPX255925DT-5079B1

RECOMMENDED LAND PATTERN

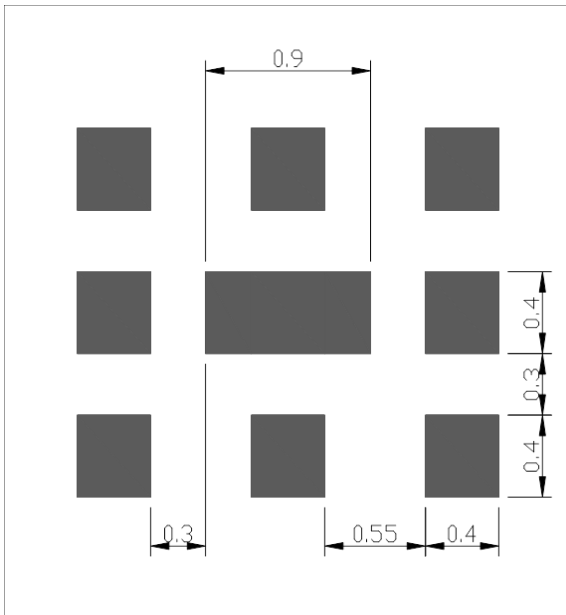

Unit: mm

EVALUATION BOARD

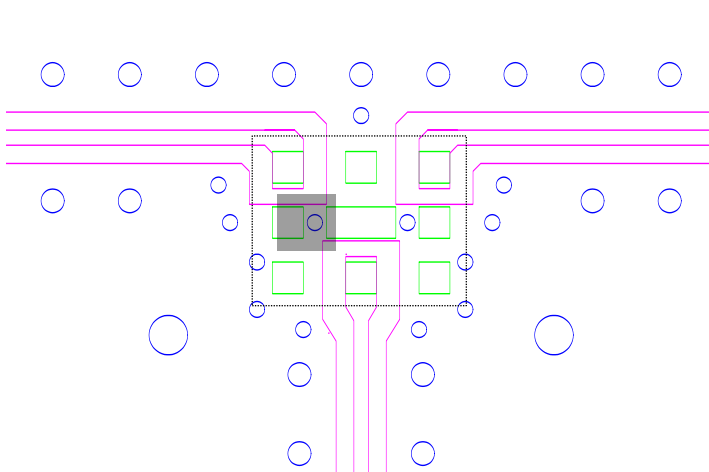

- Thru Hole
- Resist
- Surface Pattern

Material, Layer	Thickness
Top Resist	Resist
Copper Surface Pattern	0.035mm
FR-4	0.10mm
Copper Inner GND	0.018mm
FR-4	0.30mm
Copper Bottom GND	0.035mm

* Line width should be designed to match 50 ohm characteristic impedance depending on PCB material and thickness.

ENVIRONMENT INFORMATION

RoHS Statement
 RoHS Compliance

DPX255925DT-5079B1

RECOMMENDED REFLOW PROFILE

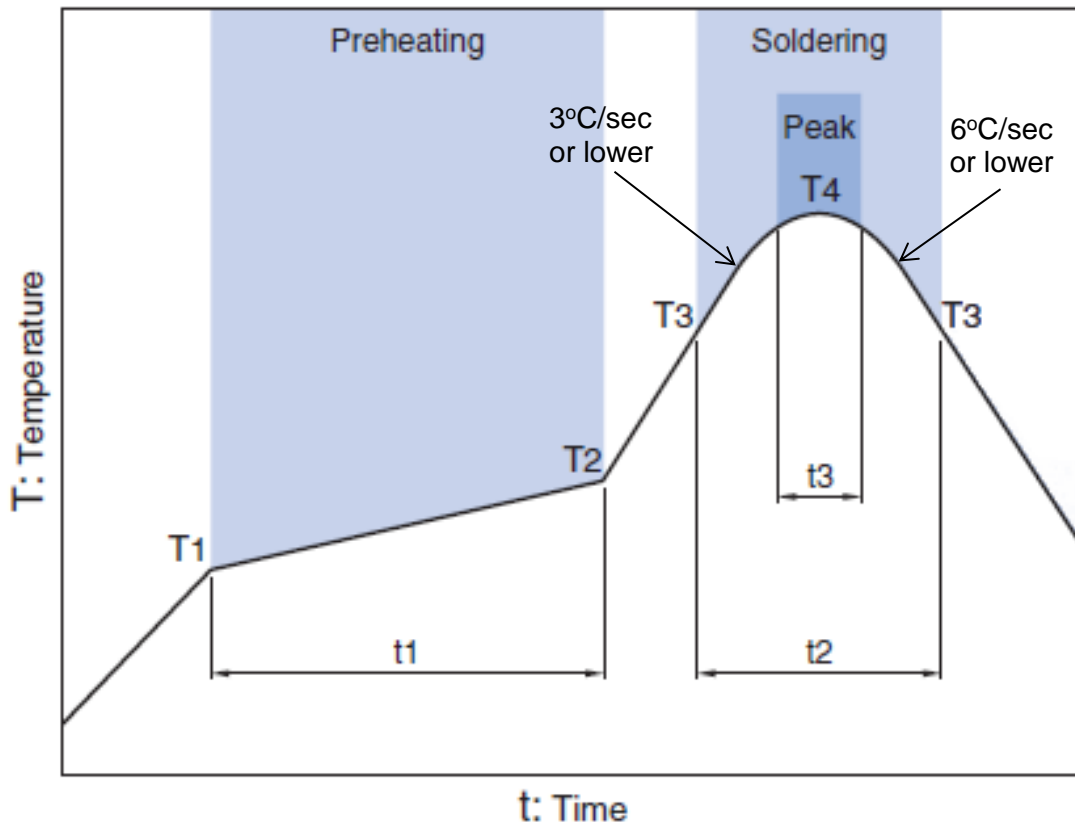

Preheating			Soldering			
Temp.		Time	Critical zone (T3 to T4)		Peak	
T1	T2	t1	T3	t2	T4	t3 *
150°C	200°C	60 to 120sec	217°C	60 to 120sec	240 to 260°C	30 sec Max

* t3 : Time within 5°C of actual peak temperature

The maximum number of reflow is 3.

Note: Lead free solder is recommended.
Recommended solder is Sn-3.0Ag-0.5Cu. (M705 by Senju Metal Industry)

DPX255925DT-5079B1**PACKAGING STYLE**

Reel Dimensions

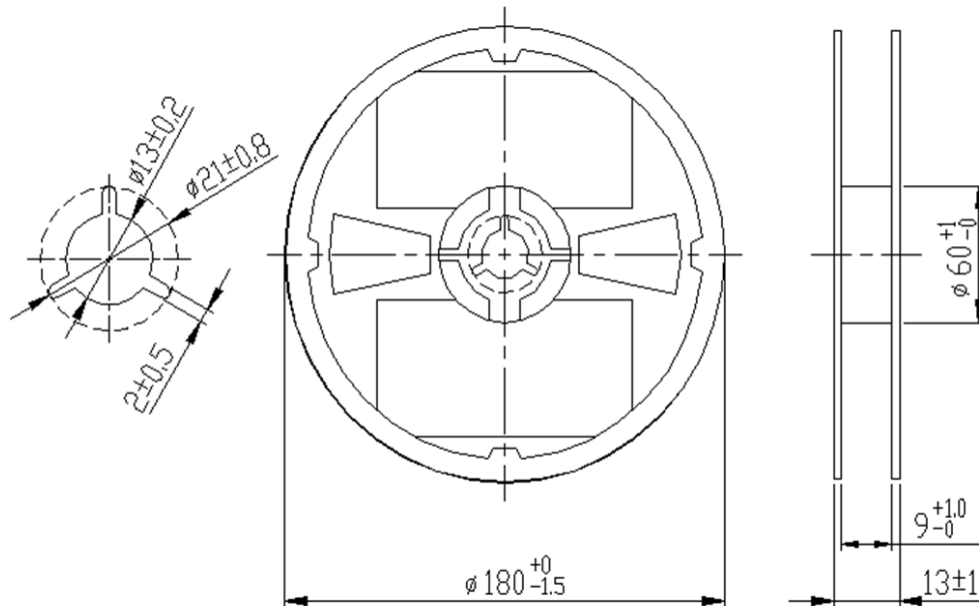

Dimensions in mm

Carrier Tape

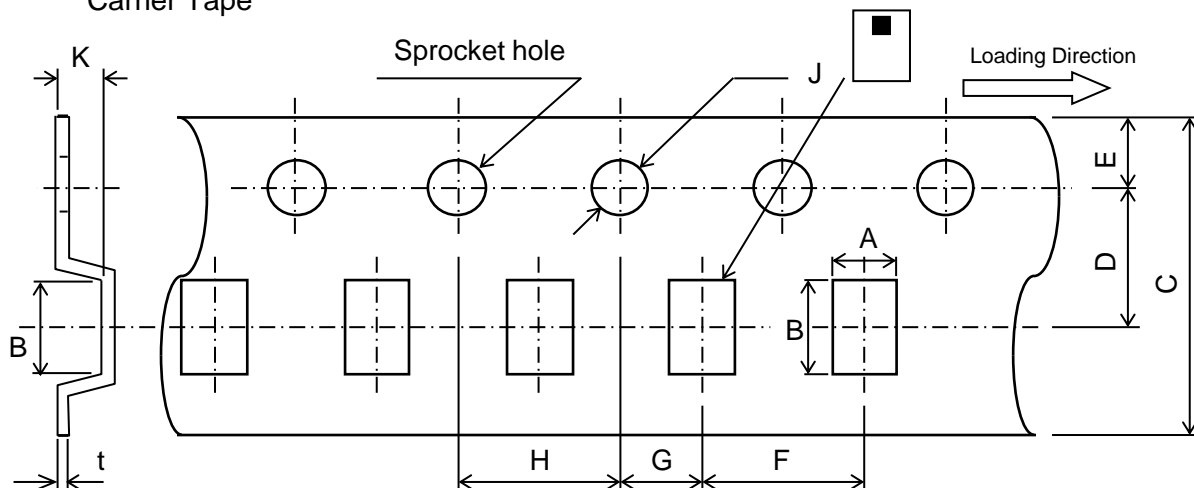

Dimensions (mm)

A	B	C	D	E	F	G	H	J	K	t
2.2	2.7	8.0	3.5	1.75	4.0	2.0	4.0	1.5	0.85	0.25
+/-0.05	+/-0.05	+0.3/-0.1	+/-0.05	+/-0.1	+/-0.1	+/-0.05	+/-0.1	+0.1/-0	MAX	+/-0.05

**STANDARD PACKAGE QUANTITY
(pieces/reel)**

2,000

All specifications are subject to change without notice.

TDK Technology - Proprietary and Confidential Information of TDK Group Companies

REMINDERS FOR USING THESE PRODUCTS

Before using these products, be sure to request the delivery specifications.

SAFETY REMINDERS

Please pay sufficient attention to the warnings for safe designing when using these products.

REMINDERS

The products listed on this catalog are intended for use in general electronic equipment (AV equipment, telecommunications equipment, home appliances, amusement equipment, computer equipment, personal equipment, office equipment, measurement equipment, industrial robots) under a normal operation and use condition.

The products are not designed or warranted to meet the requirements of the applications listed below, whose performance and/or quality require a more stringent level of safety or reliability, or whose failure, malfunction or trouble could cause serious damage to society, person or property.

Please understand that we are not responsible for any damage or liability caused by use of the products in any of the applications below or for any other use exceeding the range or conditions set forth in this catalog.

- | | |
|---|--|
| (1) Aerospace/Aviation equipment | (8) Public information-processing equipment |
| (2) Transportation equipment (cars, electric trains, ships, etc.) | (9) Military equipment |
| (3) Medical equipment | (10) Electric heating apparatus, burning equipment |
| (4) Power-generation control equipment | (11) Disaster prevention/crime prevention equipment |
| (5) Atomic energy-related equipment | (12) Safety equipment |
| (6) Seabed equipment | (13) Other applications that are not considered general-purpose applications |
| (7) Transportation control equipment | |

When using this product in general-purpose applications, you are kindly requested to take into consideration securing protection circuit/equipment or providing backup circuits, etc., to ensure higher safety.