

AN-1768 LME49600 Headphone Amplifier Evaluation Board

1 Quick Start Guide

1. Apply a $\pm 2.5\text{V}$ to $\pm 17\text{V}$ power supply's voltage to the respective "V+", "GND" and "V—" pins on JU19.
2. Apply a stereo audio signal to the RCA jacks J1 (Right) and J2 (Left) or jumpers JU1 (Right) and JU17 (Left), observing the signal input pin and the ground (GND) pin. Though not typically installed, a stereo signal can also be applied to headphone jack HPJ1.
3. Connect a load to JU14 (Left) and another load to JU15 (Right), observing the signal output pin and the ground (GND) pin. The stereo signal output is also available on the 1/8" stereo headphone jack located in the board's "OUTPUT" section.
4. Use VR1 to control the output signal amplitude.
5. Apply power. Make measurements. Plug in a pair of headphones. Enjoy.

2 Introduction

To help the user investigate and evaluate the LME49600's performance and capabilities, a fully populated demonstration board was created. Please click [here](#) for availability. This board is shown in [Figure 1](#). Connected to an external power supply ($\pm 2.5\text{V}$ to $\pm 17\text{V}$) and a signal source. The LME49600 demonstration board easily demonstrates the amplifier's features.

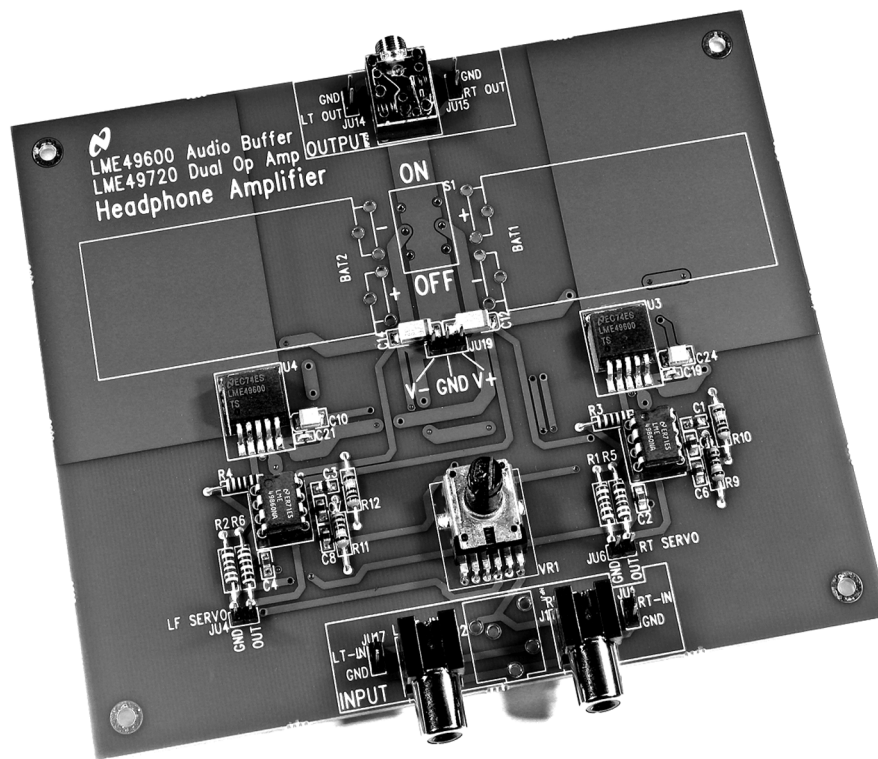

Figure 1. LME49600/LME49720 Stereo Headphone Amplifier Demonstration Board

3 General Description

The LME49600 is a high performance, low distortion high fidelity 250mA audio buffer. Whereas there are many uses for the LME49600, this application report describes a headphone amplifier circuit and associated demonstration board. Designed for use inside an operational amplifier's feedback loop, it increases output current, improves capacitive load drive, and eliminates thermal feedback.

The LME49600 offers a pin-selectable bandwidth: a low current, 110MHz bandwidth mode that consumes 8mA and a wide 180MHz bandwidth mode that consumes 15mA. In both modes the LME49600 has a nominal 2000V/ μ s slew rate. Bandwidth is easily adjusted by either leaving the BW pin unconnected, connecting a resistor between the BW pin and the V_{EE} pin or connecting the BW pin directly to the V_{EE} pin.

The LME49600 is fully protected through internal current limit and thermal shutdown.

4 Operating Conditions

Temperature Range	$-40^{\circ}\text{C} \leq T_A \leq 85^{\circ}\text{C}$
Amplifier Power Supply Voltage	$2.5\text{V} \leq V_S \leq 17\text{V}$

5 Board Features

The LME49600/LME49720 Stereo Headphone Amplifier demonstration board has all of the necessary connections, using RCA jacks, 1/8" stereo headphone jack and 0.100" headers, to apply the power supply voltage and the audio input signals. The amplified audio signal is available on both a stereo headphone jack and auxiliary output connections.

Also present on the demonstration board is a potentiometer to control the stereo output signal magnitude.

6 Schematic

Figure 2 shows the LME49600/LME49720 Stereo Headphone Amplifier Demonstration Board schematic. Table 1 is a list of the connections and their functions.

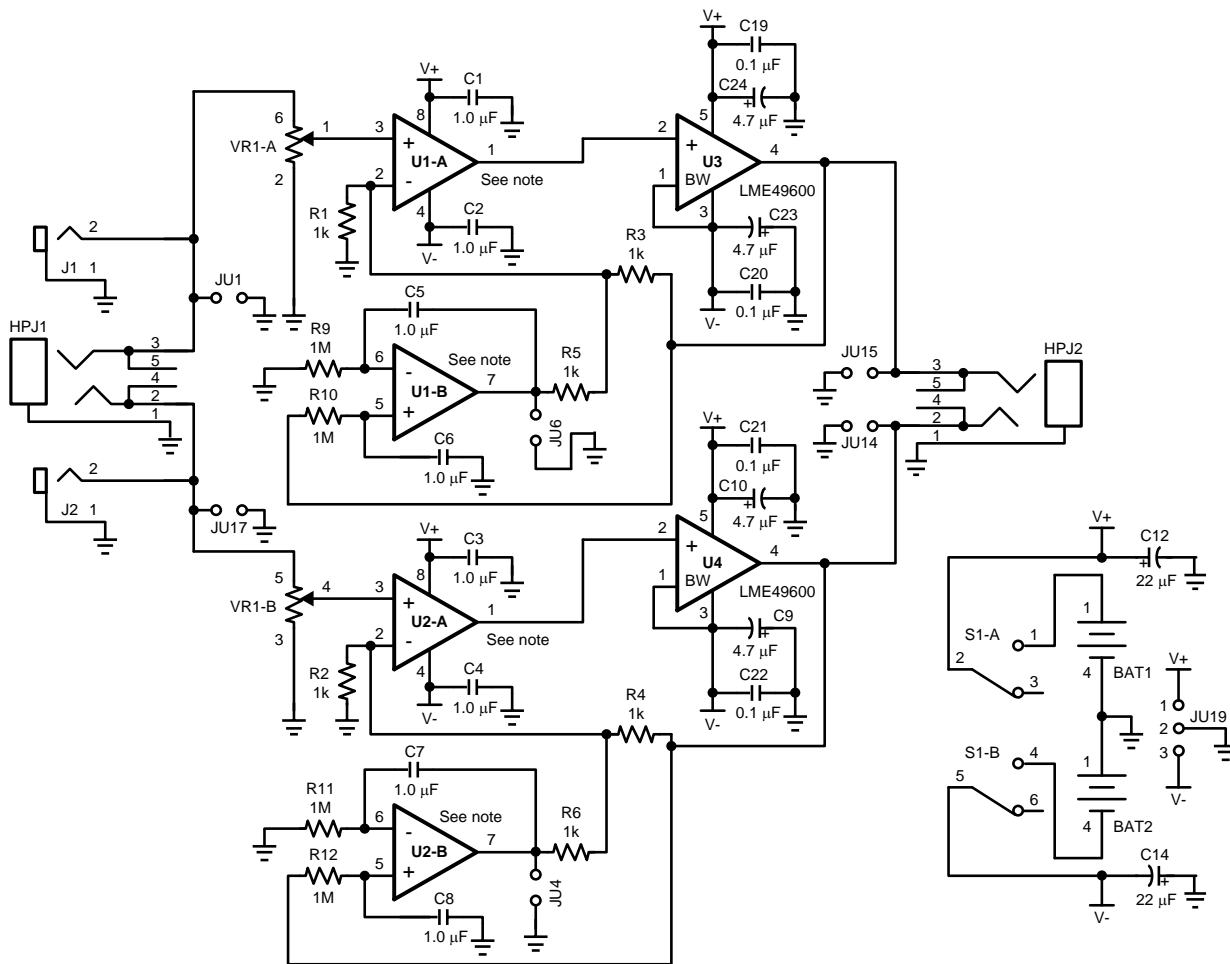

Figure 2. LME49600 Demonstration Board Schematic
Note: The LM4562, LME49720, or LME49860 can be used.

7 Connections

Connecting to the world is accomplished through a combination of RCA jacks, 1/8" stereo headphone jacks and 0.100" headers on the LME49600 demonstration board. The functions of the different headers, 1/8" headphone jacks and RCA jacks are detailed in [Table 1](#).

Table 1. LME49600 Demonstration Board Connections

Designator	Function or Use
JU17	This is the connection to the amplifier's left channel input. Apply an external signal source's positive voltage to the JU17 pin labeled "LT IN" and the signal source's ground signal to the pin labeled "GND."
J2	This is an RCA connector that parallels the pins on JU17.
HPJ1	Stereo, 1/8" headphone jack. Used for stereo signal input. Left channel input is on the tip connector and the right channel input is on the ring connector. Ground is on the sleeve connector.
J1	This is an RCA connector that parallels the pins on JU1.
JU1	This is the connection to the amplifier's right channel input. Apply an external signal source's positive voltage to the JU1 pin labeled "RT IN" and the signal source's ground signal to the pin labeled "GND."
JU19	Power supply connection. Connect an external split power supply's voltage source $\pm 2.5V$ to $\pm 17V$ to the JU19 pin labeled ("V+" and "V-") and the supply's ground source to the pin labeled "GND."
JU14	This is the connection to the amplifier's single-ended, ground-referenced left channel output. Connect the JU14 pin labeled "LT OUT" and the pin labeled "GND" to the positive and ground inputs, respectively, of an external signal measurement device. JU14's pin labeled "LT OUT" corresponds to the headphone jack's "tip" connection. J5's pin labeled "GND" corresponds to the headphone jack's "sleeve" (or ground) connection.
HPJ2	Stereo, 1/8" headphone jack. Used for stereo signal output. Left channel output is on the tip connector and the right channel output is on the ring connector. Ground is on the sleeve connector.
JU15	This is the connection to the amplifier's ground-referenced right channel output. Connect the JU15 pin labeled "RT OUT" and the pin labeled "GND" to the positive and ground inputs, respectively, of an external signal measurement device. JU15's pin labeled "RT OUT" corresponds to the headphone jack's "ring" connection. J4's pin labeled "GND" corresponds to the headphone jack's "sleeve" (or ground) connection.
JU4, JU6	These connections allow monitoring the left and right channel DC servo outputs, respectively.

8 PCB Layout Guidelines

This section provides general practical guidelines for PCB layouts that use various power and ground traces. Designers should note that these are only "rule-of-thumb" recommendations and the actual results are predicated on the final layout.

8.1 Power and Ground Circuits

Star trace routing techniques can have a major positive impact on low-level signal performance. Star trace routing refers to using individual traces that radiate from a signal point to feed power and ground to each circuit or even device.

9 Bill of Materials

RefDes	Part Description	Value	Tolerance	Rating	Package Type	Manufacturer and Part Number
BAT1– BAT2	9V Battery Terminal (male & female) [Not Installed]					KEYSTONE 593 (Female) & 594 (Male)
C1 – C8	MULTILAYER CERAMIC CAPACITOR	1.0μF	±20%	25V	805	TDK C2012X5R1E105M
C9 C10, C23 – C24	TANTALUM ELECTROLYTIC CAPACITOR	4.7μF	±10%	35V	B CASE	AVX TPSB475K035R0700
C12, C14		22μF	±20%	25V	C CASE	AVX TPSD226M025#011
C19 – C22	CERAMIC CAPACITOR	0.1μF	±10%	25V	603	TDK C1608X7R1E104K
HPJ1– HPJ2	1/8" Stereo Headphone Jack					
J1 – J2	RCA jack					
JU1, JU4, JU6, JU14, JU15, JU17	100mil pin pitch, two pin					
JU19	100mil pin pitch, three pin					
R1 – R6	1/4W resistor	1kΩ	±1%	1/4W	1/4W, Axial	YAGEO MFR-25FBF-1K00
R9 – R12	1/4W resistor	1MΩ	±1%	1/4W	1/4W, Axial	YAGEO MFR-25FBF-1M00
S1	SWITCH SLIDE DPDT [Not Installed]	DPDT				
U1, U2	LME49720 (Can also use LM4562, LME49860)					Texas Instruments LME49720 (LM4562 or LME49860)
U3, U4	LME49600					Texas Instruments LME49600
VR1	Dual gauged potentiometer	10kΩ				PANASONIC EVJ-Y00F30A14

10 Demonstration Board PCB Layout

Figure 3 through Figure 6 show the different layers used to create the LME49600 demonstration board. Figure 3 is the silkscreen that shows parts location, Figure 4 is the top layer, Figure 5 is the bottom layer, and Figure 6 is the bottom silkscreen layer.

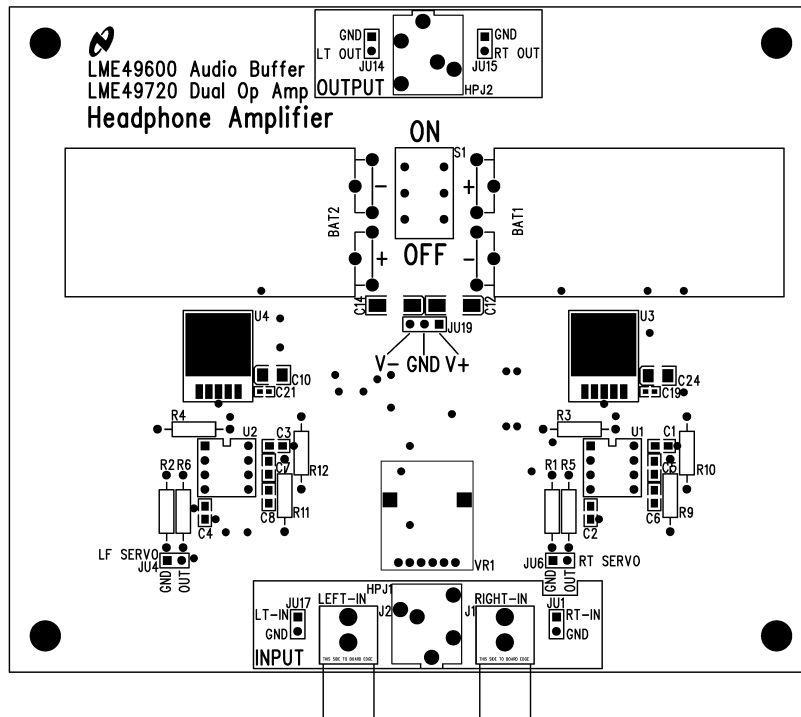

Figure 3. Top Silkscreen

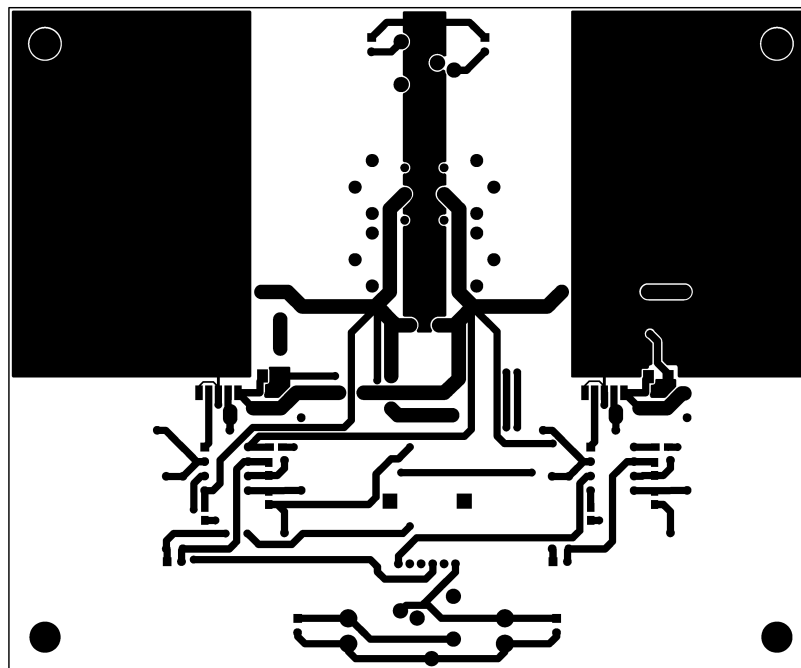

Figure 4. Top Layer

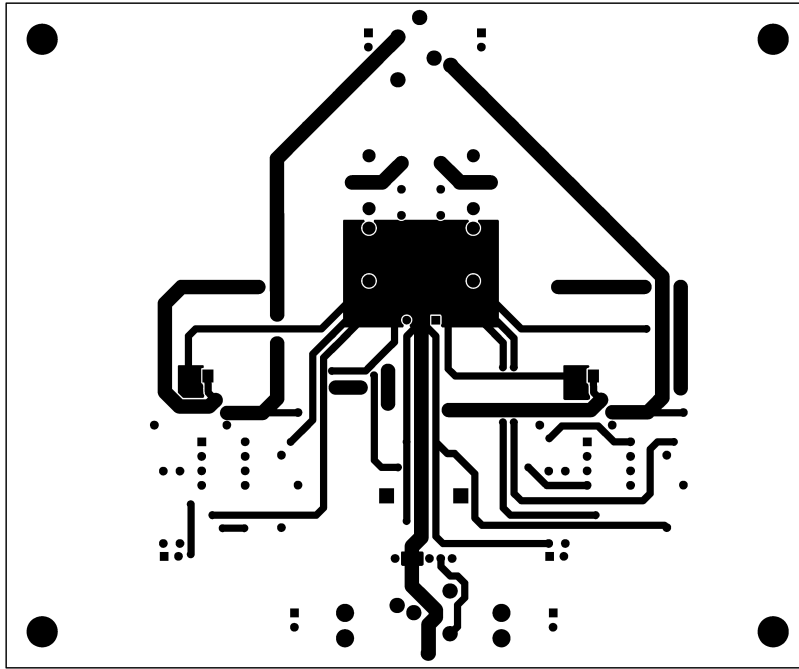

Figure 5. Bottom Layer

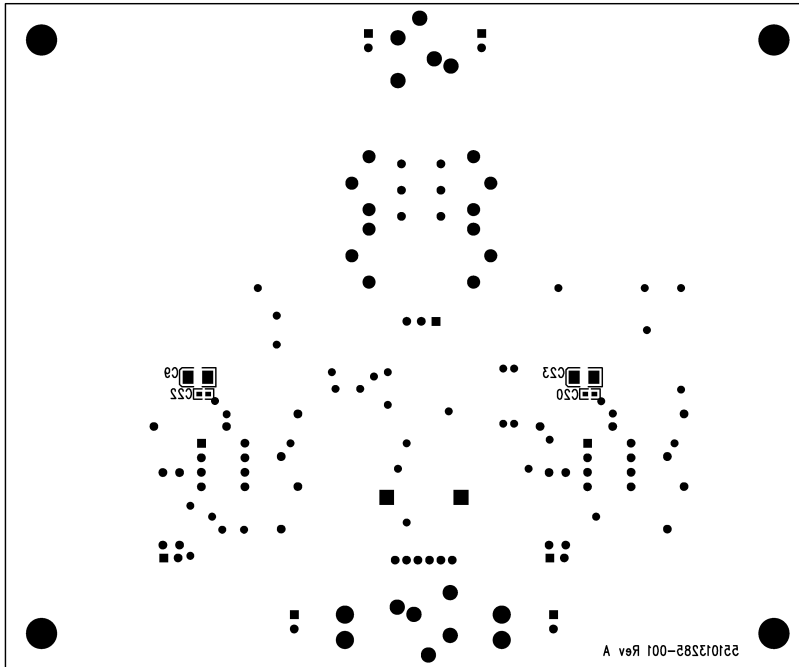

Figure 6. Bottom Silk Layer

11 Typical Performance

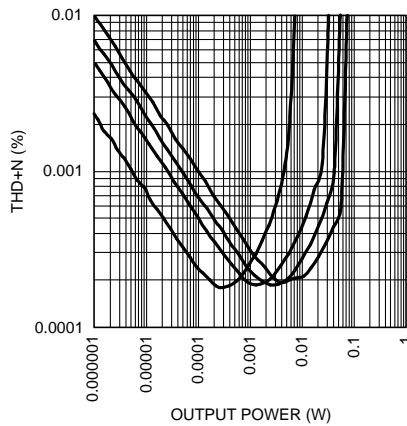

Figure 7. THD+N vs Output Power
LME49720/LME49600 headphone amplifier
into (from top to bottom at 0.1mW):
16Ω, 32Ω, 64Ω, 300Ω
($V_s = \pm 3V$, $f = 100Hz$, $22Hz \leq BW \leq 22kHz$)

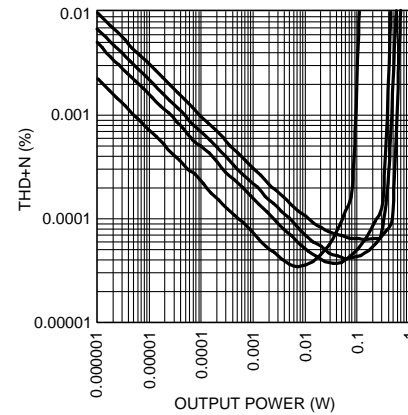

Figure 8. THD+N vs Output Power
LME49720/LME49600 headphone amplifier
into (from top to bottom at 10mW):
16Ω, 32Ω, 64Ω, 300Ω
($V_s = \pm 9V$, $f = 100Hz$, $22Hz \leq BW \leq 22kHz$)

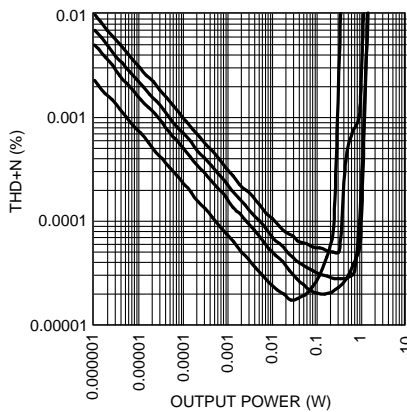

Figure 9. THD+N vs Output Power
LME49720/LME49600 headphone amplifier
into (from top to bottom at 10mW):
16Ω, 32Ω, 64Ω, 300Ω
($V_s = \pm 15V$, $f = 100Hz$, $22Hz \leq BW \leq 22kHz$)

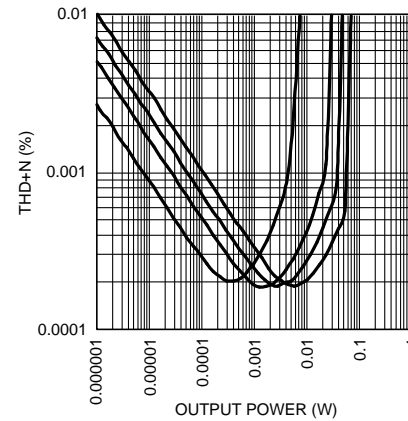

Figure 10. THD+N vs Output Power
LME49720/LME49600 headphone amplifier
into (from top to bottom at 0.1mW):
16Ω, 32Ω, 64Ω, 300Ω
($V_s = \pm 3V$, $f = 1kHz$, $400Hz \leq BW \leq 22kHz$)

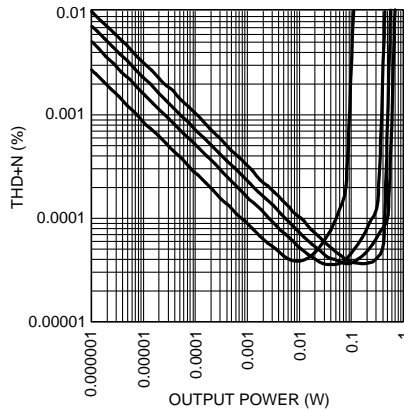

Figure 11. THD+N vs Output Power
LME49720/LME49600 headphone amplifier
into (from top to bottom at 10mW):
16Ω, 32Ω, 64Ω, 300Ω
($V_s = \pm 9V$, $f = 1kHz$, $400Hz \leq BW \leq 22kHz$)

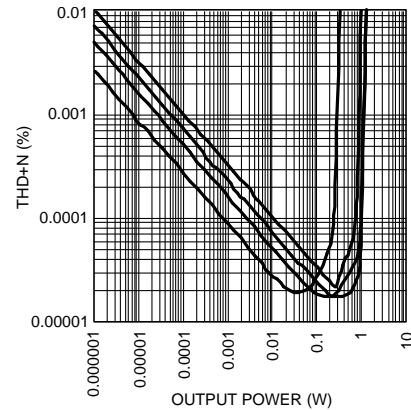

Figure 12. THD+N vs Output Power
LME49720/LME49600 headphone amplifier
into (from top to bottom at 10mW):
16Ω, 32Ω, 64Ω, 300Ω
($V_s = \pm 15V$, $f = 1kHz$, $400Hz \leq BW \leq 22kHz$)

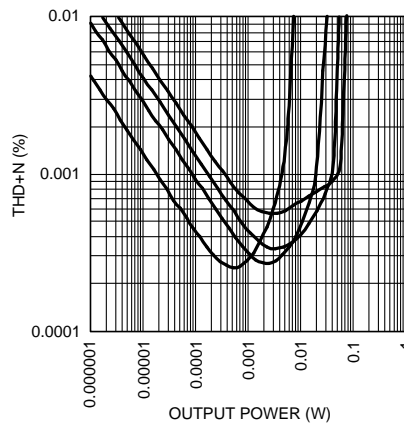

Figure 13. THD+N vs Output Power
LME49720/LME49600 headphone amplifier
into (from top to bottom at 0.1mW):
16Ω, 32Ω, 64Ω, 300Ω
($V_s = \pm 3V$, $f = 10kHz$, $400Hz \leq BW \leq 80kHz$)

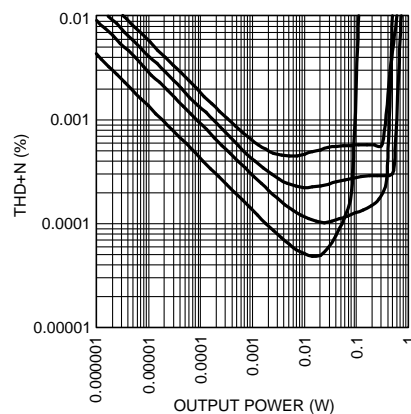

Figure 14. THD+N vs Output Power
LME49720/LME49600 headphone amplifier
into (from top to bottom at 0.1mW):
16Ω, 32Ω, 64Ω, 300Ω
($V_s = \pm 9V$, $f = 10kHz$, $400Hz \leq BW \leq 80kHz$)

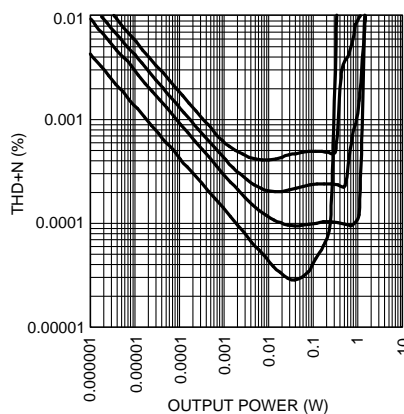

Figure 15. THD+N vs Output Power
LME49720/LME49600 headphone amplifier
into (from top to bottom at 20mW):
16Ω, 32Ω, 64Ω, 300Ω
($V_s = \pm 15V$, $f = 10kHz$, $400Hz \leq BW \leq 80kHz$)

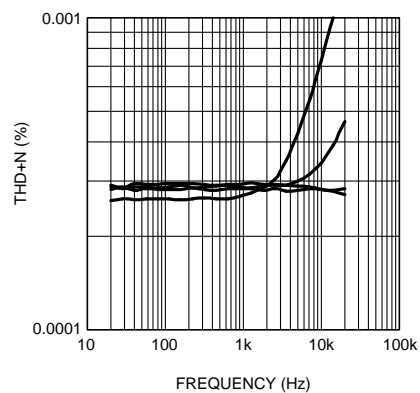

Figure 16. THD+N vs Frequency
LME49720/LME49600 headphone amplifier
into (from top to bottom at 5kHz): 16Ω at 3mW, 32Ω at
3mW, 300Ω at 0.3mW, and 64Ω at 1.5mW
($V_s = \pm 3V$, $< 10Hz \leq BW \leq 80kHz$)

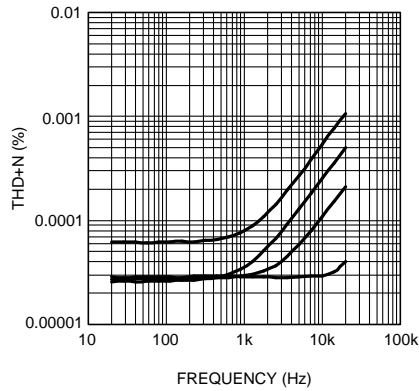

Figure 17. THD+N vs Frequency
LME49720/LME49600 headphone amplifier
 into (from top to bottom at 5kHz): 16Ω at 100mW, 32Ω at 100mW, 64Ω at 35mW, and 300Ω at 8mW
 ($V_s = \pm 9V$, $< 10\text{Hz} \leq \text{BW} \leq 80\text{kHz}$)

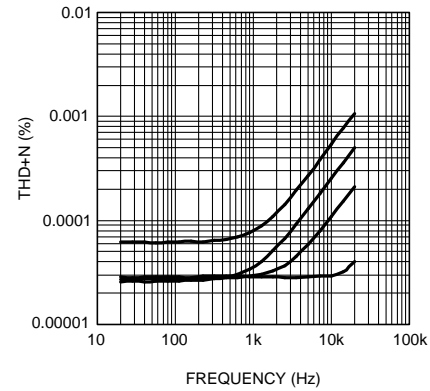

Figure 18. THD+N vs Frequency
LME49720/LME49600 headphone amplifier
 into (from top to bottom at 5kHz): 16Ω at 100mW, 32Ω at 100mW, 64Ω at 150mW, and 300Ω at 30mW
 ($V_s = \pm 15V$, $< 10\text{Hz} \leq \text{BW} \leq 80\text{kHz}$)

12 Revision History

Rev	Date	Description
1.0	02/29/08	Initial release.

IMPORTANT NOTICE

Texas Instruments Incorporated and its subsidiaries (TI) reserve the right to make corrections, enhancements, improvements and other changes to its semiconductor products and services per JESD46, latest issue, and to discontinue any product or service per JESD48, latest issue. Buyers should obtain the latest relevant information before placing orders and should verify that such information is current and complete. All semiconductor products (also referred to herein as "components") are sold subject to TI's terms and conditions of sale supplied at the time of order acknowledgment.

TI warrants performance of its components to the specifications applicable at the time of sale, in accordance with the warranty in TI's terms and conditions of sale of semiconductor products. Testing and other quality control techniques are used to the extent TI deems necessary to support this warranty. Except where mandated by applicable law, testing of all parameters of each component is not necessarily performed.

TI assumes no liability for applications assistance or the design of Buyers' products. Buyers are responsible for their products and applications using TI components. To minimize the risks associated with Buyers' products and applications, Buyers should provide adequate design and operating safeguards.

TI does not warrant or represent that any license, either express or implied, is granted under any patent right, copyright, mask work right, or other intellectual property right relating to any combination, machine, or process in which TI components or services are used. Information published by TI regarding third-party products or services does not constitute a license to use such products or services or a warranty or endorsement thereof. Use of such information may require a license from a third party under the patents or other intellectual property of the third party, or a license from TI under the patents or other intellectual property of TI.

Reproduction of significant portions of TI information in TI data books or data sheets is permissible only if reproduction is without alteration and is accompanied by all associated warranties, conditions, limitations, and notices. TI is not responsible or liable for such altered documentation. Information of third parties may be subject to additional restrictions.

Resale of TI components or services with statements different from or beyond the parameters stated by TI for that component or service voids all express and any implied warranties for the associated TI component or service and is an unfair and deceptive business practice. TI is not responsible or liable for any such statements.

Buyer acknowledges and agrees that it is solely responsible for compliance with all legal, regulatory and safety-related requirements concerning its products, and any use of TI components in its applications, notwithstanding any applications-related information or support that may be provided by TI. Buyer represents and agrees that it has all the necessary expertise to create and implement safeguards which anticipate dangerous consequences of failures, monitor failures and their consequences, lessen the likelihood of failures that might cause harm and take appropriate remedial actions. Buyer will fully indemnify TI and its representatives against any damages arising out of the use of any TI components in safety-critical applications.

In some cases, TI components may be promoted specifically to facilitate safety-related applications. With such components, TI's goal is to help enable customers to design and create their own end-product solutions that meet applicable functional safety standards and requirements. Nonetheless, such components are subject to these terms.

No TI components are authorized for use in FDA Class III (or similar life-critical medical equipment) unless authorized officers of the parties have executed a special agreement specifically governing such use.

Only those TI components which TI has specifically designated as military grade or "enhanced plastic" are designed and intended for use in military/aerospace applications or environments. Buyer acknowledges and agrees that any military or aerospace use of TI components which have **not** been so designated is solely at the Buyer's risk, and that Buyer is solely responsible for compliance with all legal and regulatory requirements in connection with such use.

TI has specifically designated certain components as meeting ISO/TS16949 requirements, mainly for automotive use. In any case of use of non-designated products, TI will not be responsible for any failure to meet ISO/TS16949.

Products

Audio	www.ti.com/audio
Amplifiers	amplifier.ti.com
Data Converters	dataconverter.ti.com
DLP® Products	www.dlp.com
DSP	dsp.ti.com
Clocks and Timers	www.ti.com/clocks
Interface	interface.ti.com
Logic	logic.ti.com
Power Mgmt	power.ti.com
Microcontrollers	microcontroller.ti.com
RFID	www.ti-rfid.com
OMAP Applications Processors	www.ti.com/omap
Wireless Connectivity	www.ti.com/wirelessconnectivity

Applications

Automotive and Transportation	www.ti.com/automotive
Communications and Telecom	www.ti.com/communications
Computers and Peripherals	www.ti.com/computers
Consumer Electronics	www.ti.com/consumer-apps
Energy and Lighting	www.ti.com/energy
Industrial	www.ti.com/industrial
Medical	www.ti.com/medical
Security	www.ti.com/security
Space, Avionics and Defense	www.ti.com/space-avionics-defense
Video and Imaging	www.ti.com/video

TI E2E Community

e2e.ti.com