

ITEM NO.	PART NUMBER	DESCRIPTION	QTY.	NOTES
1	50-00039	Connector, stereo jack, 3.5x8.0xL24.7 mm, brass, nickel plated, molding style	1	
2	30-00177	Wire, 2C BC, 28 AWG, 300V, 80C, 3.8 mm, foil + shield, PVC	1	
3	24-00036	Overmold	1	PVC, black
4	heat shrink	black	1	covers stripped end
5	heat shrink	black	1	covers shield

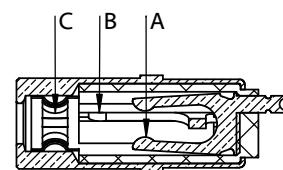
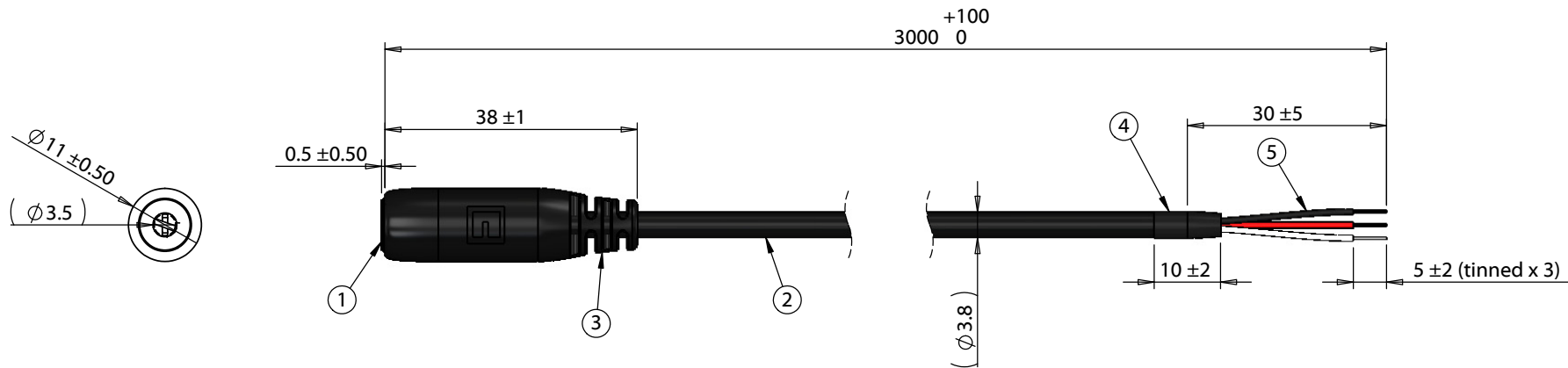

Wiring Diagram	
50-00039	wire color
A	red
B	white
C	shield

Notes:
Functionally equivalent components may be substituted

Revision:	Date:	Description:	Prepared:	Notes: RoHS compliant Function test: no open, no short circuit, no intermittent	<h1>TENSILITY</h1> <p>tel 1.541.323.3228 800 877.670.7118 fax 1.541.323.4202 web tensility.com</p>
A	2/21/2019	Initial release	Verified:		
			Dimensions are in millimeters. Tolerances: X: ± 0.5 mm X.X: ± 0.3 mm X.XX: ± 0.05 mm	Description: Cable, 3000 mm, 3.5 mm 3C 50-00039 audio jack to 5 mm tinned, 28 AWG, 30-00177 wire	Size: A Part number: 10-03208
					Scale: 1:1

5

4

3

2

1

Sheet 1 of 1