

NOTES:

1. Material : Stainless Steel
2. Finish : Glod Irridite
3. Ends : Closed and Ground
4. Total Coils : 10.000
5. Sugg. Max. Deflection : 0.220 (in)
6. Sugg. Max. Load : 2.300 (lbs)
7. All Drawing Dimensions are in Inches [mm]



\varnothing 0.030
 [0,76]
 WIRE DIA



GROUND SURFACE

1.910
 [48,51]
 LENGTH

\varnothing 0.500
 [12,70]
 O.D

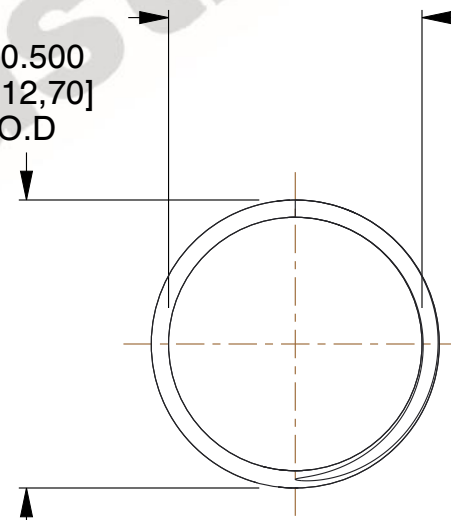

\varnothing 0.440
 [11,18]
 I.D

COMPONENT		SPRINGS	
11772 COMPRESSION SPRINGS		UNIT	INCH [mm]
		SHEET	1 of 1