

INSTALLATION INSTRUCTIONS FOR THE BASIC BOARD MOUNT PRESSURE SENSORS

50076346
Issue H

TBP Series: Compensated/Unamplified

60 mbar to 10 bar | 6 kPa to 1 MPa | 1 psi to 150 psi, Millivolt Analog Output

NBP Series: Uncompensated/Unamplified

60 mbar to 10 bar | 1 psi to 150 psi, Millivolt Analog Output

GENERAL INFORMATION

Honeywell's Basic Board Mount Pressure Sensors, TBP Series and NBP Series, are designed for food grade and non-food grade potential medical and industrial applications. These unamplified, piezoresistive silicon pressure sensors provide a ratiometric output and are either temperature compensated (TBP Series) or uncompensated (NBP Series).

CAUTION MISUSE OF GEL COATING OPTION

- **No gel coating in media path:** The input port is limited to non-corrosive, non-ionic media such as dry air and gases and should not be exposed to condensation. The gases are limited to media which are compatible with the following wetted materials of construction: high temperature polyamide, silicone, alumina ceramic, silicon, gold, and glass.
- **Silicone gel coating in media path:** The gel coated sensors use the same materials in the wetted media path but are protected from condensation by a silicone-based gel coating. The gel coating option allows use in applications where condensation can occur.

Failure to comply with these instructions may result in product damage.

SOLDERING

See soldering times and temperatures in Table 1.

CAUTION IMPROPER CLEANING

- Ensure cleaning fluids, such as appropriate alcohols or fluorinated solvents, are used based on the type of contaminants to be removed.
- Do not immerse the sensor.

Failure to comply with these instructions may result in product damage.

TABLE 2. ABSOLUTE MAXIMUM RATINGS¹

CHARACTERISTIC	MIN.	MAX.	UNIT
Supply voltage (V_{supply}) ²	-12.0	12.0	Vdc
Storage temperature	-40 [-40]	125 [257]	°C [°F]
Soldering time and temperature: lead solder temperature (DIP) peak reflow temperature (SMT, Leadless SMT)	4 s max. at 250°C [482°F] 15 s max. at 250°C [482°F]		

¹Absolute maximum ratings are the extreme limits the device will withstand without damage.

²Incorrect application of supply voltage or ground to the wrong pin may cause electrical failure.

TABLE 1. OPERATING SPECIFICATIONS

CHARACTERISTIC	MIN.	TYP.	MAX.	UNIT
TBP SERIES				
Supply voltage (V_{supply}) ^{1,2}	1.5	5.0	12.0	Vdc
Supply current (at 5.0 Vdc supply)	–	0.6	1	mA
Operating temperature range ³	-40 [-40]	–	125 [257]	°C [°F]
Compensated temperature range ⁴	0 [32]	–	85 [185]	°C [°F]
Output resistance	–	2.5	–	kOhm
NBP SERIES				
Supply voltage (V_{supply}) ^{1,2}	1.8	5.0	12.0	Vdc
Supply current (at 5.0 Vdc supply)	–	1.5	2.5	mA
Specified temperature range ⁵	-40 [-40]	–	125 [257]	°C [°F]
Accuracy ⁶	–	–	±0.25	%FSS BFSL ⁷
Input resistance	2.4	3.0	5.5	kOhm
Thermal effect on resistance (TER) ⁸	1200	–	3200	ppm/°C

¹Ratiometricity of the sensor (the ability of the device output to scale to the supply voltage) is achieved within the specified operating voltage.

²Incorrect application of supply voltage or ground to the wrong pin may cause electrical failure.

³**Operating temperature range:** The temperature range over which the sensor produces an output proportional to pressure.

⁴**Compensated temperature range:** The temperature range over which the sensor produces an output proportional to pressure within the specified performance limits.

⁵**Specified temperature range:** The temperature range over which the sensor will produce an output proportional to pressure within the specified performance limits.

⁶**Accuracy:** The maximum deviation in output from a Best Fit Straight Line (BFSL) fitted to the output measured over the pressure range at 25°C [77°F]. Includes all errors due to pressure non-linearity, pressure hysteresis, and non-repeatability.

⁷**Full Scale Span (FSS):** The algebraic difference between the output signal measured at the maximum and minimum limits of the pressure range. (See Figure 2 for pressure ranges.)

⁸**TER (Thermal Effect on Resistance):** The deviation in input resistance due to change in temperature over the specified temperature range, relative to input resistance measured at 25°C [77°F].

TBP SERIES AND NBP SERIES BASIC BOARD MOUNT PRESSURE SENSORS

Issue H
50076346

TABLE 2. PRESSURE REFERENCE TYPES

PRESSURE TYPE	DESCRIPTION
Absolute	Output is proportional to the difference between applied pressure and a built-in reference to vacuum. Reference pressure is absolute zero pressure (full vacuum).
Differential	Output is proportional to the difference between the pressures applied to each port (Port 1 - Port 2).
Gage	Output is proportional to the difference between applied pressure and atmospheric (ambient) pressure. Reference pressure is atmospheric pressure.

TABLE 3. ENVIRONMENTAL SPECIFICATIONS

CHARACTERISTIC	PARAMETER
Humidity: all external surfaces internal surfaces of silicone gel coating option internal surfaces of no gel coating option	0 %RH to 95 %RH, non-condensing 0 %RH to 100 %RH, condensing 0 %RH to 95 %RH, non-condensing
Vibration	MIL-STD-202G, Method 204D, Condition B (15 g, 10 Hz to 2 kHz)
Shock	MIL-STD-202G, Method 213B, Condition C (100 g, 6 ms duration)
Life ¹	1 million pressure cycles min.
ESD	MIL-STD-883 Method 3015.7
Solder reflow	J-STD-020E, MSL 1, unlimited storage life
Certification (silicone gel coating option: Port 1 only)	NSF- 169, BPA Free, LFGB

¹Life may vary depending on specific application in which the sensor is utilized.



TABLE 4. WETTED MATERIALS¹

COMPONENT	PRESSURE PORT 1 (P1)		PPRESSURE PORT 2 (P2)
	NO GEL COATING IN MEDIA PATH	SILICONE GEL COATING IN MEDIA PATH (FOOD GRADE)	
Ports and covers	high temperature polyamide		
Substrate	alumina ceramic	–	alumina ceramic
Adhesives	epoxy, silicone	epoxy, silicone gel	epoxy, silicone
Electronic components	silicon, gold, glass, solder, aluminum	304SST	silicon

¹Contact Honeywell Customer Service for detailed material information.

TBP SERIES AND NBP SERIES

BASIC BOARD MOUNT PRESSURE SENSORS

Issue H
50076346

TABLE 5. TBP SERIES PRESSURE RANGE SPECIFICATIONS FOR 60 MBAR TO 10 BAR

Pressure Range Order Code (see Figure 1)	Pressure Range		Unit	Over-Pressure ¹		Burst Pressure ²		Common Mode Pressure ³	Pressure Accuracy (%FSS) ⁴	Offset (mV/V) ⁵	Full Scale Span (mV/V) ⁶			Thermal Effect on Offset (%FSS) ⁷		Thermal Effect on Span (%FSS) ⁸		Long-Term Stability 1000 hr at 25°C (%FSS)	Thermal Hysteresis No Gel Option (%FSS) ⁹	Thermal Hysteresis Silicone Gel Option (%FSS) ⁹
	Pmin.	Pmax.		Port 1	Port 2	Port 1	Port 2				Min.	Nom.	Max.	10°C to 50°C	0°C to 85°C	10°C to 50°C	0°C to 85°C			
GAGE																				
060MG	0	60	mbar	872	–	1370	–	–	±0.20	±0.075	1.23	1.30	1.40	±1.15	±2.35	±1.00	±2.00	±0.45	±0.40	±0.60
100MG	0	100	mbar	872	–	1370	–	–	±0.20	±0.075	2.06	2.20	2.33	±0.70	±1.40	±1.00	±2.00	±0.30	±0.25	±0.35
160MG	0	160	mbar	2000	–	4000	–	–	±0.15	±0.12	2.18	2.30	2.46	±1.65	±3.30	±0.75	±2.00	±0.55	±0.35	±0.55
250MG	0	250	mbar	2000	–	4000	–	–	±0.15	±0.12	3.41	3.65	3.85	±1.05	±2.10	±0.75	±2.00	±0.35	±0.20	±0.35
400MG	0	400	mbar	2000	–	4000	–	–	±0.15	±0.12	5.45	5.80	6.15	±0.65	±1.30	±0.75	±2.00	±0.20	±0.15	±0.20
600MG	0	600	mbar	4000	–	8000	–	–	±0.15	±0.075	2.94	3.05	3.18	±0.85	±1.65	±0.50	±1.25	±0.40	±0.15	±0.35
001BG	0	1	bar	4	–	8	–	–	±0.15	±0.075	4.90	5.10	5.30	±0.50	±1.00	±0.50	±1.25	±0.25	±0.10	±0.20
1.6BG	0	1.6	bar	4	–	8	–	–	±0.15	±0.075	7.84	8.15	8.48	±0.30	±0.65	±0.50	±1.25	±0.15	±0.10	±0.15
2.5BG	0	2.5	bar	8	–	17	–	–	±0.15	±0.075	6.10	6.35	6.59	±0.40	±0.80	±0.50	±1.50	±0.20	±0.10	±0.15
004BG	0	4	bar	10	–	17	–	–	±0.15	±0.075	5.57	5.80	6.04	±0.50	±1.00	±0.50	±1.25	±0.25	±0.10	±0.20
006BG	0	6	bar	17	–	21	–	–	±0.15	±0.075	5.08	5.30	5.54	±0.65	±1.00	±0.50	±1.00	±0.25	±0.15	±0.25
010BG	0	10	bar	17	–	21	–	–	±0.15	±0.075	8.47	8.85	9.22	±0.40	±0.60	±0.50	±1.00	±0.15	±0.10	±0.15
DIFFERENTIAL																				
060MD	-60	60	mbar	872	872	1370	1370	10000	±0.20	±0.075	2.46	2.60	2.80	±0.60	±1.20	±1.00	±2.00	±0.25	±0.20	±0.30
100MD	-100	100	mbar	872	872	1370	1370	10000	±0.20	±0.075	4.12	4.40	4.66	±0.35	±0.70	±1.00	±2.00	±0.15	±0.15	±0.20
160MD	-160	160	mbar	2000	2000	4000	4000	10000	±0.15	±0.12	4.36	4.60	4.92	±0.85	±1.65	±0.75	±2.00	±0.30	±0.20	±0.30
250MD	-250	250	mbar	2000	2000	4000	4000	10000	±0.15	±0.12	6.82	7.30	7.70	±0.55	±1.05	±0.75	±2.00	±0.20	±0.10	±0.20
400MD	-400	400	mbar	2000	2000	4000	4000	10000	±0.15	±0.12	10.90	11.60	12.30	±0.35	±0.65	±0.75	±2.00	±0.10	±0.10	±0.10
600MD	-600	600	mbar	4000	4000	8000	8000	10000	±0.15	±0.075	5.88	6.10	6.36	±0.45	±0.85	±0.50	±1.25	±0.20	±0.10	±0.20
001BD	-1	1	bar	4	4	8	8	10	±0.15	±0.075	9.80	10.20	10.60	±0.25	±0.50	±0.50	±1.25	±0.15	±0.10	±0.10
1.6BD	-1.6	1.6	bar	4	4	8	8	10	±0.15	±0.075	15.68	16.30	16.96	±0.15	±0.35	±0.50	±1.25	±0.10	±0.10	±0.10
2.5BD	-2.5	2.5	bar	8	8	17	17	10	±0.15	±0.075	12.20	12.70	13.18	±0.20	±0.40	±0.50	±1.50	±0.10	±0.10	±0.10
004BD	-4	4	bar	10	10	17	17	15	±0.15	±0.075	11.14	11.60	12.08	±0.25	±0.50	±0.50	±1.25	±0.15	±0.10	±0.10

¹**Overpressure:** The maximum pressure which may safely be applied to the product for it to remain within specifications once pressure is returned to the operating pressure range. Exposure to higher pressures may cause permanent damage to the product. Unless otherwise specified, this applies to all available pressure ports at any temperature within the operating temperature range.

²**Burst pressure:** The maximum pressure that may be applied to the specified port (P1 or P2) of the product without causing escape of pressure media. Product should not be expected to function after exposure to any pressure beyond the burst pressure.

³**Common mode pressure:** The maximum pressure that can be applied simultaneously to both ports of a differential pressure sensor without causing changes in specified performance.

⁴**Accuracy:** The maximum deviation in output from a Best Fit Straight Line (BFSL) fitted to the output measured over the pressure range at 25°C. Includes all errors due to pressure non-linearity, pressure hysteresis, and non-repeatability.

⁵**Offset:** The output signal obtained when the reference pressure is applied to all available pressure ports. Also known as “null” or “zero”.

⁶**Full Scale Span:** The algebraic difference between the output signal measured at the maximum and minimum limits of the pressure range (see Figure 1 for pressure ranges).

⁷**Thermal effect on offset:** The deviation in offset due to changes in temperature over the compensated temperature range, relative to offset measured at 25°C.

⁸**Thermal effect on span:** The deviation in full scale span due to changes in temperature over the compensated temperature range, relative to full scale span measured at 25°C.

⁹**Thermal hysteresis:** The maximum difference between output readings when the same temperature is reached consecutively, under the same operating conditions, with temperature approaching from opposite directions within the operating temperature range. Validated over the full operating temperature and pressure ranges using a ~5°C/ minute ramp and 30 minute dwell. Application performance may be affected by thermal mass of end user system.

TBP SERIES AND NBP SERIES BASIC BOARD MOUNT PRESSURE SENSORS

Issue H
50076346

TABLE 6. TBP SERIES PRESSURE RANGE SPECIFICATIONS FOR 6 KPA TO 1 MPA

Pressure Range Order Code (see Figure 1)	Pressure Range		Unit	Over-Pressure ¹		Burst Pressure ²		Common Mode Pressure ³	Pressure Accuracy (%FSS) ⁴	Offset (mV/V) ⁵	Full Scale Span (mV/V) ⁶			Thermal Effect on Offset (%FSS) ⁷		Thermal Effect on Span (%FSS) ⁸		Long-Term Stability 1000 hr at 25°C (%FSS)	Thermal Hysteresis No Gel Option (%FSS) ⁹	Thermal Hysteresis Silicone Gel Option (%FSS) ⁹
	Pmin.	Pmax.		Port 1	Port 2	Port 1	Port 2				Min.	Nom.	Max.	10°C to 50°C	0°C to 85°C	10°C to 50°C	0°C to 85°C			
GAGE																				
006KG	0	6	kPa	87	–	137	–	–	±0.20	±0.075	1.23	1.30	1.40	±1.15	±2.35	±1.00	±2.00	±0.45	±0.40	±0.60
010KG	0	10	kPa	87	–	137	–	–	±0.20	±0.075	2.06	2.20	2.33	±0.70	±1.40	±1.00	±2.00	±0.30	±0.25	±0.35
016KG	0	16	kPa	200	–	400	–	–	±0.15	±0.12	2.18	2.30	2.46	±1.65	±3.30	±0.75	±2.00	±0.55	±0.35	±0.55
025KG	0	25	kPa	200	–	400	–	–	±0.15	±0.12	3.41	3.65	3.85	±1.05	±2.10	±0.75	±2.00	±0.35	±0.20	±0.35
040KG	0	40	kPa	200	–	400	–	–	±0.15	±0.12	5.45	5.80	6.15	±0.65	±1.30	±0.75	±2.00	±0.20	±0.15	±0.20
060KG	0	60	kPa	400	–	800	–	–	±0.15	±0.075	2.94	3.05	3.18	±0.85	±1.65	±0.50	±1.25	±0.40	±0.15	±0.35
100KG	0	100	kPa	400	–	800	–	–	±0.15	±0.075	4.90	5.10	5.30	±0.50	±1.00	±0.50	±1.25	±0.25	±0.10	±0.20
160KG	0	160	kPa	400	–	800	–	–	±0.15	±0.075	7.84	8.15	8.48	±0.30	±0.65	±0.50	±1.25	±0.15	±0.10	±0.15
250KG	0	250	kPa	800	–	1700	–	–	±0.15	±0.075	6.10	6.35	6.59	±0.40	±0.80	±0.50	±1.50	±0.20	±0.10	±0.15
400KG	0	400	kPa	1000	–	1700	–	–	±0.15	±0.075	5.57	5.80	6.04	±0.50	±1.00	±0.50	±1.25	±0.25	±0.10	±0.20
600KG	0	600	kPa	1700	–	2100	–	–	±0.15	±0.075	5.08	5.30	5.54	±0.65	±1.00	±0.50	±1.00	±0.25	±0.15	±0.25
001GG	0	1	MPa	1.70	–	2.10	–	–	±0.15	±0.075	8.47	8.85	9.22	±0.40	±0.60	±0.50	±1.00	±0.15	±0.10	±0.15
DIFFERENTIAL																				
006KD	-6	6	kPa	87	87	137	137	1000	±0.20	±0.075	2.46	2.60	2.80	±0.60	±1.20	±1.00	±2.00	±0.25	±0.20	±0.30
010KD	-10	10	kPa	87	87	137	137	1000	±0.20	±0.075	4.12	4.40	4.66	±0.35	±0.70	±1.00	±2.00	±0.15	±0.15	±0.20
016KD	-16	16	kPa	200	200	400	400	1000	±0.15	±0.12	4.36	4.60	4.92	±0.85	±1.65	±0.75	±2.00	±0.30	±0.20	±0.30
025KD	-25	25	kPa	200	200	400	400	1000	±0.15	±0.12	6.82	7.30	7.70	±0.55	±1.05	±0.75	±2.00	±0.20	±0.10	±0.20
040KD	-40	40	kPa	200	200	400	400	1000	±0.15	±0.12	10.90	11.60	12.30	±0.35	±0.65	±0.75	±2.00	±0.10	±0.10	±0.10
060KD	-60	60	kPa	400	400	800	800	1000	±0.15	±0.075	5.88	6.10	6.36	±0.45	±0.85	±0.50	±1.25	±0.20	±0.10	±0.20
100KD	-100	100	kPa	400	400	800	800	1000	±0.15	±0.075	9.80	10.20	10.60	±0.25	±0.50	±0.50	±1.25	±0.15	±0.10	±0.10
160KD	-160	160	kPa	400	400	800	800	1000	±0.15	±0.075	15.68	16.30	16.96	±0.15	±0.35	±0.50	±1.25	±0.10	±0.10	±0.10
250KD	-250	250	kPa	800	800	1700	1700	1000	±0.15	±0.075	12.20	12.70	13.18	±0.20	±0.40	±0.50	±1.50	±0.10	±0.10	±0.10
400KD	-400	400	kPa	1000	1000	1700	1700	1500	±0.15	±0.075	11.14	11.60	12.08	±0.25	±0.50	±0.50	±1.25	±0.15	±0.10	±0.10

¹**Overpressure:** The maximum pressure which may safely be applied to the product for it to remain within specifications once pressure is returned to the operating pressure range. Exposure to higher pressures may cause permanent damage to the product. Unless otherwise specified, this applies to all available pressure ports at any temperature within the operating temperature range.

²**Burst pressure:** The maximum pressure that may be applied to the specified port (P1 or P2) of the product without causing escape of pressure media. Product should not be expected to function after exposure to any pressure beyond the burst pressure.

³**Common mode pressure:** The maximum pressure that can be applied simultaneously to both ports of a differential pressure sensor without causing changes in specified performance.

⁴**Accuracy:** The maximum deviation in output from a Best Fit Straight Line (BFSL) fitted to the output measured over the pressure range at 25°C. Includes all errors due to pressure non-linearity, pressure hysteresis, and non-repeatability.

⁵**Offset:** The output signal obtained when the reference pressure is applied to all available pressure ports. Also known as “null” or “zero”.

⁶**Full Scale Span:** The algebraic difference between the output signal measured at the maximum and minimum limits of the pressure range (see Figure 1 for pressure ranges).

⁷**Thermal effect on offset:** The deviation in offset due to changes in temperature over the compensated temperature range, relative to offset measured at 25°C.

⁸**Thermal effect on span:** The deviation in full scale span due to changes in temperature over the compensated temperature range, relative to full scale span measured at 25°C.

⁹**Thermal hysteresis:** The maximum difference between output readings when the same temperature is reached consecutively, under the same operating conditions, with temperature approaching from opposite directions within the operating temperature range. Validated over the full operating temperature and pressure ranges using a ~5°C/ minute ramp and 30 minute dwell. Application performance may be affected by thermal mass of end user system.

TBP SERIES AND NBP SERIES

BASIC BOARD MOUNT PRESSURE SENSORS

Issue H
50076346

TABLE 7. TBP SERIES PRESSURE RANGE SPECIFICATIONS FOR 1 PSI TO 150 PSI

Pressure Range Order Code (see Figure 1)	Pressure Range		Unit	Over-Pressure ¹		Burst Pressure ²		Common Mode Pressure ³	Pressure Accuracy (%FSS) ⁴	Offset (mV/V) ⁵	Full Scale Span (mV/V) ⁶			Thermal Effect on Offset (%FSS) ⁷		Thermal Effect on Span (%FSS) ⁸		Long-Term Stability 1000 hr at 25°C (%FSS)	Thermal Hysteresis No Gel Option (%FSS) ⁹	Thermal Hysteresis Silicone Gel Option (%FSS) ⁹
	Pmin.	Pmax.		Port 1	Port 2	Port 1	Port 2				Min.	Nom.	Max.	10°C to 50°C	0°C to 85°C	10°C to 50°C	0°C to 85°C			
GAGE																				
001PG	0	1	psi	12.7	–	20	–	–	±0.20	±0.075	1.42	1.50	1.61	±1.00	±2.05	±1.00	±2.00	±0.40	±0.35	±0.50
005PG	0	5	psi	30	–	60	–	–	±0.15	±0.12	4.70	5.00	5.30	±0.75	±1.50	±0.75	±2.00	±0.25	±0.15	±0.25
015PG	0	15	psi	60	–	115	–	–	±0.15	±0.075	5.06	5.25	5.49	±0.50	±0.95	±0.50	±1.25	±0.25	±0.10	±0.20
030PG	0	30	psi	115	–	245	–	–	±0.15	±0.075	5.05	5.25	5.45	±0.50	±0.95	±0.50	±1.50	±0.25	±0.10	±0.20
060PG	0	60	psi	145	–	245	–	–	±0.15	±0.075	5.76	6.00	6.24	±0.50	±0.95	±0.50	±1.25	±0.25	±0.10	±0.20
100PG	0	100	psi	245	–	300	–	–	±0.15	±0.075	5.83	6.10	6.36	±0.60	±0.85	±0.50	±1.00	±0.25	±0.10	±0.25
150PG	0	150	psi	245	–	300	–	–	±0.15	±0.075	8.75	9.15	9.54	±0.40	±0.60	±0.50	±1.00	±0.15	±0.10	±0.15
DIFFERENTIAL																				
001PD	-1	1	psi	12.7	12.7	20	20	150	±0.20	±0.075	2.84	3.00	3.22	±0.50	±1.05	±1.00	±2.00	±0.20	±0.20	±0.25
005PD	-5	5	psi	30	30	60	60	150	±0.15	±0.12	9.40	10.00	10.60	±0.40	±0.75	±0.75	±2.00	±0.15	±0.10	±0.15
015PD	-15	15	psi	60	60	115	115	150	±0.15	±0.075	10.12	10.50	10.98	±0.25	±0.50	±0.50	±1.25	±0.15	±0.10	±0.10
030PD	-30	30	psi	115	115	245	245	150	±0.15	±0.075	10.10	10.50	10.90	±0.25	±0.50	±0.50	±1.50	±0.15	±0.10	±0.10
060PD	-60	60	psi	145	145	245	245	250	±0.15	±0.075	11.52	12.00	12.48	±0.25	±0.50	±0.50	±1.25	±0.15	±0.10	±0.10

¹**Overpressure:** The maximum pressure which may safely be applied to the product for it to remain within specifications once pressure is returned to the operating pressure range. Exposure to higher pressures may cause permanent damage to the product. Unless otherwise specified, this applies to all available pressure ports at any temperature within the operating temperature range.

²**Burst pressure:** The maximum pressure that may be applied to the specified port (P1 or P2) of the product without causing escape of pressure media. Product should not be expected to function after exposure to any pressure beyond the burst pressure.

³**Common mode pressure:** The maximum pressure that can be applied simultaneously to both ports of a differential pressure sensor without causing changes in specified performance.

⁴**Accuracy:** The maximum deviation in output from a Best Fit Straight Line (BFSL) fitted to the output measured over the pressure range at 25°C. Includes all errors due to pressure non-linearity, pressure hysteresis, and non-repeatability.

⁵**Offset:** The output signal obtained when the reference pressure is applied to all available pressure ports. Also known as “null” or “zero”.

⁶**Full Scale Span:** The algebraic difference between the output signal measured at the maximum and minimum limits of the pressure range (see Figure 1 for pressure ranges).

⁷**Thermal effect on offset:** The deviation in offset due to changes in temperature over the compensated temperature range, relative to offset measured at 25°C.

⁸**Thermal effect on span:** The deviation in full scale span due to changes in temperature over the compensated temperature range, relative to full scale span measured at 25°C.

⁹**Thermal hysteresis:** The maximum difference between output readings when the same temperature is reached consecutively, under the same operating conditions, with temperature approaching from opposite directions within the operating temperature range. Validated over the full operating temperature and pressure ranges using a ~5°C/ minute ramp and 30 minute dwell. Application performance may be affected by thermal mass of end user system.

TABLE 8. NBP SERIES PRESSURE RANGE SPECIFICATIONS FOR 60 MBAR TO 10 BAR

Pressure Range (see Figure 2)	Pressure Range		Unit	Over-Pressure ¹		Burst Pressure ²		Common Mode Pressure ³	Offset ⁴ (mV/V)		Sensitivity (mV/V/Full Scale Span)			Thermal Effect on Offset (%FSS/25°C) ⁵			Thermal Effect on Span (%FSS/25°C) ⁶		
	P.min.	P.max.		Port 1	Port 2	Port 1	Port 2		Min.	Max.	Min.	Nom.	Max.	Min.	Nom.	Max.	Min.	Nom.	Max.
ABSOLUTE																			
001BA	0	1	bar	2	–	4	–	–	-7.0	7.0	10.0	15.0	20.0	-1.5	-0.5	1.5	-6.0	-5.0	-3.5
1.6BA	0	1.6	bar	4	–	8	–	–	-7.0	7.0	12.0	16.0	20.0	-1.5	-0.5	1.5	-6.0	-5.0	-3.5
2.5BA	0	2.5	bar	4	–	8	–	–	-7.0	7.0	18.8	25.0	31.3	-1.0	-0.3	1.0	-6.0	-5.0	-3.5
004BA	0	4	bar	8	–	16	–	–	-7.0	7.0	16.8	20.0	23.2	-1.0	-0.3	1.0	-6.0	-5.0	-3.5
006BA	0	6	bar	16	–	20	–	–	-7.0	7.0	12.6	15.0	17.4	-1.5	-0.4	1.5	-6.0	-5.0	-3.5
010BA	0	10	bar	16	–	20	–	–	-7.0	7.0	21.0	25.0	29.0	-1.0	-0.3	1.0	-6.0	-5.0	-3.5
GAGE																			
060MG	0	60	mbar	850	–	1400	–	–	-8.5	8.5	3.9	5.7	7.4	-3.5	-1.2	3.5	-6.0	-5.0	-3.5
100MG	0	100	mbar	850	–	1400	–	–	-8.5	8.5	6.6	9.4	12.3	-2.1	-0.7	2.1	-6.0	-5.0	-3.5
160MG	0	160	mbar	850	–	1400	–	–	-8.5	8.5	10.5	15.1	19.7	-1.3	-0.4	1.3	-6.0	-5.0	-3.5
250MG	0	250	mbar	1800	–	3000	–	–	-8.5	8.5	7.3	10.9	14.5	-2.1	-0.7	2.1	-6.0	-5.0	-3.5
400MG	0	400	mbar	1800	–	3000	–	–	-8.5	8.5	11.7	17.4	23.2	-1.3	-0.4	1.3	-6.0	-5.0	-3.5
600MG	0	600	mbar	2000	–	4000	–	–	-7.0	7.0	6.0	9.0	12.0	-2.5	-1.0	2.5	-6.0	-5.0	-3.5
001BG	0	1	bar	2	–	4	–	–	-7.0	7.0	10.0	15.0	20.0	-1.5	-0.5	1.5	-6.0	-5.0	-3.5
1.6BG	0	1.6	bar	4	–	8	–	–	-7.0	7.0	12.0	16.0	20.0	-1.5	-0.5	1.5	-6.0	-5.0	-3.5
2.5BG	0	2.5	bar	4	–	8	–	–	-7.0	7.0	18.8	25.0	31.3	-1.0	-0.3	1.0	-6.0	-5.0	-3.5
004BG	0	4	bar	8	–	16	–	–	-7.0	7.0	16.8	20.0	23.2	-1.0	-0.3	1.0	-6.0	-5.0	-3.5
006BG	0	6	bar	16	–	20	–	–	-7.0	7.0	12.6	15.0	17.4	-1.5	-0.4	1.5	-6.0	-5.0	-3.5
010BG	0	10	bar	16	–	20	–	–	-7.0	7.0	21.0	25.0	29.0	-1.0	-0.3	1.0	-6.0	-5.0	-3.5
DIFFERENTIAL																			
060MD	-60	60	mbar	850	850	1400	1400	10000	-8.5	8.5	7.8	11.4	14.8	-1.8	-0.6	1.8	-6.0	-5.0	-3.5
100MD	-100	100	mbar	850	850	1400	1400	10000	-8.5	8.5	13.2	18.8	24.6	-1.1	-0.4	1.1	-6.0	-5.0	-3.5
160MD	-160	160	mbar	850	850	1400	1400	10000	-8.5	8.5	21.0	30.2	39.4	-0.7	-0.2	0.7	-6.0	-5.0	-3.5
250MD	-250	250	mbar	1800	1800	3000	3000	10000	-8.5	8.5	14.6	21.8	29.0	-1.1	-0.4	1.1	-6.0	-5.0	-3.5
400MD	-400	400	mbar	1800	1800	3000	3000	10000	-8.5	8.5	23.4	34.8	46.4	-0.7	-0.2	0.7	-6.0	-5.0	-3.5
600MD	-600	600	mbar	2000	2000	4000	4000	10000	-7.0	7.0	12.0	18.0	24.0	-1.3	-0.5	1.3	-6.0	-5.0	-3.5
001BD	-1	1	bar	2	2	4	4	10	-7.0	7.0	20.0	30.0	40.0	-0.8	-0.3	0.8	-6.0	-5.0	-3.5
1.6BD	-1.6	1.6	bar	4	4	8	8	10	-7.0	7.0	24.0	32.0	40.0	-0.8	-0.3	0.8	-6.0	-5.0	-3.5
2.5BD	-2.5	2.5	bar	4	4	8	8	10	-7.0	7.0	37.6	50.0	62.6	-0.5	-0.2	0.5	-6.0	-5.0	-3.5
004BD	-4	4	bar	8	8	16	16	15	-7.0	7.0	33.6	40.0	46.4	-0.5	-0.2	0.5	-6.0	-5.0	-3.5

¹**Overpressure:** The maximum pressure which may safely be applied to the product for it to remain within specifications once pressure is returned to the operating pressure range. Exposure to higher pressures may cause permanent damage to the product. Unless otherwise specified, this applies to all available pressure ports at any temperature within the operating temperature range.

²**Burst pressure:** The maximum pressure that may be applied to the specified port (P1 or P2) of the product without causing escape of pressure media. Product should not be expected to function after exposure to any pressure beyond the burst pressure.

³**Common mode pressure:** The maximum pressure that can be applied simultaneously to both ports of a differential pressure sensor without causing changes in specified performance.

⁴**Offset:** The output signal obtained when the reference pressure is applied to all available pressure ports. Also known as “null” or “zero”.

⁵**TCO (Thermal Effect on Offset):** The deviation in offset due to changes in temperature over the specified temperature range, relative to offset measured at 25°C.

⁶**TCS (Thermal Effect on Span):** The deviation in full scale span due to changes in temperature over the specified temperature range, relative to full scale span measured at 25°C.

TBP SERIES AND NBP SERIES

BASIC BOARD MOUNT PRESSURE SENSORS

Issue H
50076346

TABLE 9. NBP SERIES PRESSURE RANGE SPECIFICATIONS FOR 1 PSI TO 150 PSI

Pressure Range (see Figure 2)	Pressure Range		Unit	Over-Pressure ¹		Burst Pressure ²		Common Mode Pressure ³	Offset ⁴ (mV/V)		Sensitivity (mV/V/Full Scale Span)			Thermal Effect on Offset (%FSS/25°C) ⁵			Thermal Effect on Span (%FSS/25°C) ⁶		
	Pmin.	Pmax.		Port 1	Port 2	Port 1	Port 2		Min.	Max.	Min.	Nom.	Max.	Min.	Nom.	Max.	Min.	Nom.	Max.
ABSOLUTE																			
015PA	0	15	psi	30	–	60	–	–	-7.0	7.0	10.3	15.0	20.7	-1.5	-0.6	1.5	-6.0	-5.0	-3.5
030PA	0	30	psi	60	–	120	–	–	-7.0	7.0	15.5	21.0	26.0	-1.0	-0.4	1.0	-6.0	-5.0	-3.5
060PA	0	60	psi	120	–	240	–	–	-7.0	7.0	17.4	21.0	24.0	-1.0	-0.3	1.0	-6.0	-5.0	-3.5
100PA	0	100	psi	240	–	300	–	–	-7.0	7.0	14.5	17.2	20.0	-1.0	-0.4	1.0	-6.0	-5.0	-3.5
150PA	0	150	psi	240	–	300	–	–	-7.0	7.0	21.7	26.0	30.0	-1.0	-0.3	1.0	-6.0	-5.0	-3.5
GAGE																			
001PG	0	1	psi	10	–	20	–	–	-8.5	8.5	4.5	6.5	8.5	-3.0	-1.0	3.0	-6.0	-5.0	-3.5
005PG	0	5	psi	30	–	40	–	–	-8.5	8.5	10.0	15.0	20.0	-1.5	-0.5	1.5	-6.0	-5.0	-3.5
015PG	0	15	psi	30	–	60	–	–	-7.0	7.0	10.3	15.0	20.7	-1.5	-0.6	1.5	-6.0	-5.0	-3.5
030PG	0	30	psi	60	–	120	–	–	-7.0	7.0	15.5	21.0	26.0	-1.0	-0.4	1.0	-6.0	-5.0	-3.5
060PG	0	60	psi	120	–	240	–	–	-7.0	7.0	17.4	21.0	24.0	-1.0	-0.3	1.0	-6.0	-5.0	-3.5
100PG	0	100	psi	240	–	300	–	–	-7.0	7.0	14.5	17.2	20.0	-1.0	-0.4	1.0	-6.0	-5.0	-3.5
150PG	0	150	psi	240	–	300	–	–	-7.0	7.0	21.7	26.0	30.0	-1.0	-0.3	1.0	-6.0	-5.0	-3.5
DIFFERENTIAL																			
001PD	-1	1	psi	10	10	20	20	150	-8.5	8.5	9.0	13.0	17.0	-1.5	-0.5	1.5	-6.0	-5.0	-3.5
005PD	-5	5	psi	30	30	40	40	150	-8.5	8.5	20.0	30.0	40.0	-0.8	-0.3	0.8	-6.0	-5.0	-3.5
015PD	-15	15	psi	30	30	60	60	150	-7.0	7.0	20.6	30.0	41.4	-0.8	-0.3	0.8	-6.0	-5.0	-3.5
030PD	-30	30	psi	60	60	120	120	150	-7.0	7.0	31.0	42.0	52.0	-0.5	-0.2	0.5	-6.0	-5.0	-3.5
060PD	-60	60	psi	120	120	240	240	250	-7.0	7.0	34.8	42.0	48.0	-0.5	-0.2	0.5	-6.0	-5.0	-3.5

¹**Overpressure:** The maximum pressure which may safely be applied to the product for it to remain within specifications once pressure is returned to the operating pressure range. Exposure to higher pressures may cause permanent damage to the product. Unless otherwise specified, this applies to all available pressure ports at any temperature within the operating temperature range.

²**Burst pressure:** The maximum pressure that may be applied to the specified port (P1 or P2) of the product without causing escape of pressure media. Product should not be expected to function after exposure to any pressure beyond the burst pressure.

³**Common mode pressure:** The maximum pressure that can be applied simultaneously to both ports of a differential pressure sensor without causing changes in specified performance.

⁴**Offset:** The output signal obtained when the reference pressure is applied to all available pressure ports. Also known as "null" or "zero".

⁵**TCO (Thermal Effect on Offset):** The deviation in offset due to changes in temperature over the specified temperature range, relative to offset measured at 25°C.

⁶**TCS (Thermal Effect on Span):** The deviation in full scale span due to changes in temperature over the specified temperature range, relative to full scale span.

TBP SERIES AND NBP SERIES BASIC BOARD MOUNT PRESSURE SENSORS

Issue H
50076346

FIGURE 1. DIP PACKAGE DIMENSIONAL DRAWINGS (FOR REFERENCE ONLY: MM [IN].)

AN: Single axial small barbed port

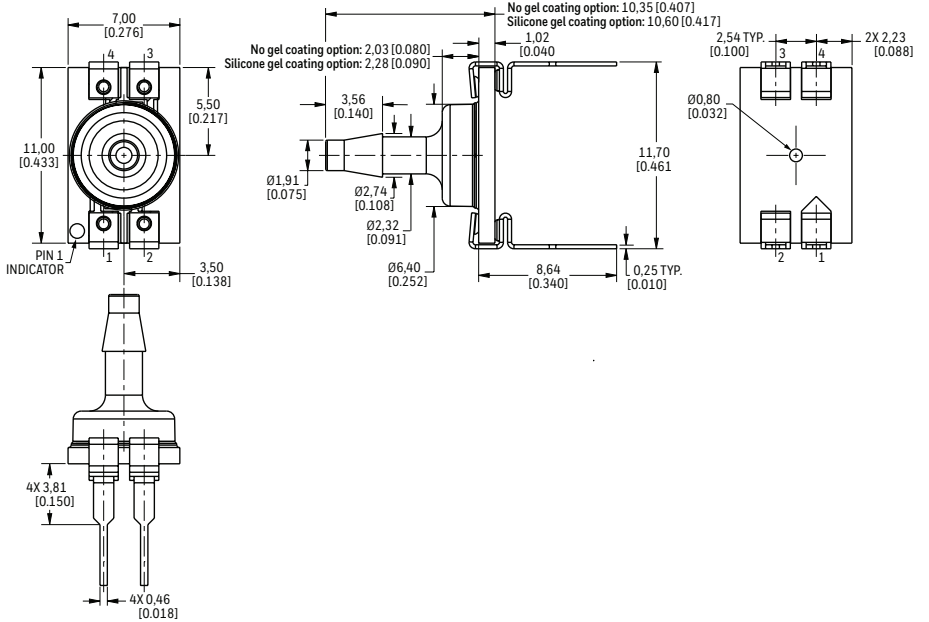
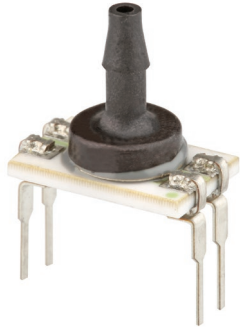

JJ: Dual radial barbless port

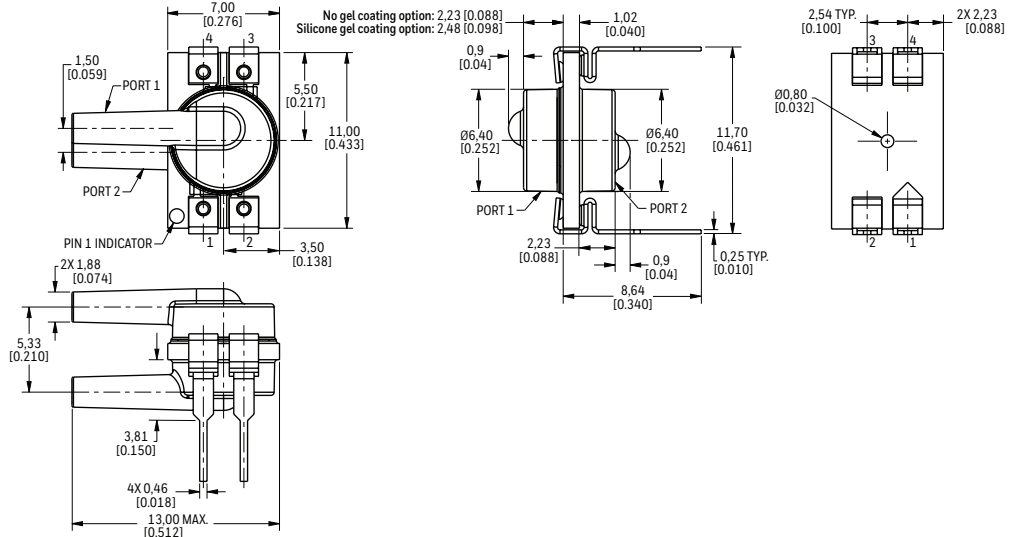
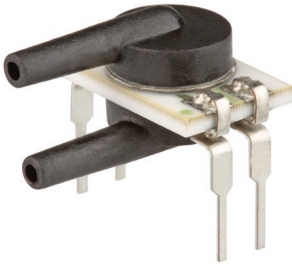

JN: Single radial barbless port

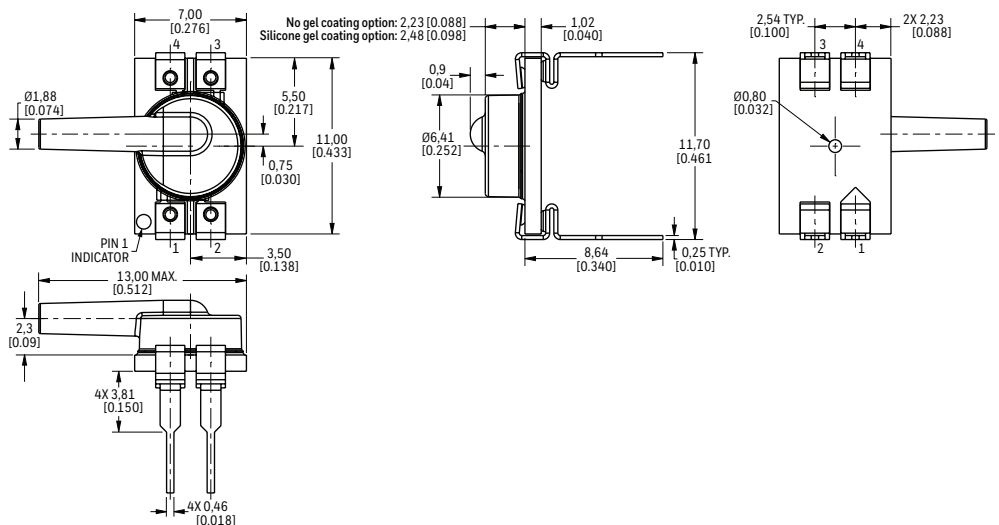
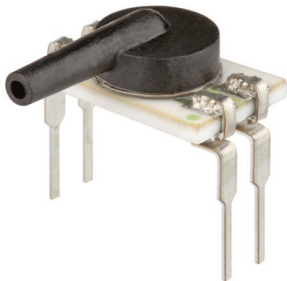

TBP SERIES AND NBP SERIES BASIC BOARD MOUNT PRESSURE SENSORS

Issue H
50076346

FIGURE 1. DIP PACKAGE DIMENSIONAL DRAWINGS (FOR REFERENCE ONLY: MM [IN], CONTINUED.)

KN: Single axial large barbed port

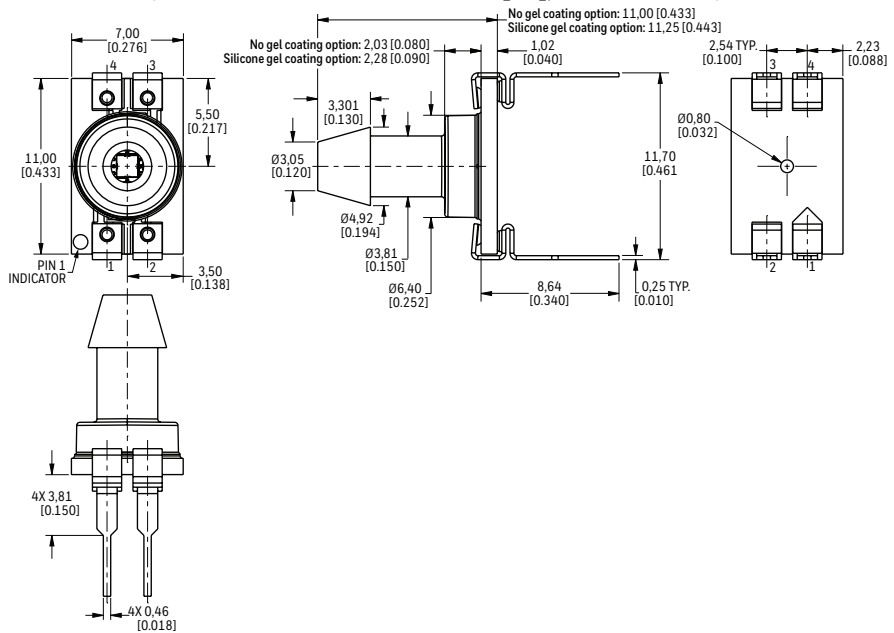
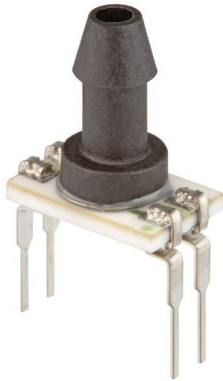

LN: Single axial barbless port

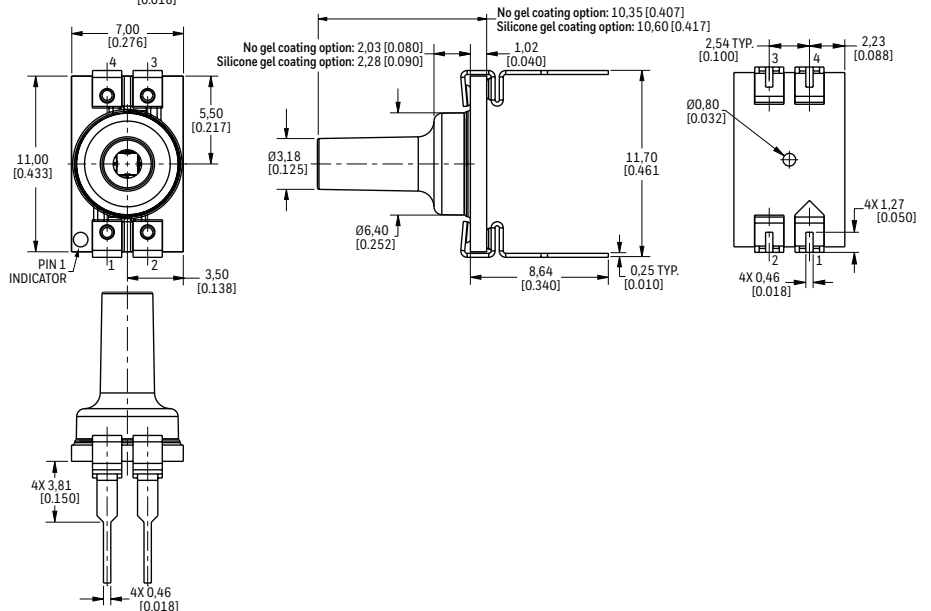
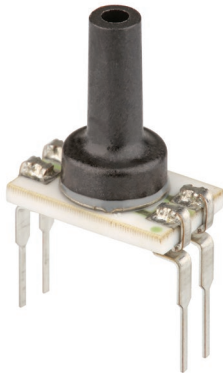

PN: Low-profile port

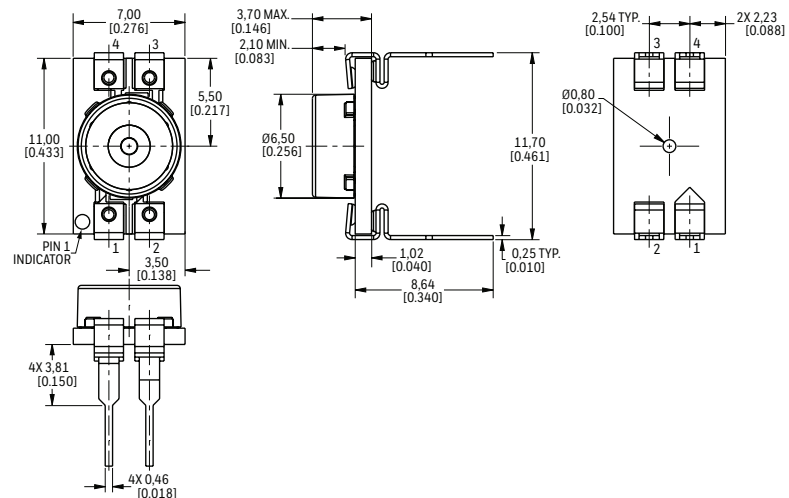
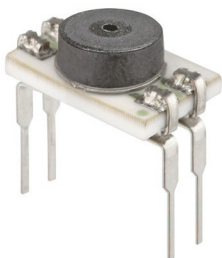

TBP SERIES AND NBP SERIES BASIC BOARD MOUNT PRESSURE SENSORS

Issue H
50076346

FIGURE 1. DIP PACKAGE DIMENSIONAL DRAWINGS (FOR REFERENCE ONLY: MM [IN], CONTINUED.)

RN: Single radial barbed port

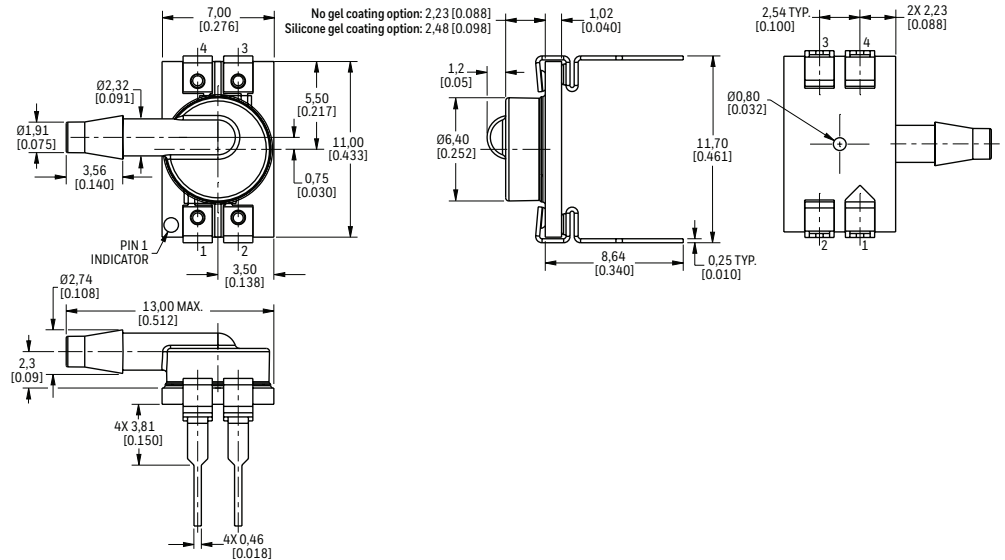
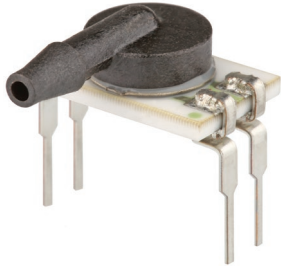

RR: Dual radial barbed port

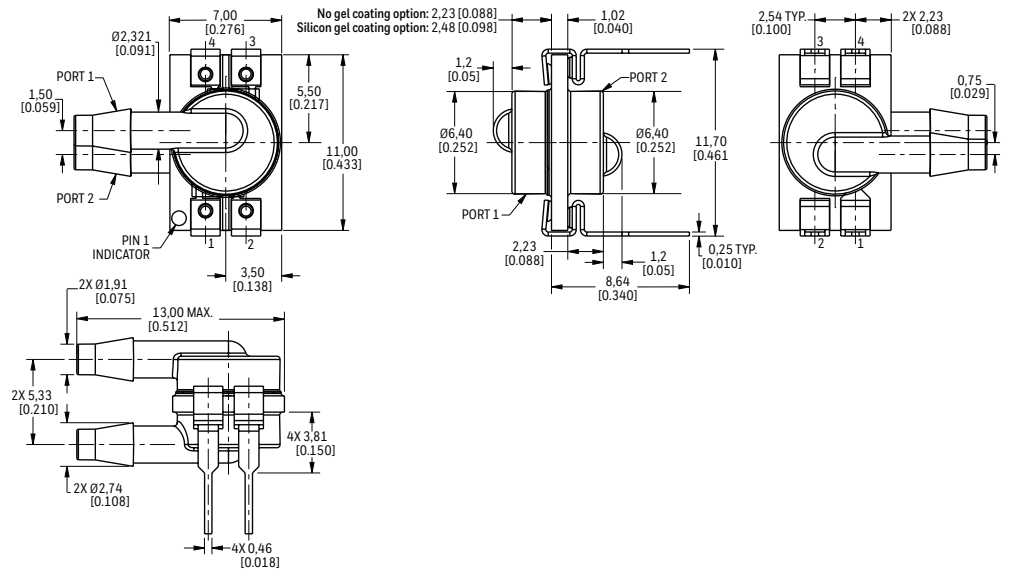
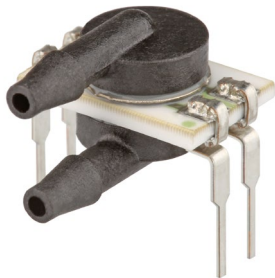

VN: Single axial barbless straight port

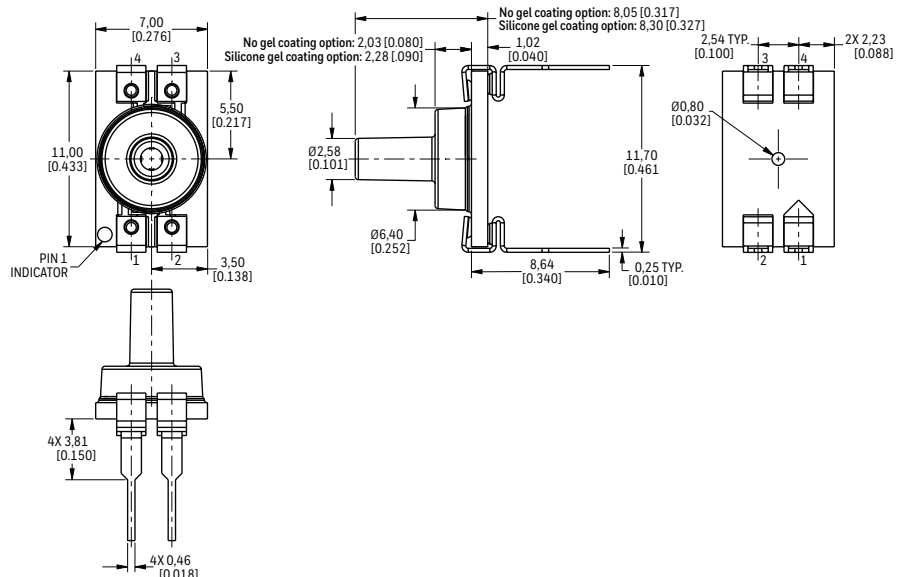
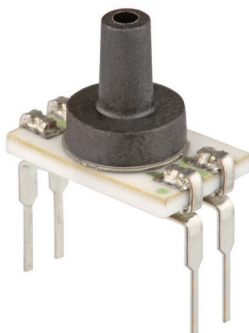

TBP SERIES AND NBP SERIES BASIC BOARD MOUNT PRESSURE SENSORS

Issue H
50076346

FIGURE 1. DIP PACKAGE DIMENSIONAL DRAWINGS (FOR REFERENCE ONLY: MM [IN], CONTINUED.)

Recommended DIP Package PCB Pad Layout

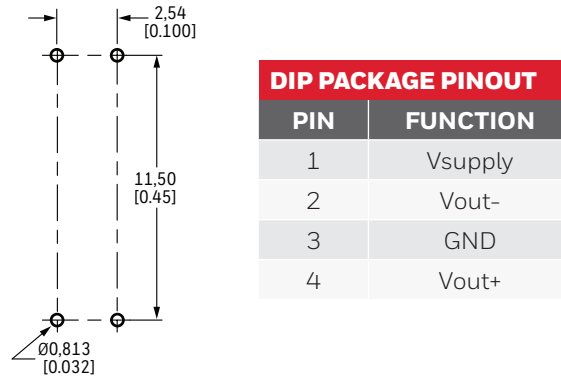
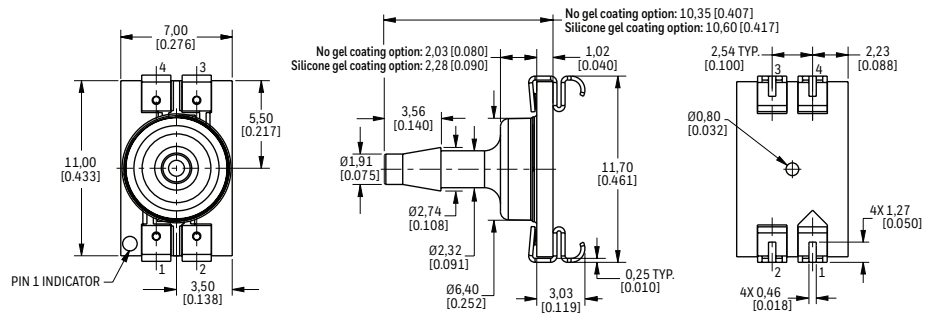
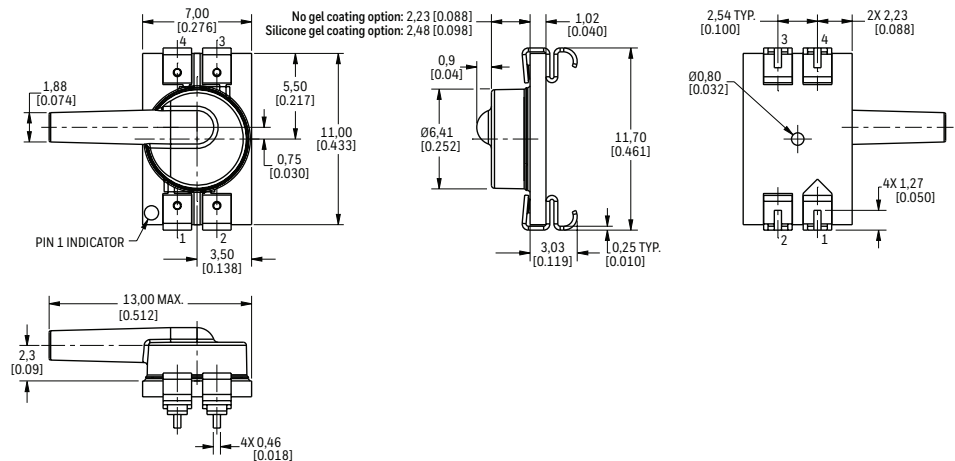

FIGURE 2. SMT PACKAGE DIMENSIONAL DRAWINGS (FOR REFERENCE ONLY: MM [IN].)

AN: Single axial small barbed port



JN: Single radial barbless port



TBP SERIES AND NBP SERIES
BASIC BOARD MOUNT PRESSURE SENSORS

Issue H
 50076346

FIGURE 2. SMT PACKAGE DIMENSIONAL DRAWINGS (FOR REFERENCE ONLY: MM [IN], CONTINUED.)

KN: Single axial large barbed port

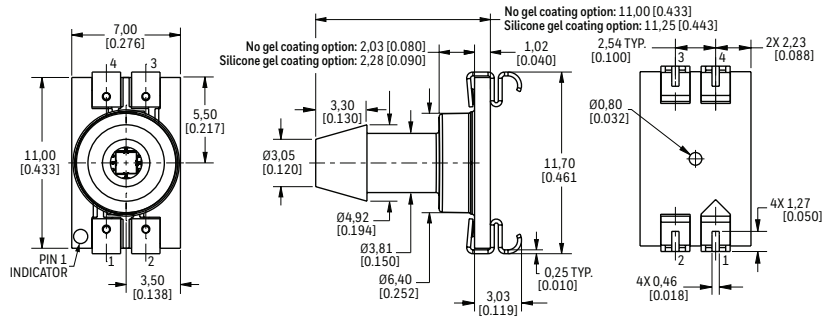

LN: Single axial barbless port

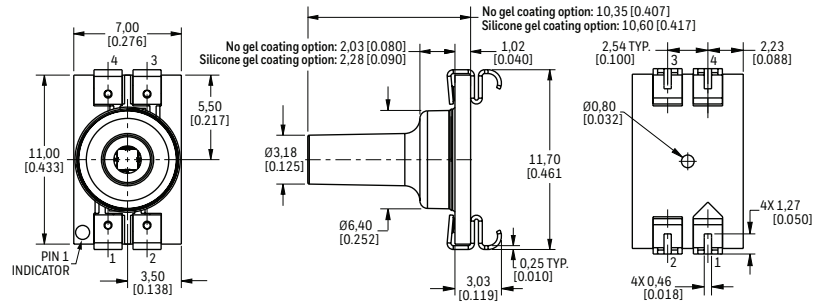
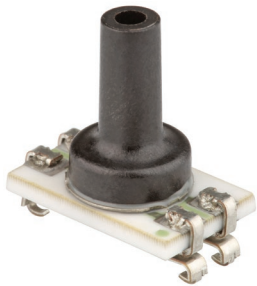

PN: Low-profile port

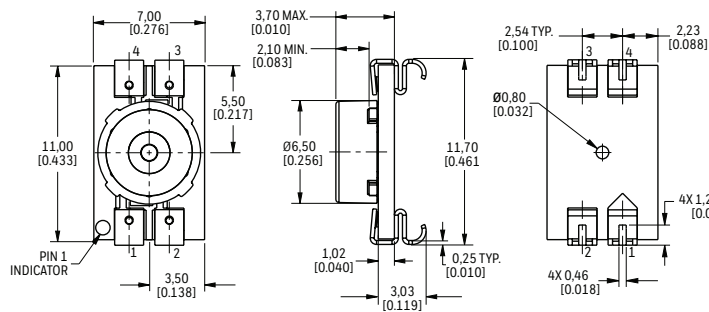
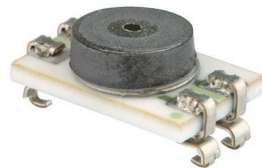

RN: Single radial barbed port

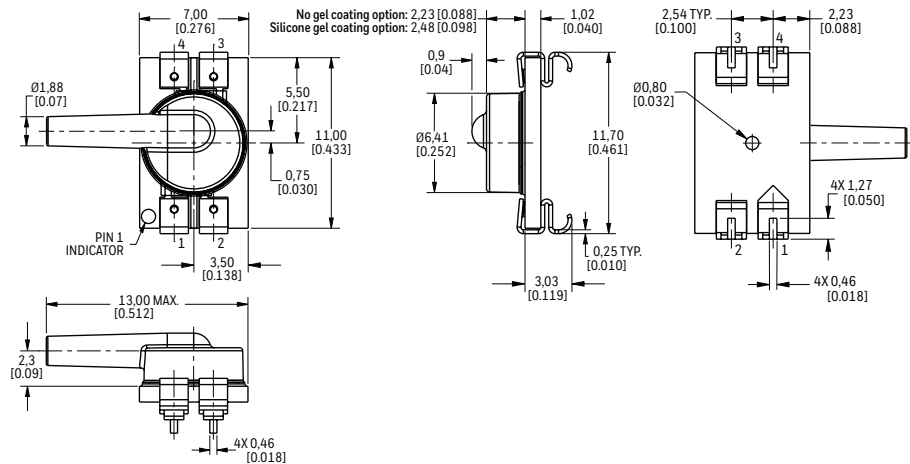
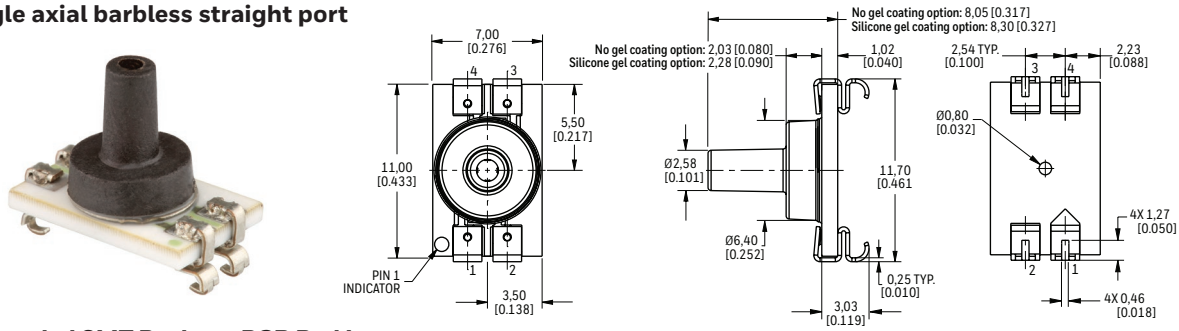
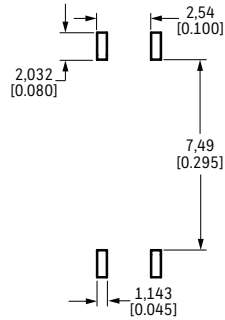

FIGURE 2. SMT PACKAGE DIMENSIONAL DRAWINGS (FOR REFERENCE ONLY: MM [IN], CONTINUED.)

VN: Single axial barbless straight port



Recommended SMT Package PCB Pad Layout



SMT PACKAGE PINOUT	
PIN	FUNCTION
1	Vsupply
2	Vout-
3	GND
4	Vout+

FIGURE 3. LEADLESS SMT PACKAGE DIMENSIONAL DRAWINGS (FOR REFERENCE ONLY: MM [IN].)

AN: Single axial small barbed port

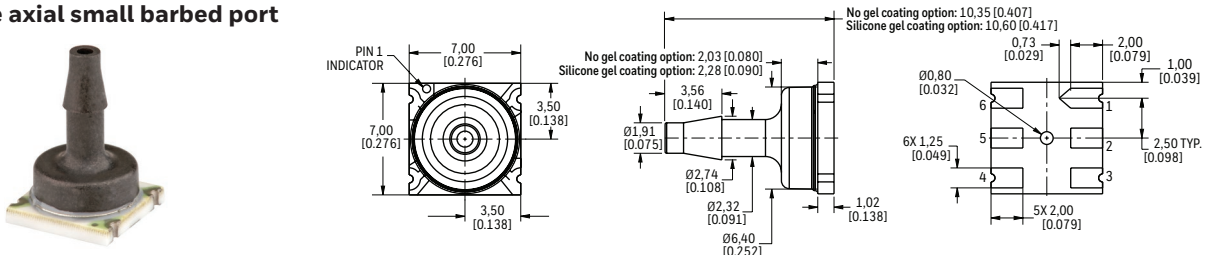

JN: Single radial barbless port

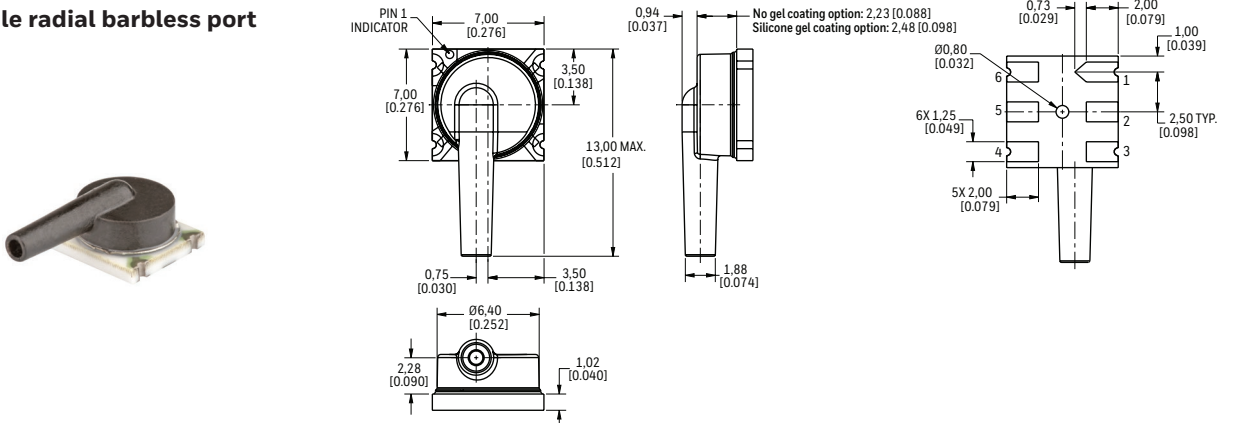

KN: Single axial large barbed port

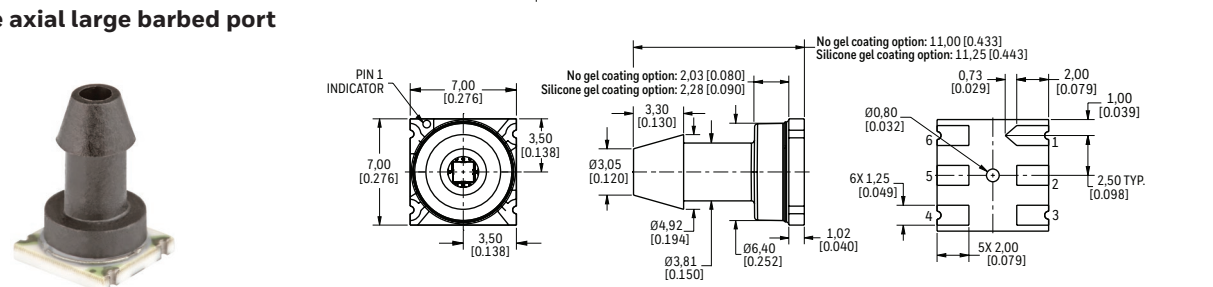
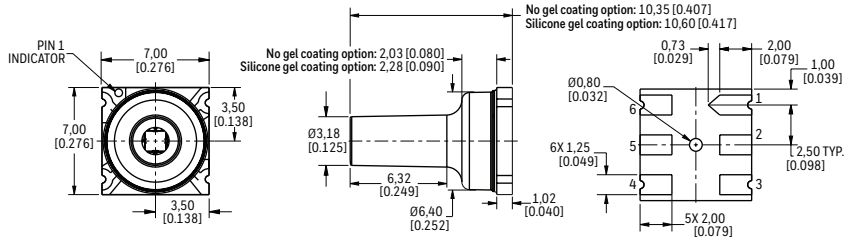
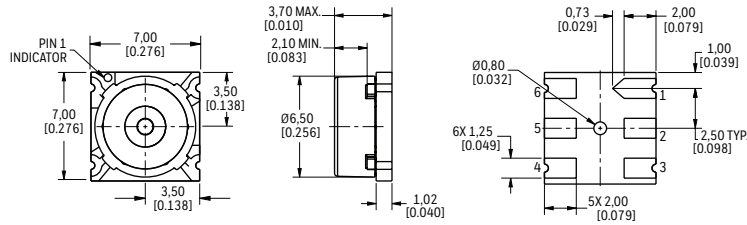
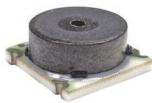

FIGURE 3. LEADLESS SMT PACKAGE DIMENSIONAL DRAWINGS (FOR REFERENCE ONLY: MM [IN], CONTINUED.)

LN: Single axial barbless port



PN: Low-profile port



RN: Single radial barbed port

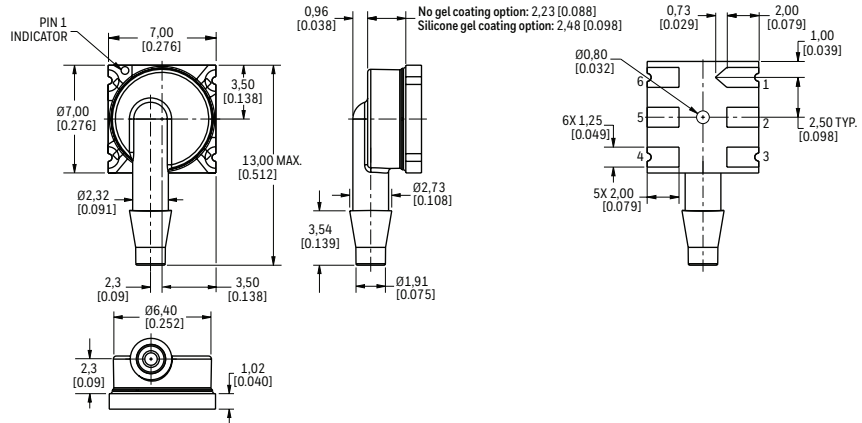

VN: Single axial barbless straight port

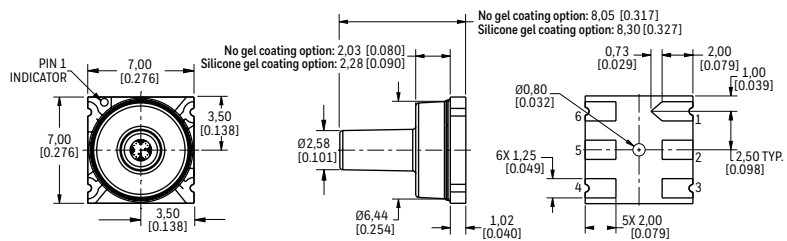

Recommended Leadless SMT PCB Pad Layout

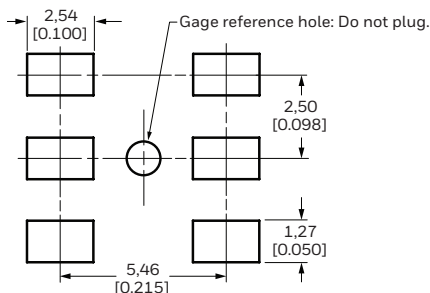

LEADLESS SMT PINOUT

PIN	FUNCTION
1	Vsupply
2	NC
3	Vout-
4	GND
5	NC
6	Vout+

TBP SERIES AND NBP SERIES BASIC BOARD MOUNT PRESSURE SENSORS

Issue H
50076346

WARRANTY/REMEDY

Honeywell warrants goods of its manufacture as being free of defective materials and faulty workmanship during the applicable warranty period. Honeywell's standard product warranty applies unless agreed to otherwise by Honeywell in writing; please refer to your order acknowledgement or consult your local sales office for specific warranty details. If warranted goods are returned to Honeywell during the period of coverage, Honeywell will repair or replace, at its option, without charge those items that Honeywell, in its sole discretion, finds defective.

The foregoing is buyer's sole remedy and is in lieu of all other warranties, expressed or implied, including those of merchantability and fitness for a particular purpose. In no event shall Honeywell be liable for consequential, special, or indirect damages.

While Honeywell may provide application assistance personally, through our literature and the Honeywell web site, it is buyer's sole responsibility to determine the suitability of the product in the application.

Specifications may change without notice. The information we supply is believed to be accurate and reliable as of this writing. However, Honeywell assumes no responsibility for its use.

FOR MORE INFORMATION

Honeywell Advanced Sensing Solutions services its customers through a worldwide network of sales offices and distributors. For application assistance, current specifications, pricing or the nearest Authorized Distributor, visit our [website](#) or call:

USA/Canada	+1 302 613 4491
Latin America	+1 305 805 8188
Europe	+44 1344 238258
Japan	+81 (0) 3-6730-7152
Singapore	+65 6355 2828
Greater China	+86 4006396841

Honeywell Advanced Sensing Technology

830 East Arapaho Road
Richardson, TX 75081
sps.honeywell.com/ast

⚠ WARNING RISK TO LIFE OR PROPERTY

Never use this product for an application involving serious risk to life or property without ensuring that the system as a whole has been designed to address the risks, and that this product is properly rated and installed for the intended use within the overall system.

Failure to comply with these instructions could result in death or serious injury.