

16-BIT, 1.25 MSPS, UNIPOLAR DIFFERENTIAL INPUT, MICRO POWER SAMPLING ANALOG-TO-DIGITAL CONVERTER WITH PARALLEL INTERFACE AND REFERENCE

FEATURES

- 1.25-MHz Sample Rate
- 16-Bit NMC Ensured Over Temperature
- Zero Latency
- Unipolar Differential Input Range: V_{ref} to $-V_{ref}$
- Onboard Reference
- Onboard Reference Buffer
- High-Speed Parallel Interface
- Power Dissipation: 155 mW at 1.25 MHz Typ
- Wide Digital Supply
- 8-/16-Bit Bus Transfer
- 48-Pin TQFP Package

APPLICATIONS

- DWDM
- Instrumentation
- High-Speed, High-Resolution, Zero Latency Data Acquisition Systems
- Transducer Interface
- Medical Instruments
- Communication

DESCRIPTION

The ADS8402 is a 16-bit, 1.25 MHz A/D converter with an internal 4.096-V reference. The device includes a 16-bit capacitor-based SAR A/D converter with inherent sample and hold. The ADS8402 offers a full 16-bit interface and an 8-bit option where data is read using two 8-bit read cycles.

The ADS8402 has a unipolar differential input. It is available in a 48-lead TQFP package and is characterized over the industrial -40°C to 85°C temperature range.

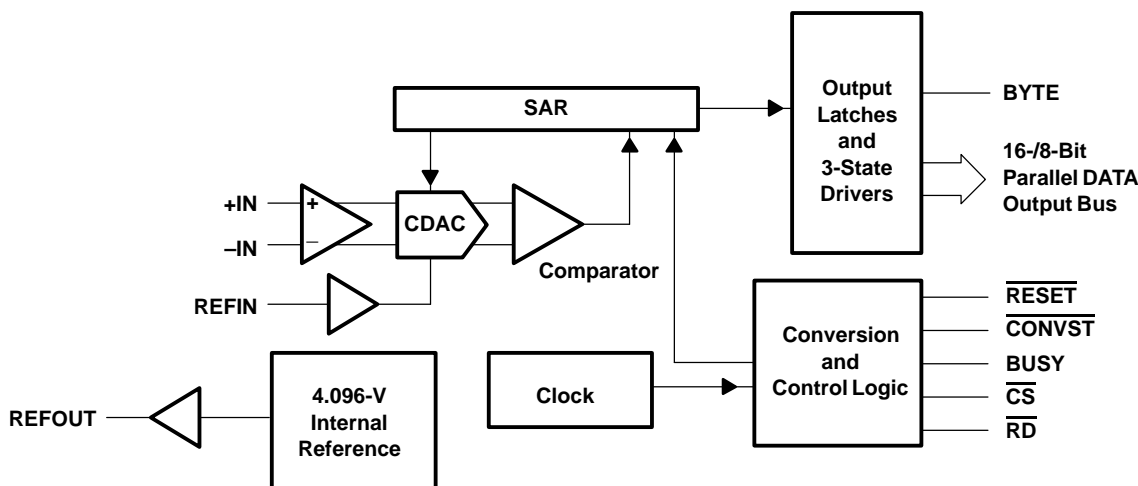

Please be aware that an important notice concerning availability, standard warranty, and use in critical applications of Texas Instruments semiconductor products and disclaimers thereto appears at the end of this data sheet.



These devices have limited built-in ESD protection. The leads should be shorted together or the device placed in conductive foam during storage or handling to prevent electrostatic damage to the MOS gates.

ORDERING INFORMATION

MODEL	MAXIMUM INTEGRAL LINEARITY (LSB)	MAXIMUM DIFFERENTIAL LINEARITY (LSB)	NO MISSING CODES RESOLUTION (BIT)	PACKAGE TYPE	PACKAGE DESIGNATOR	TEMPERATURE RANGE	ORDERING INFORMATION	TRANSPORT MEDIA QUANTITY
ADS8402I	±6	-2~+3	15	48 Pin TQFP	PFB	-40°C to 85°C	ADS8402IPFBT	Tape and reel 250
							ADS8402IPFBR	Tape and reel 1000
ADS8402IB	±3.5	-1~+2	16	48 Pin TQFP	PFB	-40°C to 85°C	ADS8402IBPFBT	Tape and reel 250
							ADS8402IBPFBR	Tape and reel 1000

NOTE: For the most current specifications and package information, refer to our website at www.ti.com.

ABSOLUTE MAXIMUM RATINGS

over operating free-air temperature range unless otherwise noted⁽¹⁾

		UNIT
Voltage	+IN to AGND	+VA + 0.1 V
	-IN to AGND	+VA + 0.1 V
Voltage range	+VA to AGND	-0.3 V to 7 V
	+VBD to BDGND	-0.3 V to 7 V
	+VA to +VBD	-0.3 V to 2.5 V
Digital input voltage to BDGND		-0.3 V to +VBD + 0.3 V
Digital output voltage to BDGND		-0.3 V to +VBD + 0.3 V
Operating free-air temperature range, T _A		-40°C to 85°C
Storage temperature range, T _{stg}		-65°C to 150°C
Junction temperature (T _J max)		150°C
TQFP package	Power dissipation	(T _J Max - T _A)/θ _{JA}
	θ _{JA} thermal impedance	86°C/W
Lead temperature, soldering	Vapor phase (60 sec)	215°C
	Infrared (15 sec)	220°C

(1) Stresses beyond those listed under "absolute maximum ratings" may cause permanent damage to the device. These are stress ratings only, and functional operation of the device at these or any other conditions beyond those indicated under "recommended operating conditions" is not implied. Exposure to absolute-maximum-rated conditions for extended periods may affect device reliability.

SPECIFICATIONS
 $T_A = -40^\circ\text{C}$ to 85°C , $+VA = 5\text{ V}$, $+VBD = 3\text{ V}$ or 5 V , $V_{\text{ref}} = 4.096\text{ V}$, $f_{\text{SAMPLE}} = 1.25\text{ MHz}$ (unless otherwise noted)

PARAMETER		TEST CONDITIONS	MIN	TYP	MAX	UNIT
Analog Input						
Full-scale input voltage (see Note 1)		+IN – –IN	$-V_{\text{ref}}$		V_{ref}	V
Absolute input voltage		+IN	-0.2		$V_{\text{ref}} + 0.2$	V
		-IN	-0.2		$V_{\text{ref}} + 0.2$	
Common-mode input range	ADS8402I		$(V_{\text{ref}}/2) - 0.2$	$V_{\text{ref}}/2$	$(V_{\text{ref}}/2) + 0.2$	V
Input capacitance				25		pF
Input leakage current				0.5		nA
System Performance						
Resolution				16		Bits
No missing codes	ADS8402I		15			Bits
	ADS8402IB		16			
Integral linearity (see Notes 2 and 3)	ADS8402I		-6	± 2.5	6	LSB
	ADS8402IB		-3.5	± 2	3.5	
Differential linearity	ADS8402I		-2	± 1	3	LSB
	ADS8402IB		-1	± 0.75	2	
Offset error (see Note 4)	ADS8402I		-3	± 1	3	mV
	ADS8402IB		-1.5	± 0.5	1.5	mV
Gain error (see Notes 4 and 5)	ADS8402I		-0.15		0.15	%FS
	ADS8402IB		-0.098		0.098	
Common-mode rejection ratio	At dc ($\pm 0.2\text{ V}$ around $V_{\text{ref}}/2$)			80		dB
	+IN – –IN = 1 V_{pp} at 1 MHz			80		
Noise				60		$\mu\text{V RMS}$
DC Power supply rejection ratio		At 7FFFh output code, $+VA = 4.75\text{ V}$ to 5.25 V , $V_{\text{ref}} = 4.096\text{ V}$, See Note 4		1		LSB
Sampling Dynamics						
Conversion time					610	ns
Acquisition time			150			ns
Throughput rate					1.25	MHz
Aperture delay				2		ns
Aperture jitter				25		ps
Step response				100		ns
Overvoltage recovery				100		ns

(1) Ideal input span, does not include gain or offset error.

(2) LSB means least significant bit

(3) This is endpoint INL, not best fit

(4) Measured relative to an ideal full-scale input (+IN – –IN) of 8.192 V

(5) This specification does not include the internal reference voltage error and drift.

SPECIFICATIONS (CONTINUED)

T_A = -40°C to 85°C, +VA = +5 V, +VBD = 3 V or 5 V, V_{ref} = 4.096 V, f_{SAMPLE} = 1.25 MHz (unless otherwise noted)

PARAMETER		TEST CONDITIONS	MIN	TYP	MAX	UNIT
Dynamic Characteristics						
Total harmonic distortion (THD) (see Note 1)		V _{IN} = 8 V _{pp} at 100 kHz		-95		dB
Signal-to-noise ratio (SNR)		V _{IN} = 8 V _{pp} at 100 kHz		90		dB
Signal-to-noise + distortion (SINAD)		V _{IN} = 8 V _{pp} at 100 kHz		88		dB
Spurious free dynamic range (SFDR)		V _{IN} = 8 V _{pp} at 100 kHz		95		dB
-3dB Small signal bandwidth				5		MHz
External Voltage Reference Input						
Reference voltage at REFIN, V _{ref}			2.5	4.096	4.2	V
Reference resistance (see Note 2)				500		kΩ
Internal Reference Output						
Internal reference start-up time		From 95% (+VA), with 1 μF storage capacity			120	ms
V _{ref} range		I _{OUT} = 0	4.065	4.096	4.13	V
Source Current		Static load			10	μA
Line Regulation		+VA = 4.75 ~ 5.25 V		0.6		mV
Drift		I _{OUT} = 0		36		PPM/C
Digital Input/Output						
Logic family				CMOS		
Logic level	V _{IH}	I _{IH} = 5 μA	+VBD-1		+VBD + 0.3	V
	V _{IL}	I _{IL} = 5 μA	-0.3		0.8	
	V _{OH}	I _{OH} = 2 TTL loads	+VBD - 0.6		+VBD	
	V _{OL}	I _{OL} = 2 TTL loads	0		0.4	
Data format				2's Complement		
Power Supply Requirements						
Power supply voltage	+VBD (see Notes 3 and 4)		2.95	3.3	5.25	V
	+VA (see Note 4)		4.75	5	5.25	V
+VA Supply current (see Note 5)		f _S = 1.25 MHz		31	34	mA
Power dissipation (see Note 5)		f _S = 1.25 MHz		155		mW
Temperature Range						
Operating free-air			-40		85	°C

(1) Calculated on the first nine harmonics of the input frequency

(2) Can vary ±20%

(3) The difference between +VA and +VBD should not be less than 2.3 V, i.e., if +VA is 5.25 V, +VBD should be minimum of 2.95 V.

(4) +VBD ≥ +VA - 2.3 V

(5) This includes only VA+ current. +VBD current is typically 1 mA with 5 pF load capacitance on output pins.

TIMING CHARACTERISTICS

 All specifications typical at -40°C to 85°C , $+V_A = +V_{BD} = 5\text{ V}$ (see Notes 1, 2, and 3)

PARAMETER		MIN	TYP	MAX	UNIT
t_{CONV}	Conversion time		600	610	ns
t_{ACQ}	Acquisition time	150			ns
t_{pd1}	$\overline{\text{CONVST}}$ low to conversion started (BUSY high)			35	ns
t_{pd2}	Propagation delay time, End of conversion to BUSY low			20	ns
t_{w1}	Pulse duration, $\overline{\text{CONVST}}$ low	20			ns
t_{su1}	Setup time, $\overline{\text{CS}}$ low to $\overline{\text{CONVST}}$ low	0			ns
t_{w2}	Pulse duration, $\overline{\text{CONVST}}$ high	20			ns
	$\overline{\text{CONVST}}$ falling edge jitter			10	ps
t_{w3}	Pulse duration, BUSY signal low	$\text{Min}(t_{\text{ACQ}})$			ns
t_{w4}	Pulse duration, BUSY signal high			630	ns
t_{h1}	Hold time, First data bus data transition ($\overline{\text{RD}}$ low, or $\overline{\text{CS}}$ low for read cycle, or BYTE input changes) after $\overline{\text{CONVST}}$ low	40			ns
t_{d1}	Delay time, $\overline{\text{CS}}$ low to $\overline{\text{RD}}$ low	0			ns
t_{su2}	Setup time, $\overline{\text{RD}}$ high to $\overline{\text{CS}}$ high	0			ns
t_{w5}	Pulse duration, $\overline{\text{RD}}$ low time	50			ns
t_{en}	Enable time, $\overline{\text{RD}}$ low (or $\overline{\text{CS}}$ low for read cycle) to data valid			20	ns
t_{d2}	Delay time, data hold from $\overline{\text{RD}}$ high	0			ns
t_{d3}	Delay time, BYTE rising edge or falling edge to data valid	2		20	ns
t_{w6}	$\overline{\text{RD}}$ high	20			ns
t_{h2}	Hold time, last $\overline{\text{RD}}$ (or $\overline{\text{CS}}$ for read cycle) rising edge to $\overline{\text{CONVST}}$ falling edge	50			ns
t_{pd4}	Propagation delay time, BUSY falling edge to next $\overline{\text{RD}}$ (or $\overline{\text{CS}}$ for read cycle) falling edge	$\text{Max}(t_{\text{d5}})$			ns
t_{su3}	Setup time, BYTE rising edge to $\overline{\text{RD}}$ falling edge	0			ns
t_{h3}	Hold time, BYTE falling edge to $\overline{\text{RD}}$ falling edge	0			ns
t_{dis}	Disable time, $\overline{\text{RD}}$ High ($\overline{\text{CS}}$ high for read cycle) to 3-stated data bus			20	ns
t_{d5}	Delay time, BUSY low to MSB data valid			0	ns

 (1) All input signals are specified with $t_r = t_f = 5\text{ ns}$ (10% to 90% of $+V_{BD}$) and timed from a voltage level of $(V_{\text{IL}} + V_{\text{IH}})/2$.

(2) See timing diagrams.

(3) All timings are measured with 20 pF equivalent loads on all data bits and BUSY pins.

TIMING CHARACTERISTICS

All specifications typical at -40°C to 85°C, +VA = 5 V, +VBD = 3 V (see Notes 1, 2, and 3)

PARAMETER		MIN	TYP	MAX	UNIT
t _{CONV}	Conversion time		600	610	ns
t _{ACQ}	Acquisition time	150			ns
t _{pd1}	CONVST low to conversion started (BUSY high)			40	ns
t _{pd2}	Propagation delay time, end of conversion to BUSY low			20	ns
t _{w1}	Pulse duration, CONVST low	20			ns
t _{su1}	Setup time, CS low to CONVST low	0			ns
t _{w2}	Pulse duration, CONVST high	20			ns
	CONVST falling edge jitter			10	ps
t _{w3}	Pulse duration, BUSY signal low	Min(t _{ACQ})			ns
t _{w4}	Pulse duration, BUSY signal high			630	ns
t _{h1}	Hold time, first data bus transition (RD low, or CS low for read cycle, or BYTE or BUS 16/16 input changes) after CONVST low	40			ns
t _{d1}	Delay time, CS low to RD low	0			ns
t _{su2}	Setup time, RD high to CS high	0			ns
t _{w5}	Pulse duration, RD low	50			ns
t _{en}	Enable time, RD low (or CS low for read cycle) to data valid			30	ns
t _{d2}	Delay time, data hold from RD high	0			ns
t _{d3}	Delay time, BUS16/16 or BYTE rising edge or falling edge to data valid	2		30	ns
t _{w6}	Pulse duration, RD high time	20			ns
t _{h2}	Hold time, last RD (or CS for read cycle) rising edge to CONVST falling edge	50			ns
t _{pd4}	Propagation delay time, BUSY falling edge to next RD (or CS for read cycle) falling edge	Max(td5)			ns
t _{su3}	Setup time, BYTE rising edge to RD falling edge	0			ns
t _{h3}	Hold time, BYTE falling edge to RD falling edge	0			ns
t _{dis}	Disable time, RD High (CS high for read cycle) to 3-stated data bus			30	ns
t _{d5}	Delay time, BUSY low to MSB data valid delay time			0	ns

(1) All input signals are specified with t_r = t_f = 5 ns (10% to 90% of +VBD) and timed from a voltage level of (V_{IL} + V_{IH})/2.

(2) See timing diagrams.

(3) All timings are measured with 10 pF equivalent loads on all data bits and BUSY pins.

PIN ASSIGNMENTS

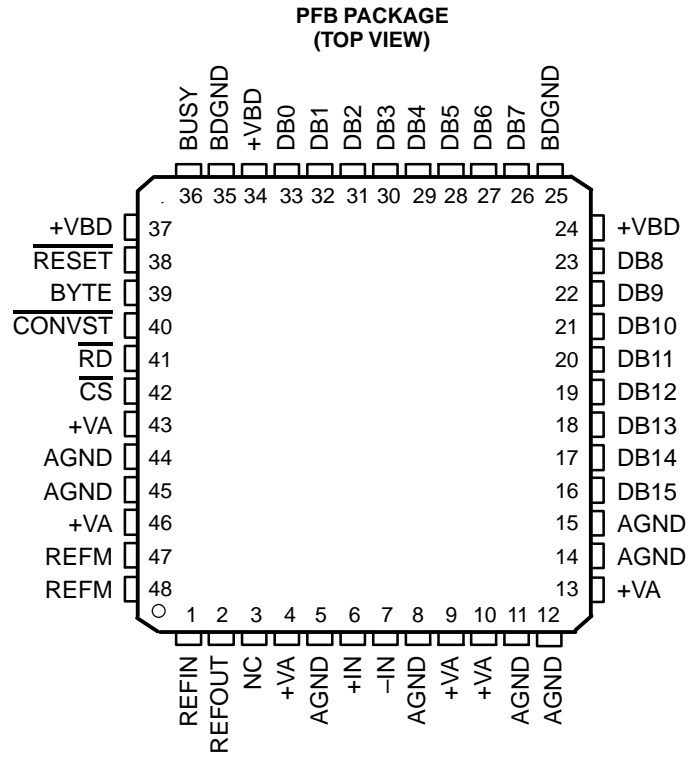

NC – No connection

TERMINAL FUNCTIONS

NAME	NO.	I/O	DESCRIPTION		
AGND	5, 8, 11, 12, 14, 15, 44, 45	–	Analog ground		
BDGND	25, 35	–	Digital ground for bus interface digital supply		
BUSY	36	O	Status output. High when a conversion is in progress.		
BYTE	39	I	Byte select input. Used for 8-bit bus reading. 0: No fold back 1: Low byte D[7:0] of the 16 most significant bits is folded back to high byte of the 16 most significant pins DB[15:8].		
CONVST	40	I	Convert start		
CS	42	I	Chip select		
Data Bus			8-Bit Bus		16-Bit Bus
			BYTE = 0	BYTE = 1	BYTE = 0
DB15	16	O	D15 (MSB)	D7	D15 (MSB)
DB14	17	O	D14	D6	D14
DB13	18	O	D13	D5	D13
DB12	19	O	D12	D4	D12
DB11	20	O	D11	D3	D11
DB10	21	O	D10	D2	D10
DB9	22	O	D9	D1	D9
DB8	23	O	D8	D0 (LSB)	D8
DB7	26	O	D7	All ones	D7
DB6	27	O	D6	All ones	D6
DB5	28	O	D5	All ones	D5
DB4	29	O	D4	All ones	D4
DB3	30	O	D3	All ones	D3
DB2	31	O	D2	All ones	D2
DB1	32	O	D1	All ones	D1
DB0	33	O	D0 (LSB)	All ones	D0 (LSB)
–IN	7	I	Inverting input channel		
+IN	6	I	Non inverting input channel		
NC	3	–	No connection		
REFIN	1	I	Reference input		
REFM	47, 48	I	Reference ground		
REFOUT	2	O	Reference output. Add 1 μ F capacitor between the REFOUT pin and REFM pin when internal reference is used.		
RESET	38	I	Current conversion is aborted and output latches are cleared (set to zeros) when this pin is asserted low. RESET works independantly of CS.		
RD	41	I	Synchronization pulse for the parallel output.		
+VA	4, 9, 10, 13, 43, 46	–	Analog power supplies, 5-V dc		
+VBD	24, 34, 37	–	Digital power supply for bus		

TIMING DIAGRAMS

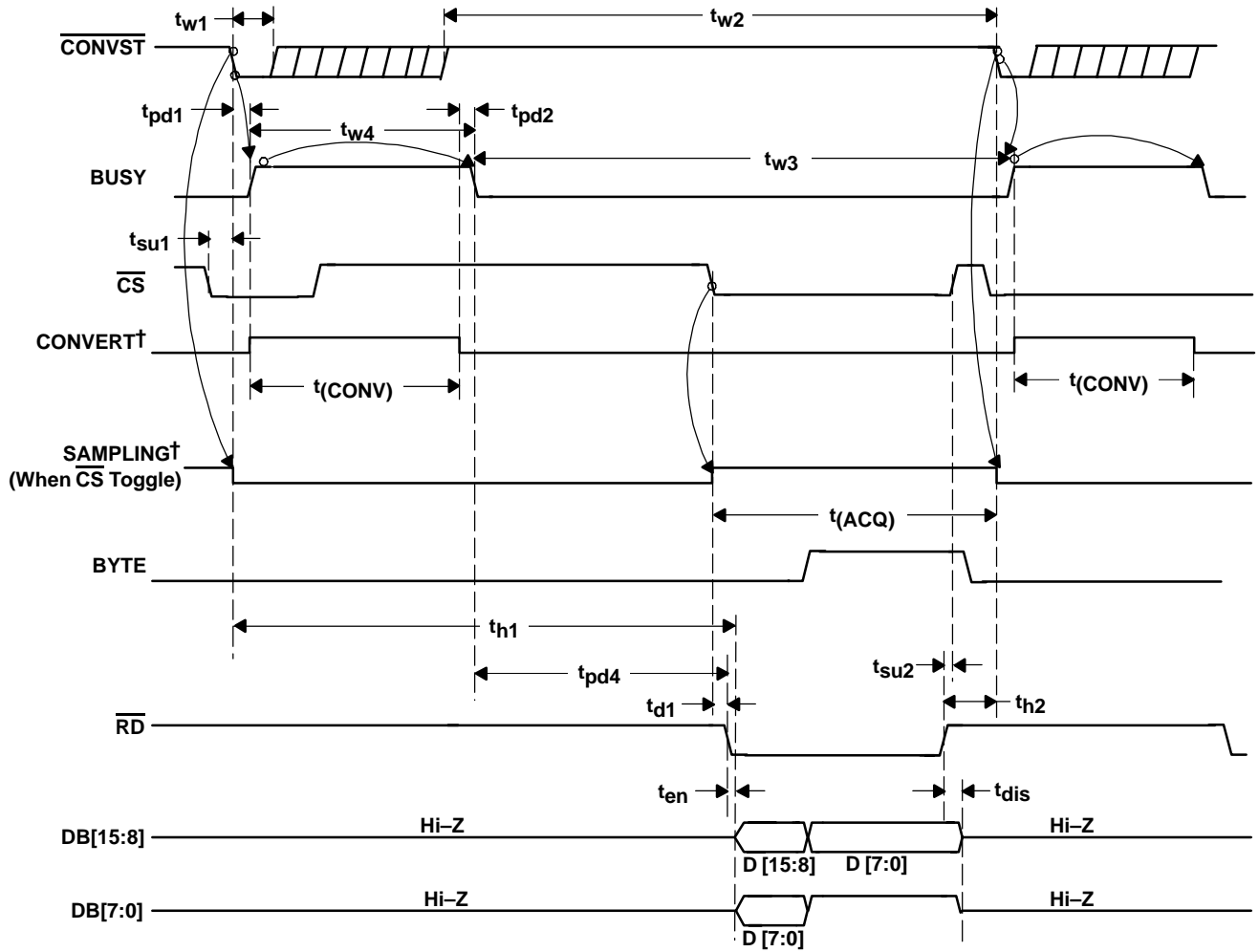

†Signal internal to device

Figure 1. Timing for Conversion and Acquisition Cycles With \overline{CS} and \overline{RD} Toggling

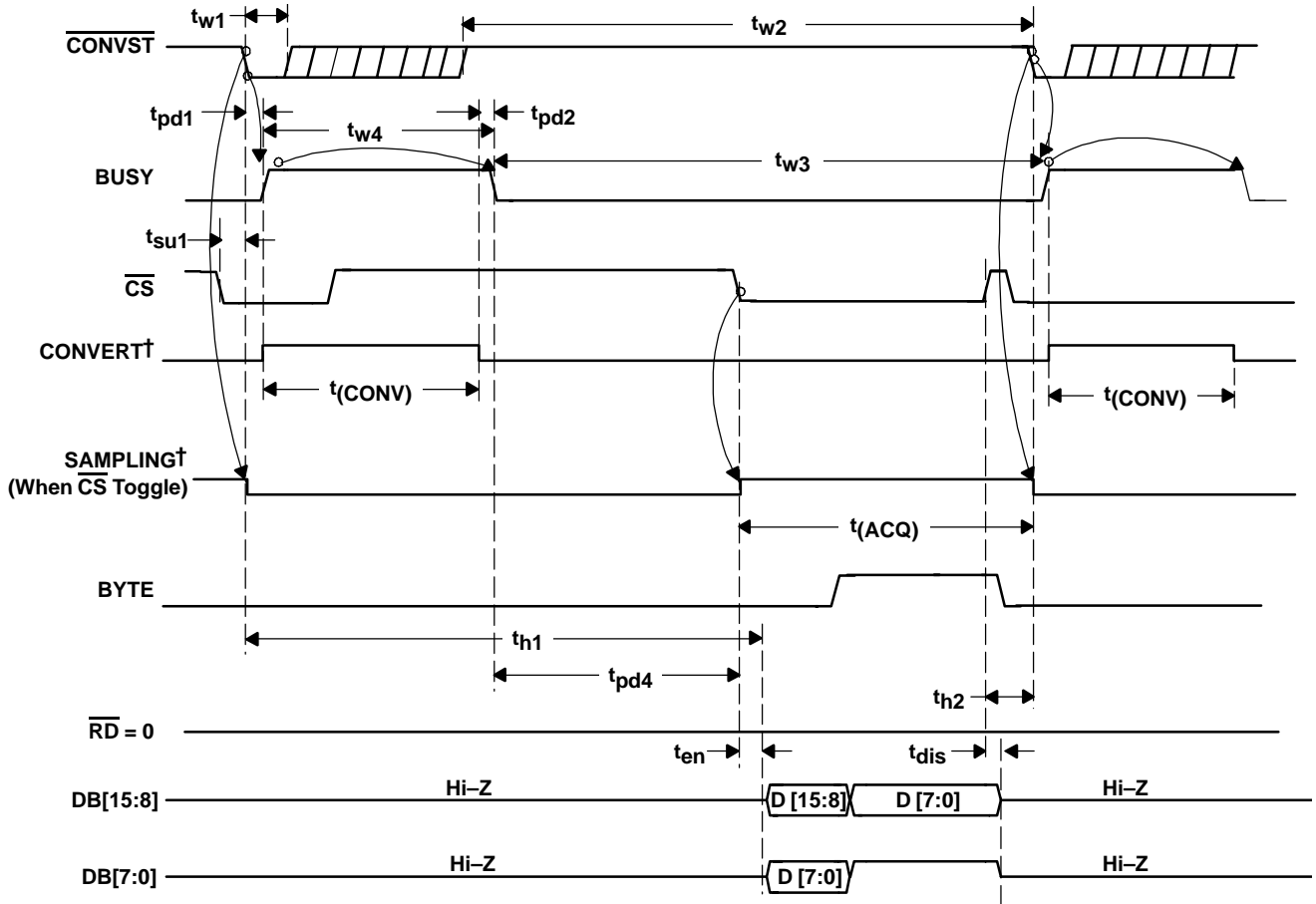

† Signal internal to device

Figure 2. Timing for Conversion and Acquisition Cycles With $\overline{\text{CS}}$ Toggling, $\overline{\text{RD}}$ Tied to BDGND

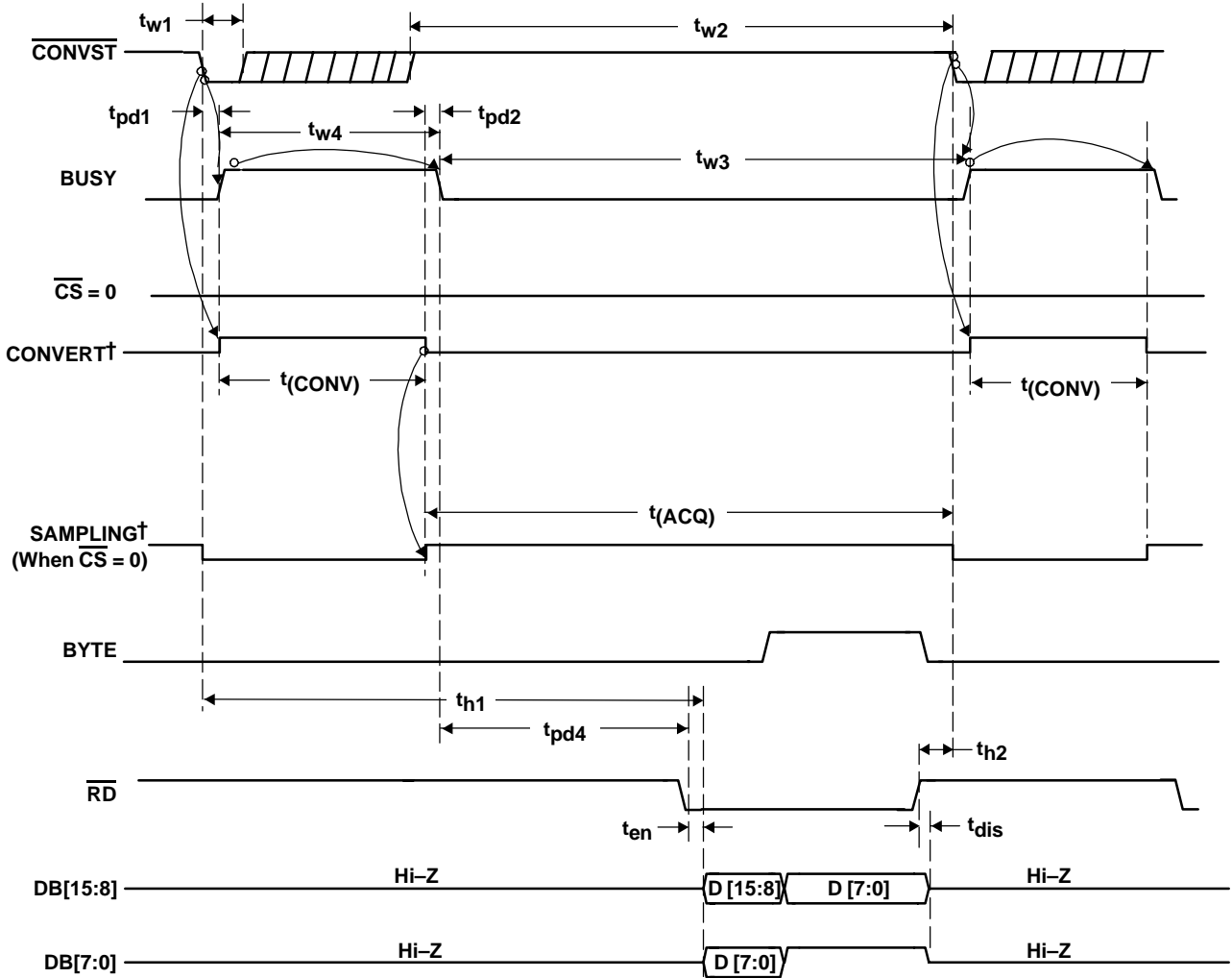

†Signal internal to device

Figure 3. Timing for Conversion and Acquisition Cycles With $\overline{\text{CS}}$ Tied to BDGND, $\overline{\text{RD}}$ Toggling

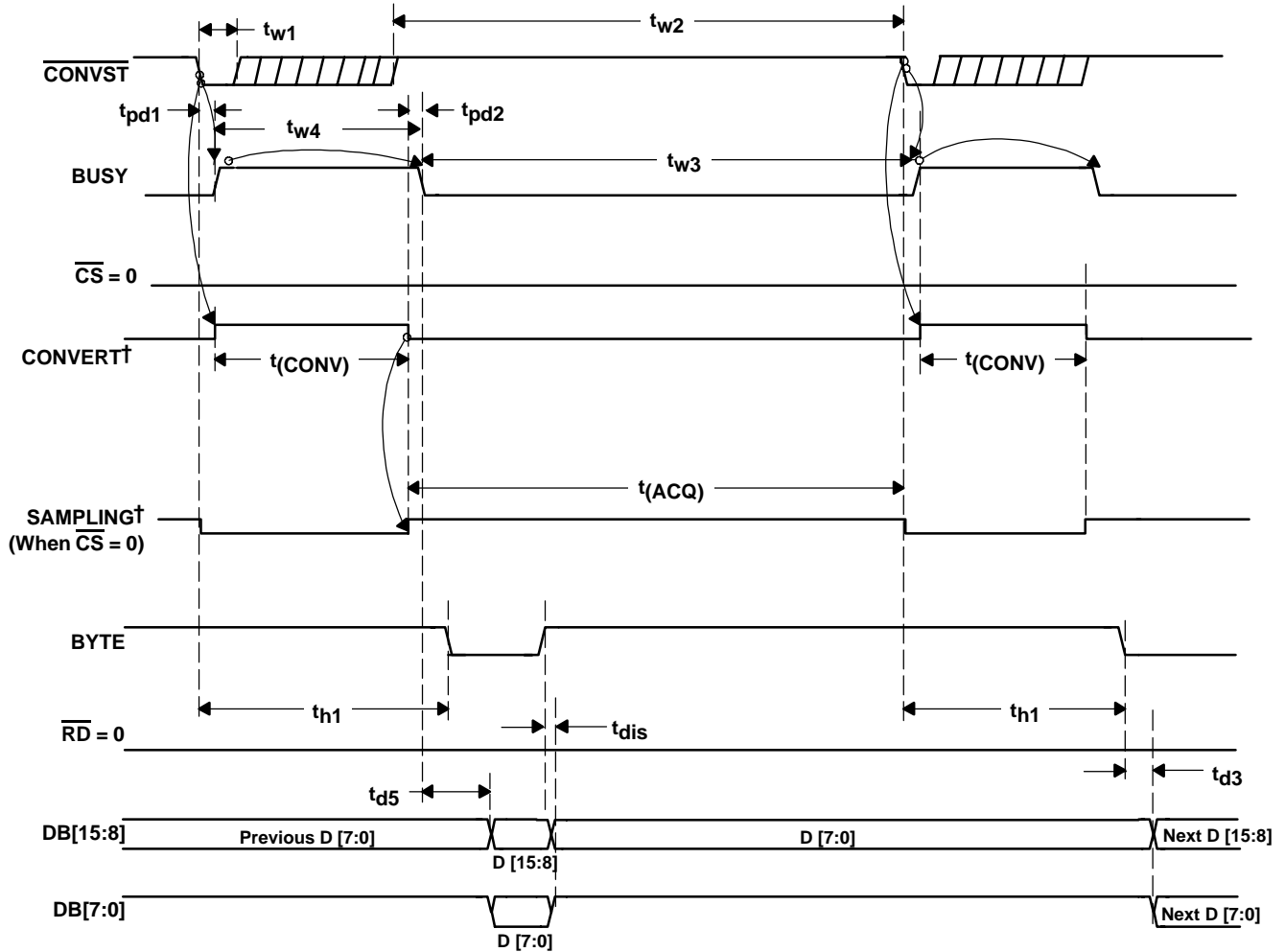

†Signal internal to device

Figure 4. Timing for Conversion and Acquisition Cycles With $\overline{\text{CS}}$ and $\overline{\text{RD}}$ Tied to BDGND—Auto Read

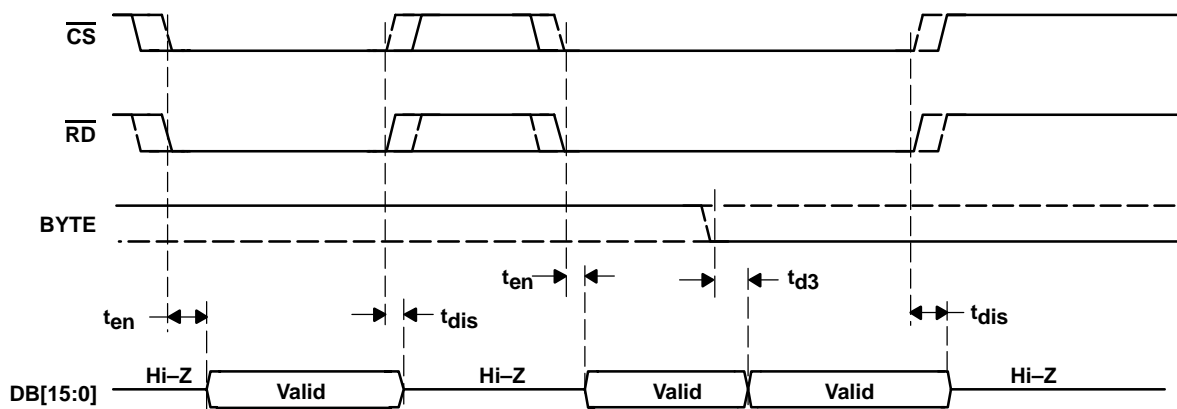

Figure 5. Detailed Timing for Read Cycles

TYPICAL CHARACTERISTICS†

HISTOGRAM (DC Code Spread)
NEAR POSITIVE FULL SCALE
196608 CONVERSIONS

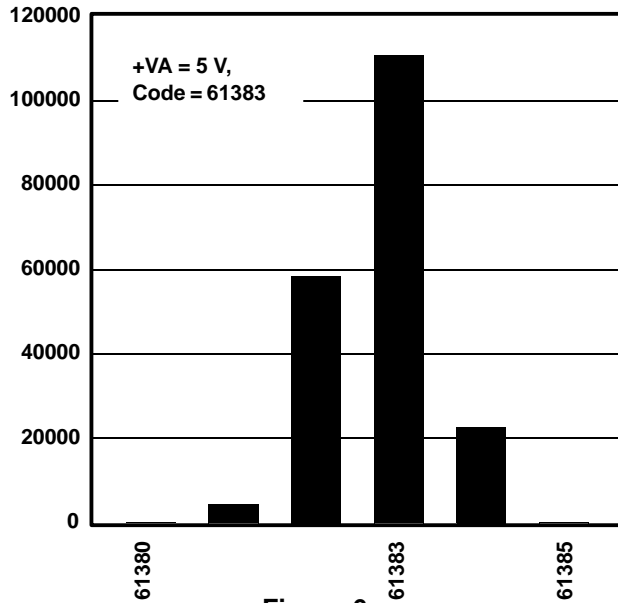

Figure 6

SIGNAL-TO-NOISE RATIO
vs
FREE-AIR TEMPERATURE

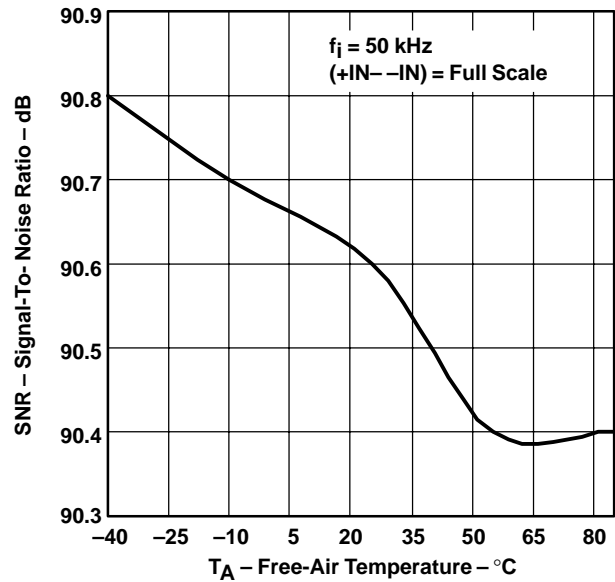

Figure 7

SIGNAL-TO-NOISE PLUS DISTORTION
vs
FREE-AIR TEMPERATURE

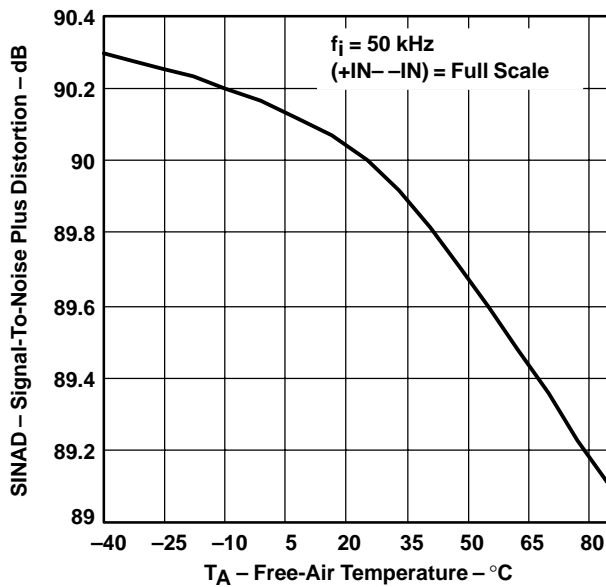

Figure 8

SPURIOUS FREE-DYNAMIC RANGE
vs
FREE-AIR TEMPERATURE

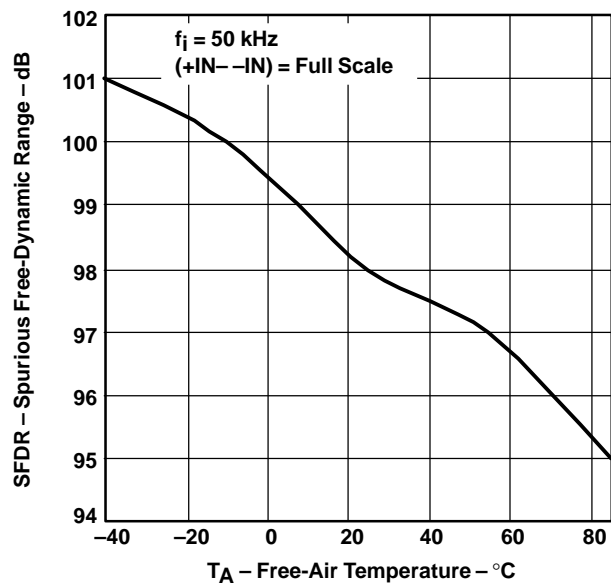

Figure 9

† At -40°C to 85°C, +VA = 5 V, +VBD = 5 V, REFIN = 4.096 V (internal reference used) and $f_{\text{sample}} = 1.25 \text{ MHz}$ (unless otherwise noted)

TOTAL HARMONIC DISTORTION
VS
FREE-AIR TEMPERATURE

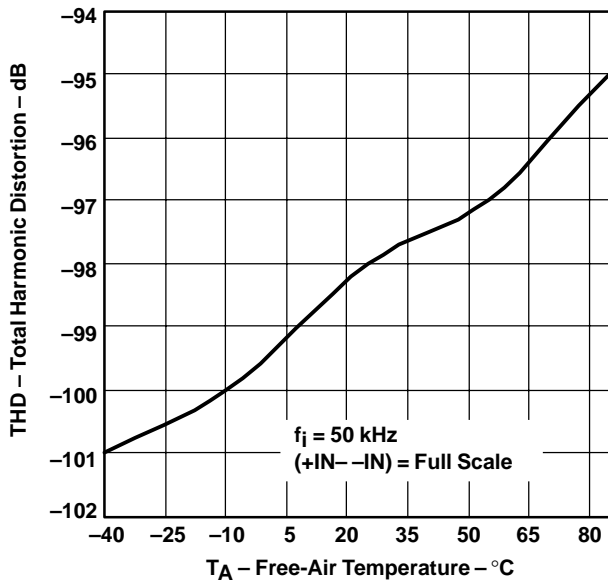

Figure 10

SIGNAL-TO-NOISE RATIO
VS
INPUT FREQUENCY

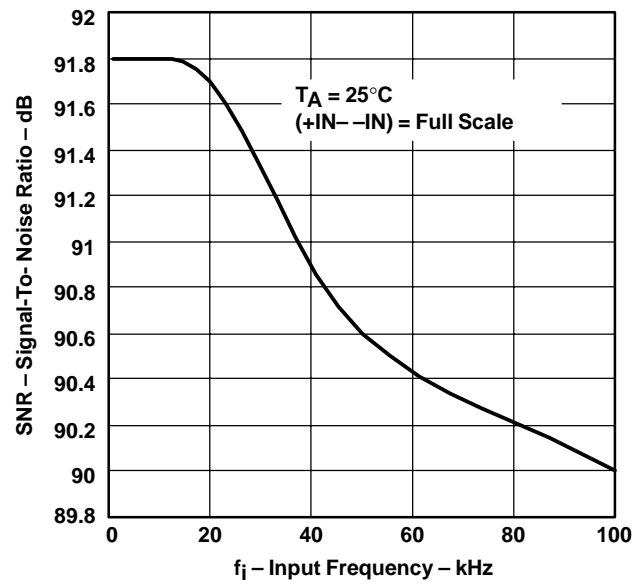

Figure 11

SIGNAL-TO-NOISE PLUS DISTORTION
VS
INPUT FREQUENCY

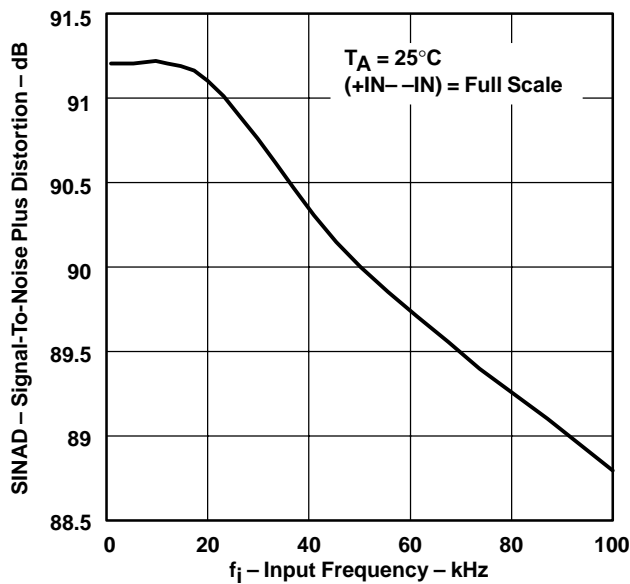

Figure 12

ENOB
VS
INPUT FREQUENCY

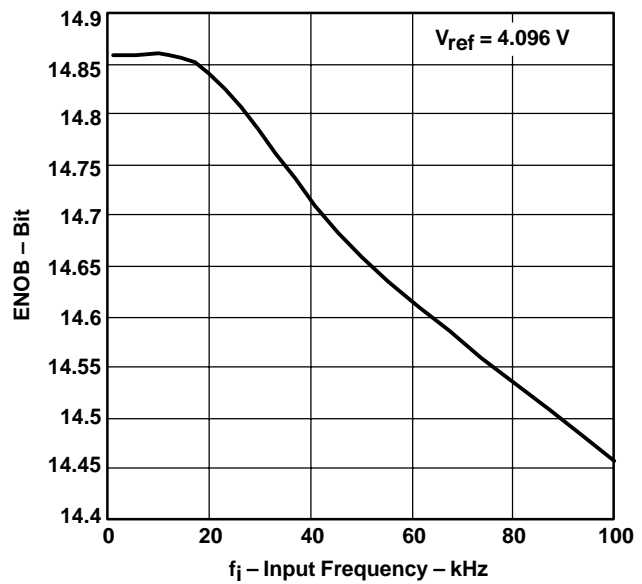

Figure 13

† At –40°C to 85°C, +V_A = 5 V, +V_{BD} = 5 V, REF_{IN} = 4.096 V (internal reference used) and f_{sample} = 1.25 MHz (unless otherwise noted)

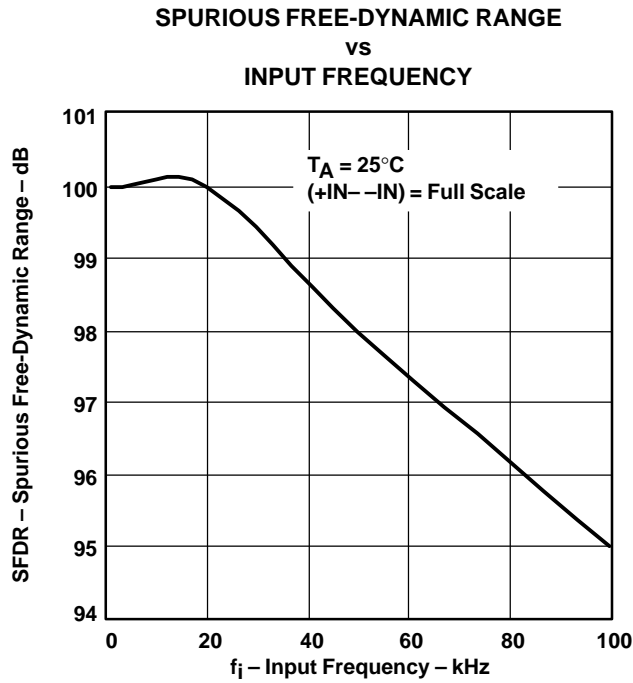

Figure 14

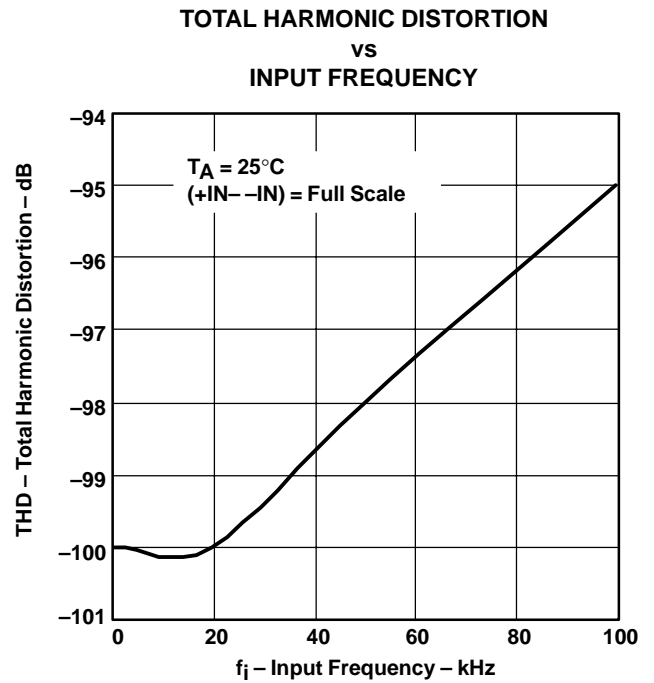

Figure 15

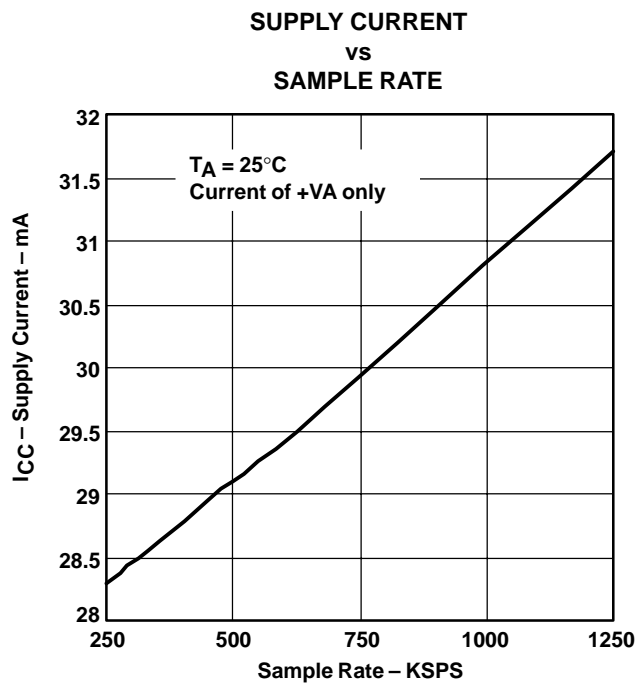

Figure 16

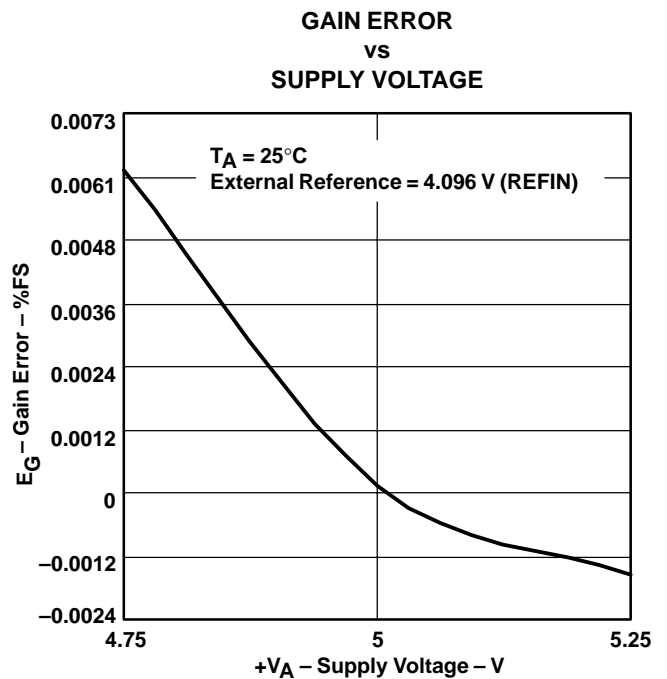

Figure 17

† At -40°C to 85°C , $+V_A = 5\text{ V}$, $+V_{BD} = 5\text{ V}$, $\text{REFIN} = 4.096\text{ V}$ (internal reference used) and $f_{\text{sample}} = 1.25\text{ MHz}$ (unless otherwise noted)

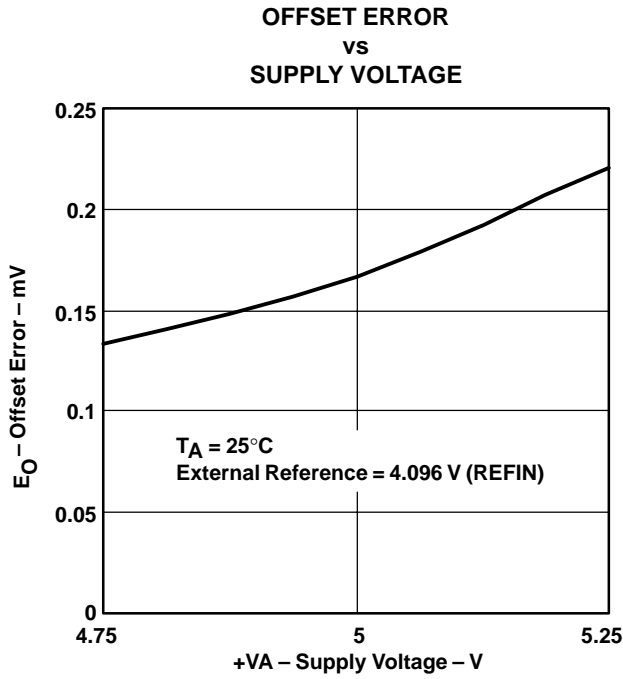

Figure 18

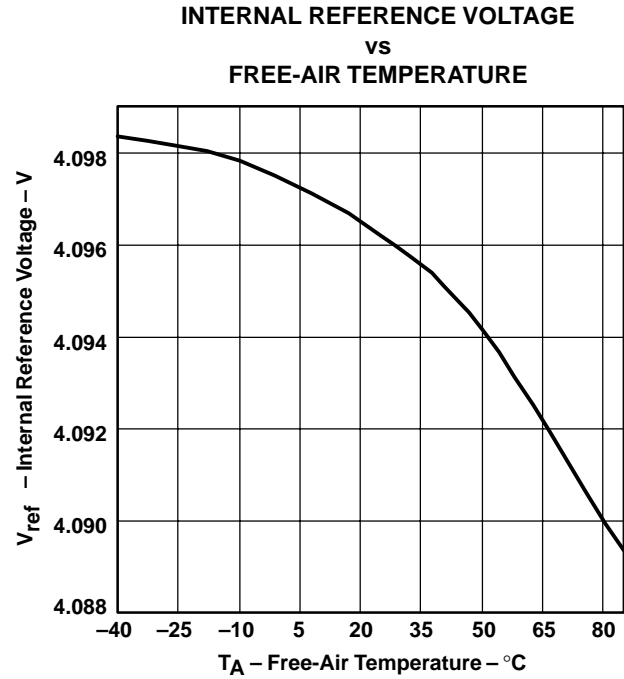

Figure 19

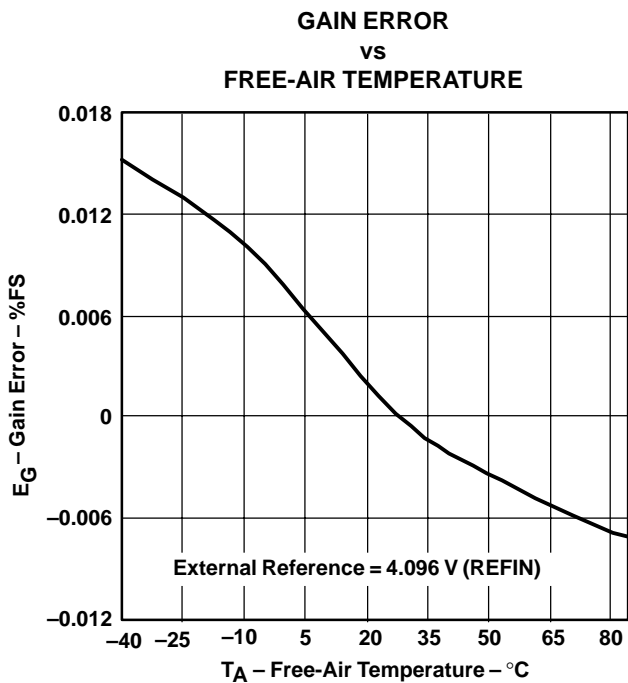

Figure 20

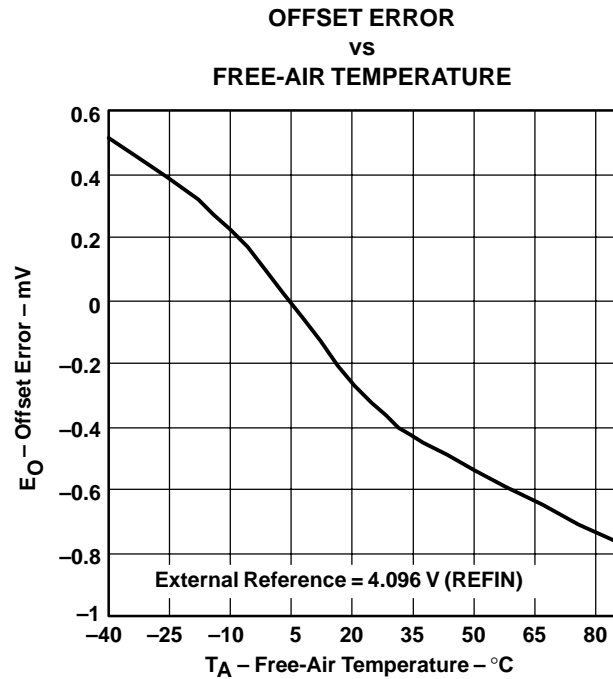

Figure 21

† At -40°C to 85°C, +VA = 5 V, +VBD = 5 V, REFIN = 4.096 V (internal reference used) and f_{sample} = 1.25 MHz (unless otherwise noted)

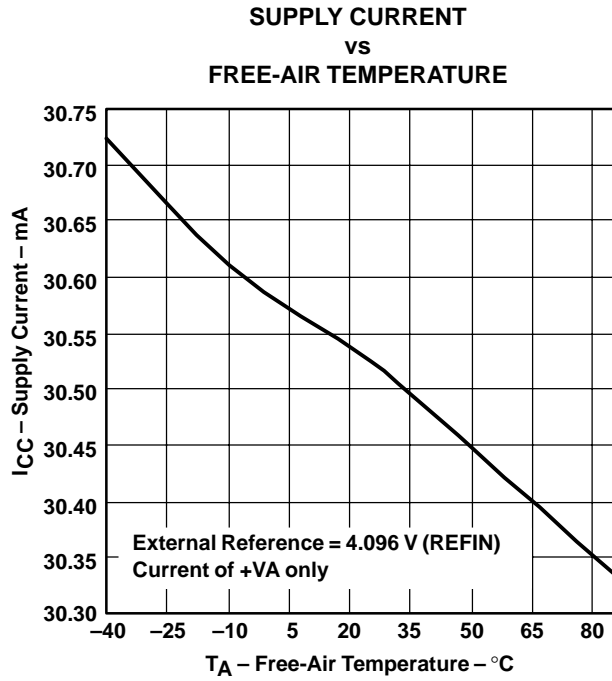

Figure 22

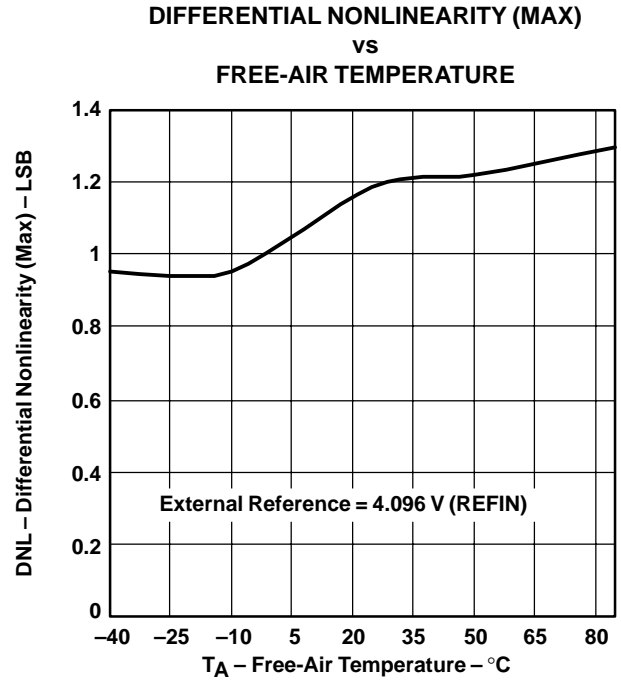

Figure 23

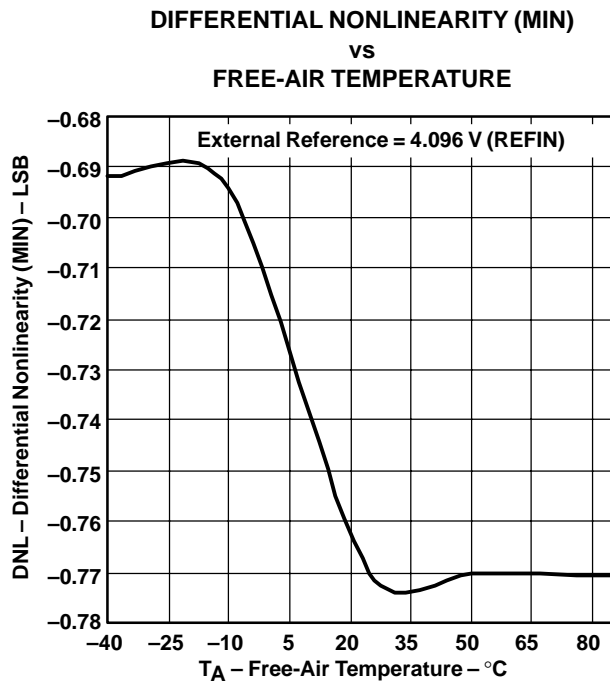

Figure 24

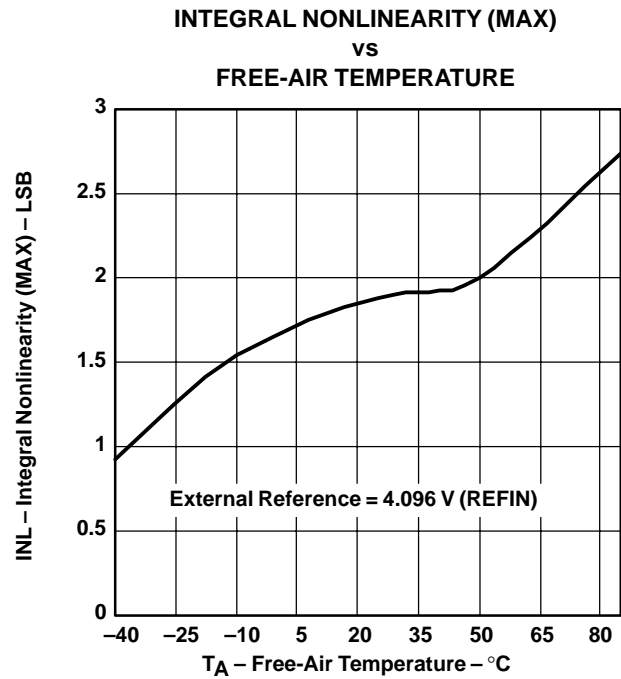

Figure 25

† At -40°C to 85°C, +VA = 5 V, +VBD = 5 V, REFIN = 4.096 V (internal reference used) and $f_{\text{sample}} = 1.25$ MHz (unless otherwise noted)

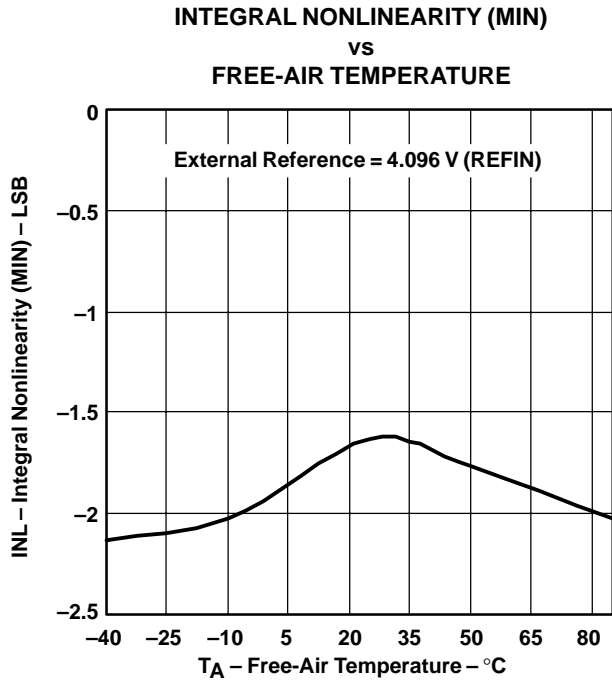

Figure 26

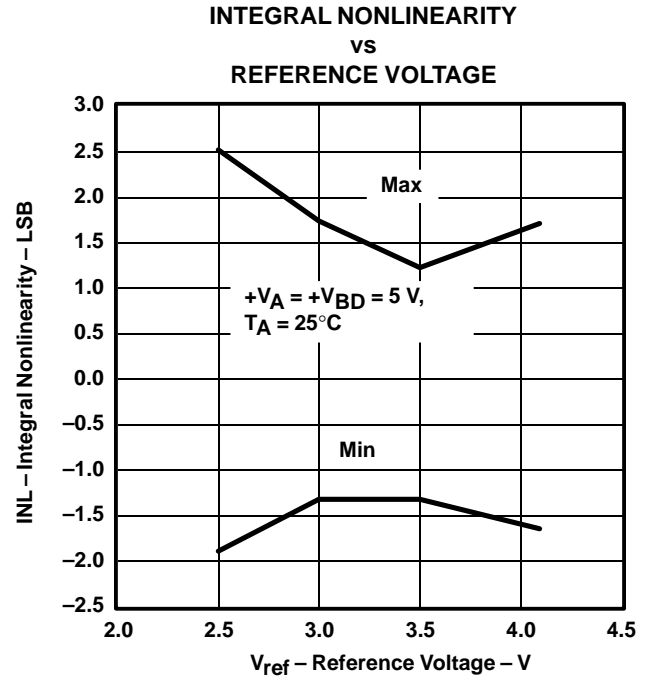

Figure 27

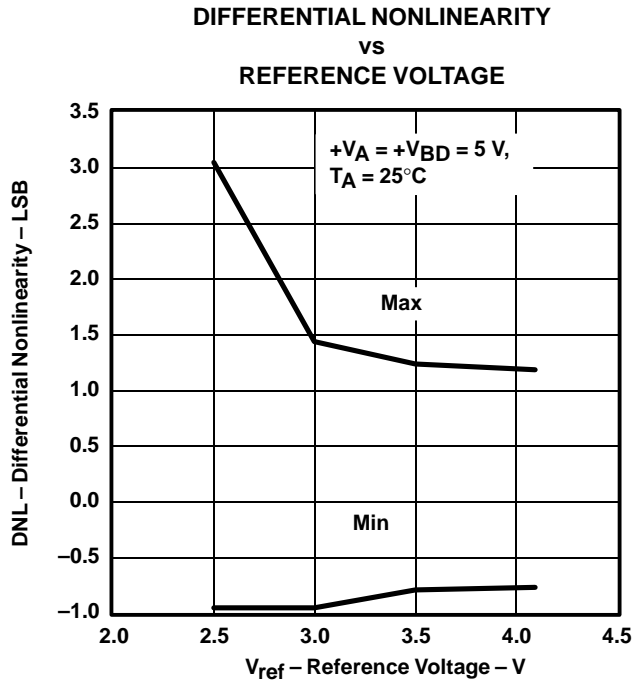
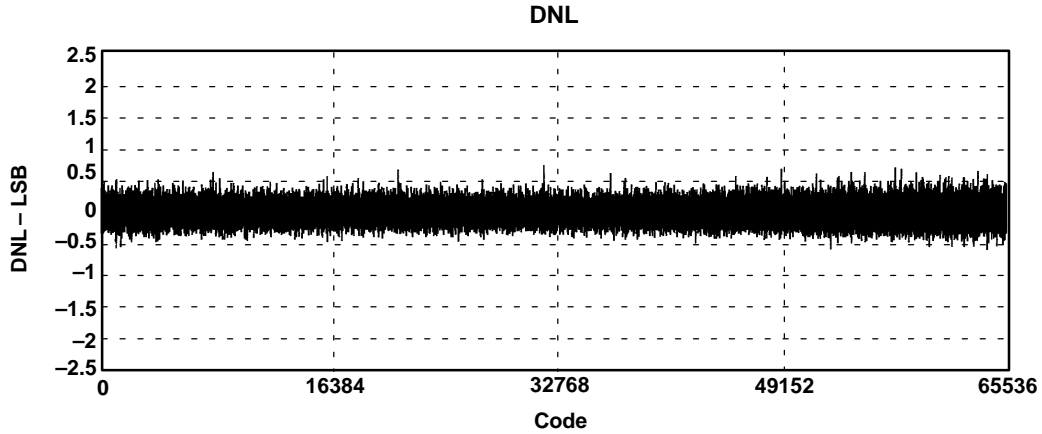

Figure 28

† At -40°C to 85°C, +VA = 5 V, +VBD = 5 V, REFIN = 4.096 V (internal reference used) and f_{sample} = 1.25 MHz (unless otherwise noted)



$T_A = 25^\circ\text{C}$, External Reference = 4.096 V (REFIN)

Figure 29

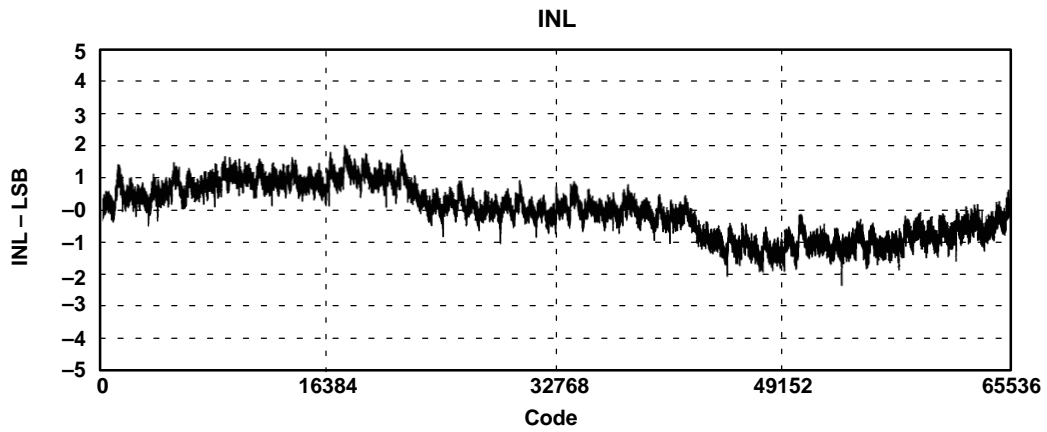

$T_A = 25^\circ\text{C}$, External Reference = 4.096 V (REFIN)

Figure 30

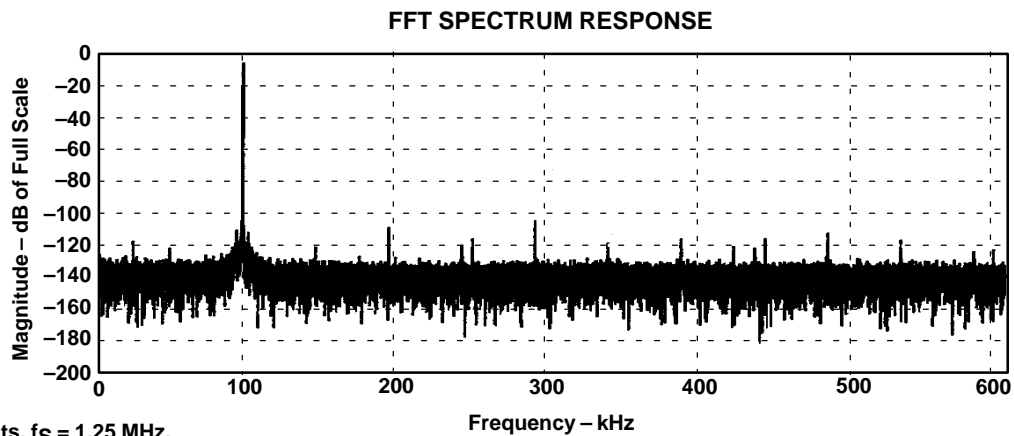

32768 Points, $f_S = 1.25$ MHz,
 Internal Reference = 4.096 V (REFIN),
 $T_A = 25^\circ\text{C}$, $f_i = 100$ kHz, (+IN – –IN) = Full Scale

Figure 31

† At -40°C to 85°C , $+V_A = 5$ V, $+V_{BD} = 5$ V, REFIN = 4.096 V (internal reference used) and $f_{\text{sample}} = 1.25$ MHz (unless otherwise noted)

APPLICATION INFORMATION

MICROCONTROLLER INTERFACING

ADS8402 to 8-Bit Microcontroller Interface

Figure 32 shows a parallel interface between the ADS8402 and a typical microcontroller using the 8-bit data bus. The BUSY signal is used as a falling-edge interrupt to the microcontroller.

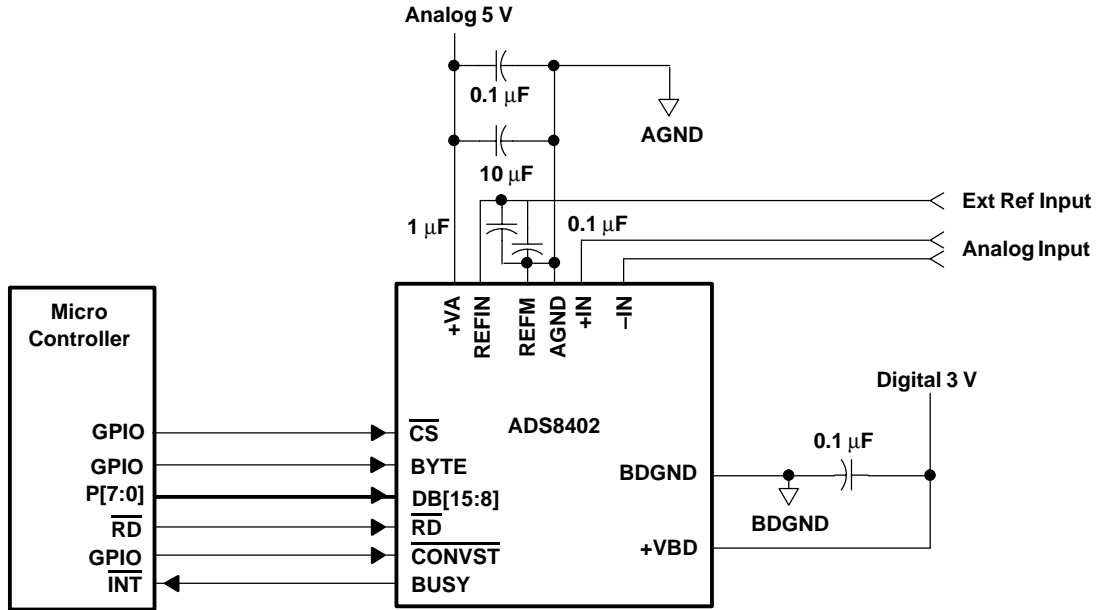

Figure 32. ADS8402 Application Circuitry (using external reference)

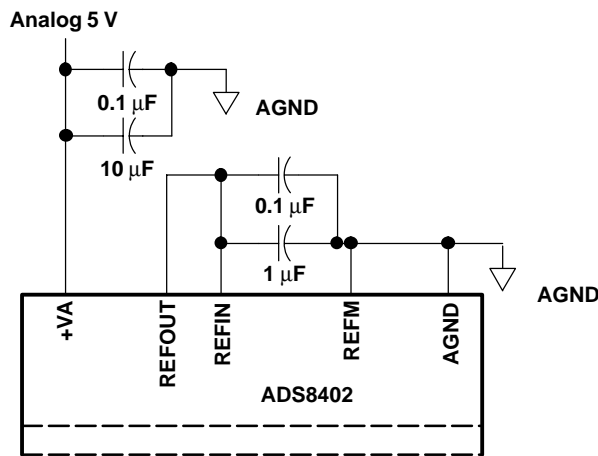

Figure 33. Use Internal Reference

PRINCIPLES OF OPERATION

The ADS8402 is a high-speed successive approximation register (SAR) analog-to-digital converter (ADC). The architecture is based on charge redistribution, which inherently includes a sample/hold function. See Figure 32 for the application circuit for the ADS8402.

The conversion clock is generated internally. The conversion time of 610 ns is capable of sustaining a 1.25-MHz throughput.

The analog input is provided to two input pins: +IN and –IN. When a conversion is initiated, the differential input on these pins is sampled on the internal capacitor array. While a conversion is in progress, both inputs are disconnected from any internal function.

REFERENCE

The ADS8402 can operate with an external reference with a range from 2.5 V to 4.2 V. A 4.096-V internal reference is included. When internal reference is used, pin 2 (REFOUT) should be connected to pin 1 (REFIN) with an 0.1 μ F decoupling capacitor and 1 μ F storage capacitor between pin 2 (REFOUT) and pins 47 and 48 (REFM) (see Figure 33). The internal reference of the converter is double buffered. If an external reference is used, the second buffer provides isolation between the external reference and the CDAC. This buffer is also used to recharge all of the capacitors of the CDAC during conversion. Pin 2 (REFOUT) can be left unconnected (floating) if external reference is used.

ANALOG INPUT

When the converter enters the hold mode, the voltage difference between the +IN and –IN inputs is captured on the internal capacitor array. Both +IN and –IN input has a range of -0.2 V to $V_{ref} + 0.2$ V. The input span (+IN – (–IN)) is limited to $-V_{ref}$ to V_{ref} .

The input current on the analog inputs depends upon a number of factors: sample rate, input voltage, and source impedance. Essentially, the current into the ADS8402 charges the internal capacitor array during the sample period. After this capacitance has been fully charged, there is no further input current. The source of the analog input voltage must be able to charge the input capacitance (25 pF) to an 16-bit settling level within the acquisition time (150 ns) of the device. When the converter goes into the hold mode, the input impedance is greater than 1 G Ω .

Care must be taken regarding the absolute analog input voltage. To maintain the linearity of the converter, the +IN and –IN inputs and the span (+IN – (–IN)) should be within the limits specified. Outside of these ranges, the converter's linearity may not meet specifications. To minimize noise, low bandwidth input signals with low-pass filters should be used.

Care should be taken to ensure that the output impedance of the sources driving +IN and –IN inputs are matched. If this is not observed, the two inputs could have different settling time. This may result in offset error, gain error and linearity error which varies with temperature and input voltage.

A typical input circuit using TI's THS4503 is shown in Figure 34. Input from a single-ended source may be converted into differential signal for ADS8402 as shown in the figure. In case the source itself is differential then THS4503 may be used in differential input and differential output mode.

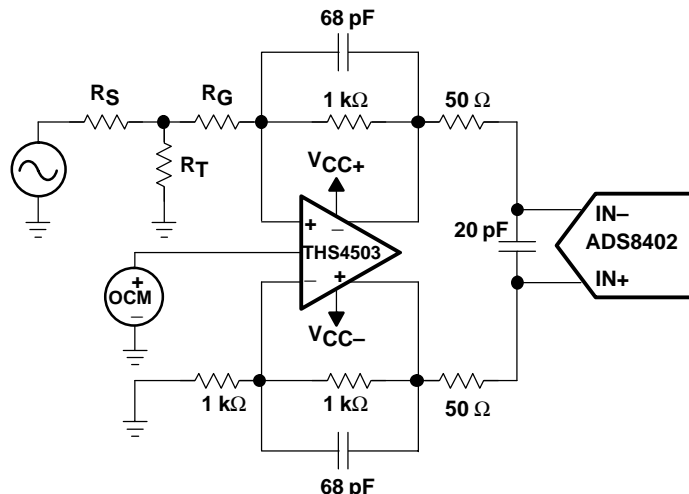

R_G , R_S , and R_T should be chosen such that
 $R_G + R_S \parallel R_T = 1 \text{ k}\Omega$
 $V_{OCM} = 2 \text{ V}$, $V_{CC+} = 7 \text{ V}$, and $V_{CC-} = -7 \text{ V}$

Figure 34. Using THS4503 With ADS8402

DIGITAL INTERFACE

Timing and Control

See the timing diagrams in the specifications section for detailed information on timing signals and their requirements.

The ADS8402 uses an internal oscillator generated clock which controls the conversion rate and in turn the throughput of the converter. No external clock input is required.

Conversions are initiated by bringing the $\overline{\text{CONVST}}$ pin low for a minimum of 20 ns (after the 20 ns minimum requirement has been met, the $\overline{\text{CONVST}}$ pin can be brought high), while $\overline{\text{CS}}$ is low. The ADS8402 switches from the sample to the hold mode on the falling edge of the $\overline{\text{CONVST}}$ command. A clean and low jitter falling edge of this signal is important to the performance of the converter. The $\overline{\text{BUSY}}$ output is brought high after $\overline{\text{CONVST}}$ goes low. $\overline{\text{BUSY}}$ stays high throughout the conversion process and returns low when the conversion has ended.

Sampling starts with the falling edge of the $\overline{\text{BUSY}}$ signal when $\overline{\text{CS}}$ is tied low or starts with the falling edge of $\overline{\text{CS}}$ when $\overline{\text{BUSY}}$ is low.

Both $\overline{\text{RD}}$ and $\overline{\text{CS}}$ can be high during and before a conversion with one exception ($\overline{\text{CS}}$ must be low when $\overline{\text{CONVST}}$ goes low to initiate a conversion). Both the $\overline{\text{RD}}$ and $\overline{\text{CS}}$ pins are brought low in order to enable the parallel output bus with the conversion.

Reading Data

The ADS8402 outputs full parallel data in two's complement format as shown in Table 1. The parallel output is active when $\overline{\text{CS}}$ and $\overline{\text{RD}}$ are both low. There is a minimal quiet zone requirement around the falling edge of $\overline{\text{CONVST}}$. This is 100 ns prior to the falling edge of $\overline{\text{CONVST}}$ and 40 ns after the falling edge. No data read should be attempted within this zone. Any other combination of $\overline{\text{CS}}$ and $\overline{\text{RD}}$ sets the parallel output to 3-state. $\overline{\text{BYTE}}$ is used for multiword read operations. $\overline{\text{BYTE}}$ is used whenever lower bits of the conversion result are output on the higher byte of the bus. Refer to Table 1 for ideal output codes.

Table 1. Ideal Input Voltages and Output Codes

DESCRIPTION	ANALOG VALUE	DIGITAL OUTPUT TWOS COMPLEMENT	
		FULL SCALE RANGE	
Least significant bit (LSB)	$2V_{ref}/65536$	BINARY CODE	HEX CODE
Full scale	V_{ref}	0111 1111 1111 1111	7FFF
Midscale	0	0000 0000 0000 0000	0000
Zero	$-V_{ref}$	1000 0000 0000 0000	8000

The output data is a full 16-bit word (D15–D0) on DB15–DB0 pins (MSB–LSB) if BYTE is low.

The result may also be read on an 8-bit bus for convenience. This is done by using only pins DB15–DB8. In this case two reads are necessary: the first as before, leaving BYTE low and reading the 8 most significant bits on pins DB15–DB8, then bringing BYTE high, the low bits (D7–D0) appears on pins DB15–D8.

These multiword read operations can be done with multiple active \overline{RD} (toggling) or with \overline{RD} tied low for simplicity.

BYTE	DATA READ OUT	
	DB15–DB8	DB7–DB0
High	D7–D0	All one's
Low	D15–D8	D7–D0

RESET

\overline{RESET} is an asynchronous active low input signal (that works independantly of \overline{CS}). Minimum \overline{RESET} low time is 20 ns. Current conversion will be aborted no later than 50 ns after the converter is in the reset mode. In addition, all output latches are cleared (set to zero's) after \overline{RESET} . The converter goes back to normal operation mode no later than 20 ns after \overline{RESET} input is brought high.

The converter starts the first sampling period 20 ns after the rising edge of \overline{RESET} . Any sampling period except for the one immediately after a \overline{RESET} is started with the falling edge of the previous BUSY signal or the falling edge of CS, whichever is later.

POWER-ON INITIALIZATION

One \overline{RESET} pulse followed by three conversion cycles must be given to the converter after powerup to ensure proper operation. The next pulse can be issued once both +VA and +VBD reach 95% of the minimum required value.

LAYOUT

For optimum performance, care should be taken with the physical layout of the ADS8402 circuitry.

As the ADS8402 offers single-supply operation, it is often used in close proximity with digital logic, microcontrollers, microprocessors, and digital signal processors. The more digital logic present in the design and the higher the switching speed, the more difficult it is to achieve good performance from the converter.

The basic SAR architecture is sensitive to glitches or sudden changes on the power supply, reference, ground connections and digital inputs that occur just prior to latching the output of the analog comparator. Thus, driving any single conversion for an n-bit SAR converter, there are at least n *windows* in which large external transient voltages can affect the conversion result. Such glitches might originate from switching power supplies, nearby digital logic, or high power devices.

The degree of error in the digital output depends on the reference voltage, layout, and the exact timing of the external event.

On average, the ADS8402 draws very little current from an external reference, as the reference voltage is internally buffered. If the reference voltage is external and originates from an op amp, make sure that it can drive the bypass capacitor or capacitors without oscillation. A 0.1- μ F bypass capacitor and 1- μ F storage capacitor are recommended from pin 1 (REFIN) directly to pin 48 (REFM). REFM and AGND should be shorted on the same ground plane under the device.

The AGND and BDGND pins should be connected to a clean ground point. In all cases, this should be the analog ground. Avoid connections which are close to the grounding point of a microcontroller or digital signal processor. If required, run a ground trace directly from the converter to the power supply entry point. The ideal layout consists of an analog ground plane dedicated to the converter and associated analog circuitry.

As with the AGND connections, +VA should be connected to a 5-V power supply plane or trace that is separate from the connection for digital logic until they are connected at the power entry point. Power to the ADS8402 should be clean and well bypassed. A 0.1- μ F ceramic bypass capacitor should be placed as close to the device as possible. See Table 2 for the placement of the capacitor. In addition, a 1- μ F to 10- μ F capacitor is recommended. In some situations, additional bypassing may be required, such as a 100- μ F electrolytic capacitor or even a Pi filter made up of inductors and capacitors—all designed to essentially low-pass filter the 5-V supply, removing the high frequency noise.

Table 2. Power Supply Decoupling Capacitor Placement

POWER SUPPLY PLANE SUPPLY PINS	CONVERTER ANALOG SIDE	CONVERTER DIGITAL SIDE
Pin pairs that require shortest path to decoupling capacitors	(4,5), (8,9), (10,11), (13,15), (43,44), (45,46)	(24,25), (34, 35)
Pins that require no decoupling	12, 14	37

IMPORTANT NOTICE

Texas Instruments Incorporated and its subsidiaries (TI) reserve the right to make corrections, modifications, enhancements, improvements, and other changes to its products and services at any time and to discontinue any product or service without notice. Customers should obtain the latest relevant information before placing orders and should verify that such information is current and complete. All products are sold subject to TI's terms and conditions of sale supplied at the time of order acknowledgment.

TI warrants performance of its hardware products to the specifications applicable at the time of sale in accordance with TI's standard warranty. Testing and other quality control techniques are used to the extent TI deems necessary to support this warranty. Except where mandated by government requirements, testing of all parameters of each product is not necessarily performed.

TI assumes no liability for applications assistance or customer product design. Customers are responsible for their products and applications using TI components. To minimize the risks associated with customer products and applications, customers should provide adequate design and operating safeguards.

TI does not warrant or represent that any license, either express or implied, is granted under any TI patent right, copyright, mask work right, or other TI intellectual property right relating to any combination, machine, or process in which TI products or services are used. Information published by TI regarding third-party products or services does not constitute a license from TI to use such products or services or a warranty or endorsement thereof. Use of such information may require a license from a third party under the patents or other intellectual property of the third party, or a license from TI under the patents or other intellectual property of TI.

Reproduction of information in TI data books or data sheets is permissible only if reproduction is without alteration and is accompanied by all associated warranties, conditions, limitations, and notices. Reproduction of this information with alteration is an unfair and deceptive business practice. TI is not responsible or liable for such altered documentation.

Resale of TI products or services with statements different from or beyond the parameters stated by TI for that product or service voids all express and any implied warranties for the associated TI product or service and is an unfair and deceptive business practice. TI is not responsible or liable for any such statements.

Mailing Address:

Texas Instruments
Post Office Box 655303
Dallas, Texas 75265