

## Overview

SEN-30006 is a dual (two) channel, high precision and high accuracy thermocouple shield based on the MAX31856 by Maxim Integrated and supplied in a “breakout board” form factor. Multiple thermocouple variants are stocked, as well as “universal” configurations. Mini flat-blade thermocouples are supported by the type-specific variants. Universal thermocouple types are supported by screw-terminal and spring-clamp variants using bare wire connections.

## Features

- Dual MAX31856 Thermocouple
- “Breakout Board” form factor with 3.0V - 5.5V compliant supply and I/O range
- B-, E-, J-, K-, N-, R-, S-, and T-type thermocouple support
- 19-bit hot-junction temperature resolution (0.0078125°C/bit) with 0.15% TC voltage accuracy
- 6-bit cold junction resolution (0.015625°C/bit) ±0.7°C accuracy
- Thermocouple nonlinearity correction
- Multi-fault detection: Short-to-Gnd, Short-to-Vcc, Open thermocouple
- RoHS Compliant

## Kit Includes

- SEN-30006-(x) breakout board, fully assembled

## Typical Applications

- Automotive temperature sensing (exhaust, coolant, brakes, etc)
- Industrial instrumentation
- Oven controls
- Home brewing controls
- Hobby applications

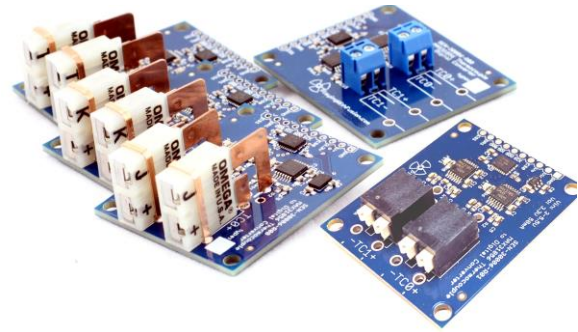

## Description

Maxim has evolved their thermocouple measurement line from the MAX6674 and MAX6675, to the MAX31855, and now, the MAX31856. With the advent of the MAX31856, it is now possible to use a single IC to measure virtually any thermocouple type. However, care must still be taken to ensure consistent junction transitions to avoid unexpected errors. We accomplish this by offering the SEN-30006 in many different configurations. See Table 1 below for the different ordering codes, and the Appendix for pictures of the different configurations. Please note, we also offer [single](#), [quad](#), and [Arduino Shield](#) options for MAX31856 Thermocouple measurement.

Table 1: Orderable Parts

PwF Part No.	Connector	Thermocouple Type
SEN-30006-J	Mini-blade TC	J-type only
SEN-30006-K	Mini-blade TC	K-type only
SEN-30006-T	Mini-blade TC	T-type only
SEN-30006-ST	screw terminal	universal, bare wire
SEN-30006-W	push-release spring clamp	universal, bare wire

All SEN-30006 boards include analog filtering on each thermocouple channel. This includes both common- and differential-mode filtering, which compliments the on-chip notch filter for mains frequency noise (50hz or 60hz). This ensures a steady and reliable temperature reading.

Measurements from the MAX31856 are accessed via a 4-wire SPI interface and

individual Chip-Select lines. All signals are accessed via the 10-pin header along the back of the board, and only 7 connections are required for full operation of the board. Multiple boards can be wired together to increase channel count on a single microcontroller. (see our [GitHub Page](#) for an example 12-channel MAX31856 datalogger)

While the MAX31856 is a 3.3V (nominal) part, all SPI signals are level shifted to “Vin” using high speed translator ICs. An onboard LDO provides the MAX31856 ICs with clean, 3.3V power. This makes the MAX31856 suitable for any microcontroller or interface device operating between 3.0V and 5.5V.

### Application & Guide

SEN-30006 is designed for rapid setup and integration. We have provided several code examples on our [GitHub Page](#) designed to get you up and running quickly.

### QuickStart

Note: ALL SEN-30006 boards use the same PCB, but have different connectors to match the application.

- 1) Start by soldering fly-wires or a straight header (not included) on the SEN-30006.
- 2) Connect the Vin and GND pins to a voltage supply that matches your microcontroller or interface module.
- 3) Connect at least the SPI (SDO/SDI/SCK) and CSx lines to your microcontroller. DRx pins are not required, and no PwFusion example uses them
- 4) Please note, the 3.3V pin is *NOT* an input, but it can be used to power an external device up to 100mA. It is powered by the onboard LDO.

- 5) Download the [PwFusion example code from GitHub](#), flash your board, and connect your thermocouples. Any thermocouple channel that isn't plugged will have an illuminated LED showing a fault on that channel (Open, in this case). Other channels will be reading via the serial monitor (be sure to set your baud rate to 115,200).

### Advanced User

The PwFusion library can be used to change many of the settings on the MAX31856 based on descriptions in the datasheet. Things like the number of samples to average, notch filter frequency, faults to display, and high- and low-temperature triggers can all be configured via the SPI interface. It is recommended to spend some time with the MAX31856 datasheet once you have gotten the SEN-30006 up and running to ensure optimal performance in your application.

### Common Issues

- Not installing all required connections. Vin, GND, SPI (SDO/SDI/SCK), and all 4 CS pins must be connected to function.
- Conflicting Chip Selects
  - Our example code shows using Arduino pins D7-D10 by default, but you can switch this to anything. This is *required* if you have connected something else to pins D7-D10.
  - Remember, many pins on microcontroller carrier boards, like the Arduino and Raspberry Pi, are often used for alternate functions. For example, D0/D1 are used for serial, and D11-D13 for SPI on an Arduino Uno R3. These can NOT be shared with CS pins

- Conflicting SPI modes when used with other boards or modules
  - MAX31856 uses SPI Modes 1 or 3, while many Ethernet controllers and SD cards use Mode 0.
  - Be sure to switch between modes before calling functions for the specific device you are talking to.
  - We show an example of how to handle this in our [12-channel TC logger](#) example on GitHub
- Strange or inconsistent readings with multiple grounded thermocouples
  - Common mode range can result in erroneous readings when the thermocouple is grounded
  - MAX31856 is typically used for ungrounded thermocouple measurement
  - Try to select ungrounded thermocouples, when possible
  - If you see issues and must use grounded thermocouples, [contact us](#) to explore what we have available for isolated thermocouple products
- Bare wire thermocouple leads not wanting to stay inserted
  - Switch to “W” universal spring clamp connectors or type-specific connectors for industrial and automotive (high vibration) applications

### **Ordering Options & Related Parts**

[SEN-30006-J](#): Dual MAX31856 TC breakout, J-type flat-blade connectors

[SEN-30006-K](#): Dual MAX31856 TC breakout, K-type flat-blade connectors

[SEN-30006-T](#): Dual MAX31856 TC breakout, T-type flat-blade connectors

[SEN-30006-ST](#): Dual MAX31856 TC breakout, screw terminal connectors

[SEN-30006-W](#): Dual MAX31856 TC breakout, spring-clamp connector

[SEN-30005](#): Single MAX31856 Breakout

[SEN-30007](#): Quad MAX31856 TC shield

[SEN-30008](#): Quad MAX31856 TC breakout

[SEN-30010](#): Single MCP9601 Thermocouple breakout, Qwiic I2C interface

[SEN-30011](#): Quad MCP9601 thermocouple shield/breakout, Qwiic I2C interface

[IFB-10011](#): Qwiic-compatible I2C MUX based on TCA9548A

[WIR-10001](#): 10cm Qwiic-compatible interconnect cable

[SEN-30202](#): Dual MAX31865 RTD, SPI interface

Appendix 1a: Mech Drawing, Mini TC  
Connectors (Top View)

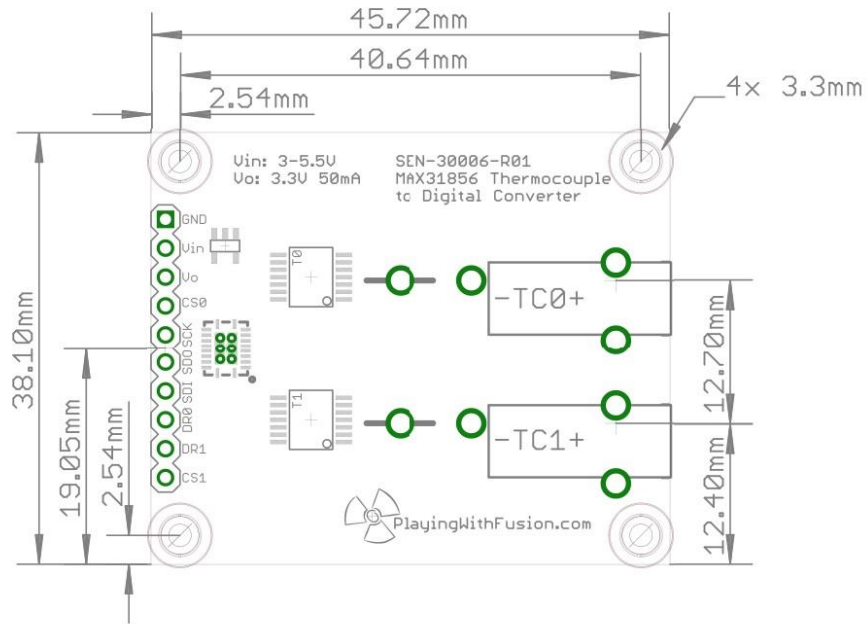

Appendix 1b: Mech Drawing, W and ST  
Connectors (Top View)

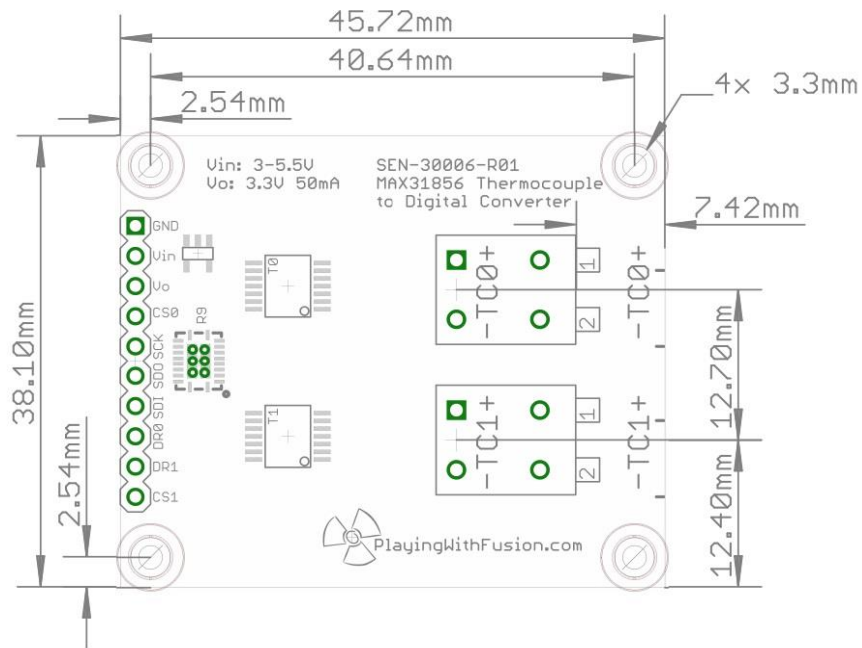

Appendix 2a: SEN-30006, J-Type

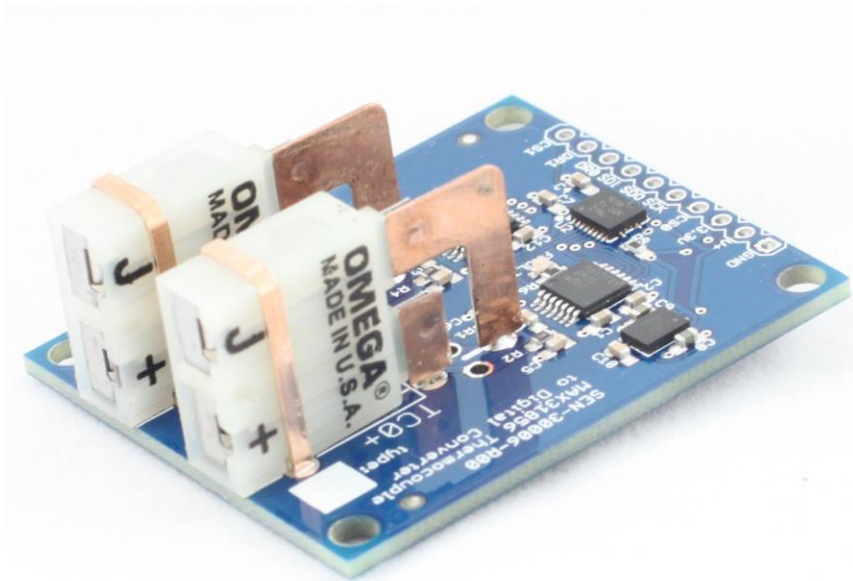

Appendix 2b: SEN-30006, K-Type

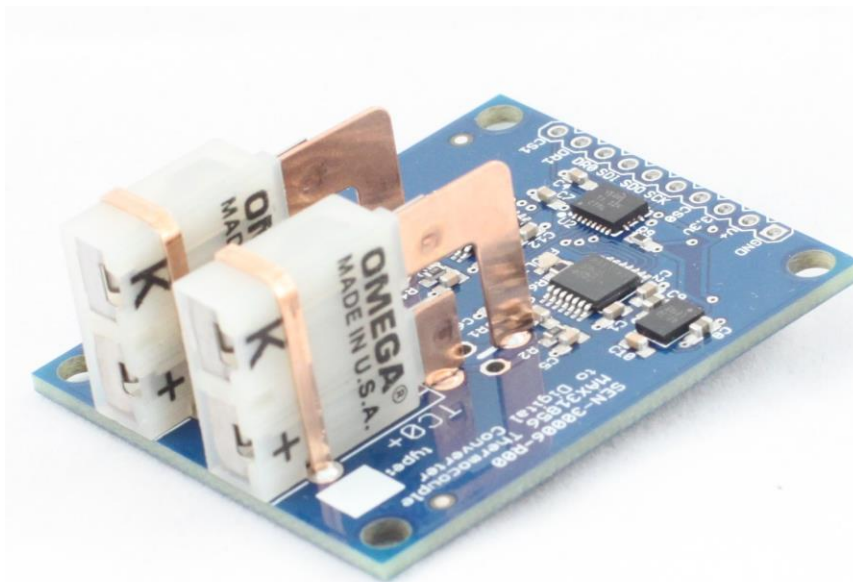

Appendix 2c: SEN-30006, T-Type

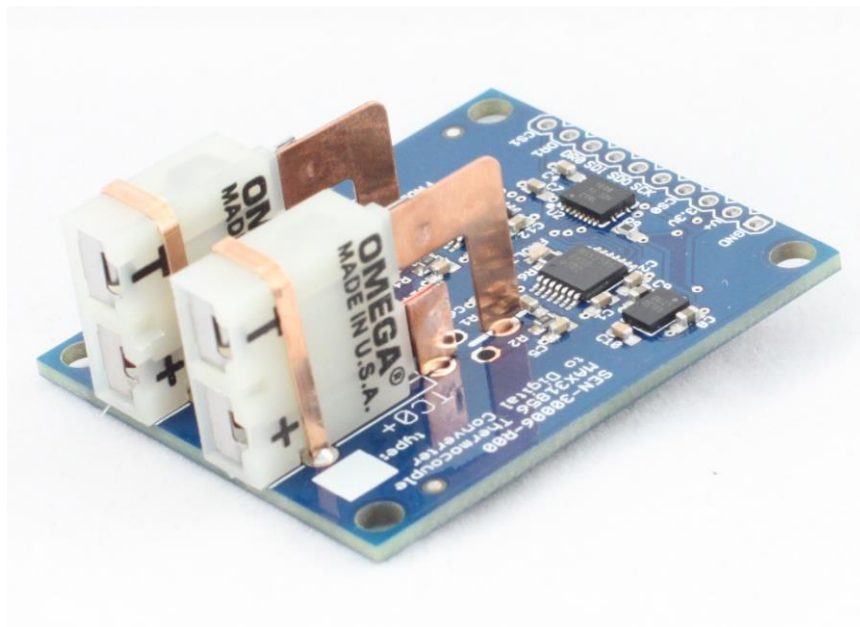

Appendix 2d: SEN-30006, Screw Terminal

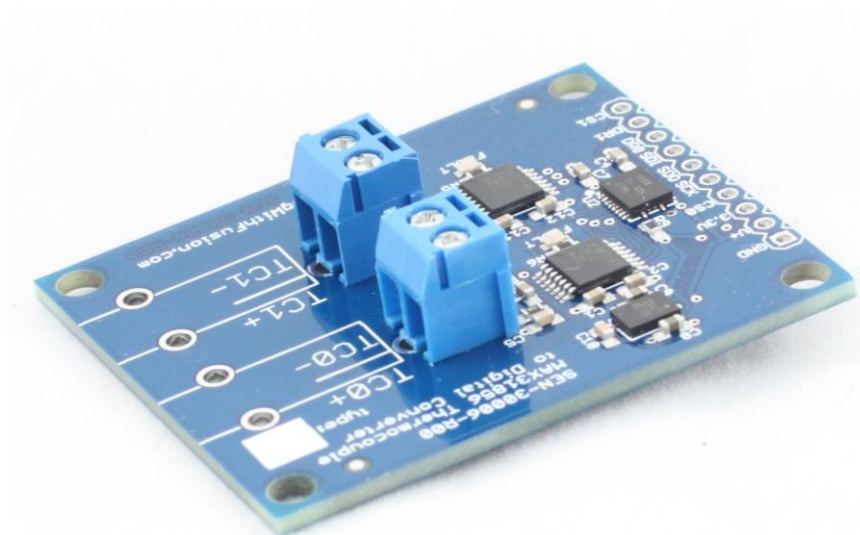

Appendix 2e: SEN-30006, Spring Clamp  
with Release

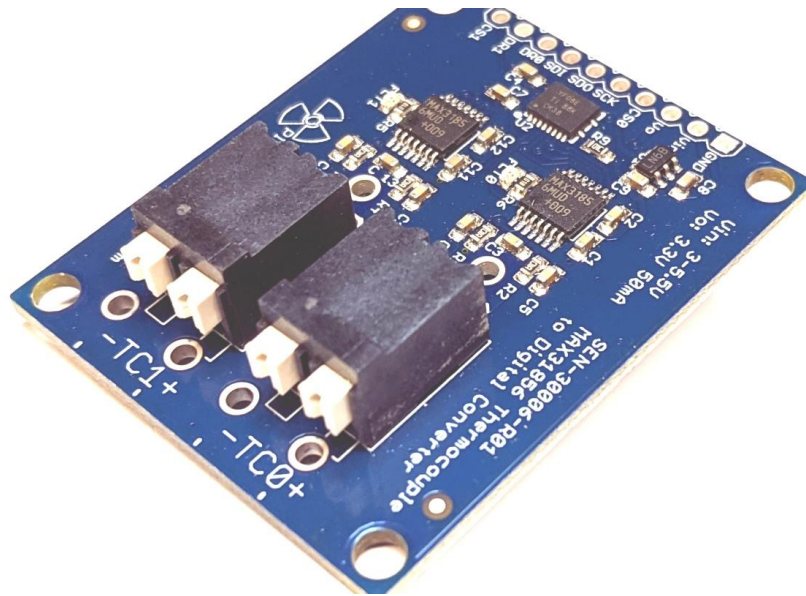

---

### Revision History

Date	Author	Notes
03/16/2021	J. Steinlage	Add pictures