

Isolator  
SMD



# CU4S0508 Series



## PART NUMBER CONSTRUCTION

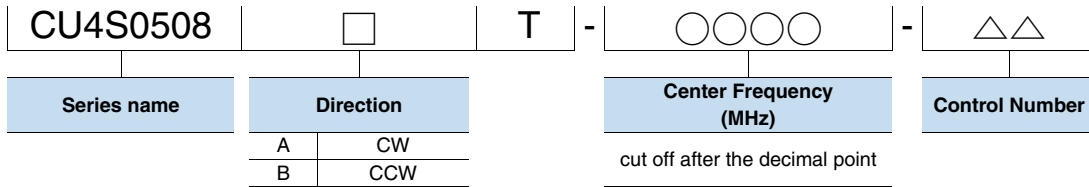

## DIRECTION OF CIRCULATION

ClockWise(CW): A

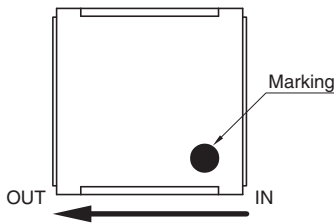

CounterClockWise(CCW): B

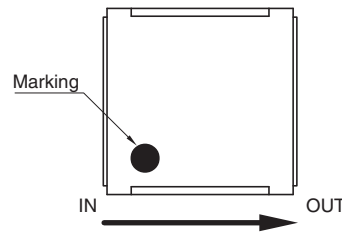

## ELECTRICAL CHARACTERISTICS

Frequency range (MHz)	Center frequency (MHz)	Isolation (dB) min.	Insertion loss (dB) max.	V.S.W.R. Zo=50Ω max.	Handling power (W) max.	Reflection power (W) <sup>*4</sup> max.	Part Number	
							ClockWise	CounterClockWise
3300 to 3600	3450	10	1.00	1.8	5	2	<a href="#">CU4S0508AT-3450-00</a>	<a href="#">CU4S0508BT-3450-00</a>
3500 to 3700	3600	10	1.00	1.8	5	2	<a href="#">CU4S0508AT-3600-00</a>	<a href="#">CU4S0508BT-3600-00</a>

Characteristic Impedance (Ω) : 50(Nominal)

<sup>\*4</sup> To be kept below +105deg.C at the bottom surface

## TEMPERATURE RANGE

Operating temperature (°C)	Storage temperature (°C)
-40 to +105	-40 to +105

⚠ Please be sure to request delivery specifications that provide further details on the features and specifications of the products for proper and safe use. Please note that the contents may change without any prior notice due to reasons such as upgrading.

# CU4S0508 Series

## SHAPES AND DIMENSIONS

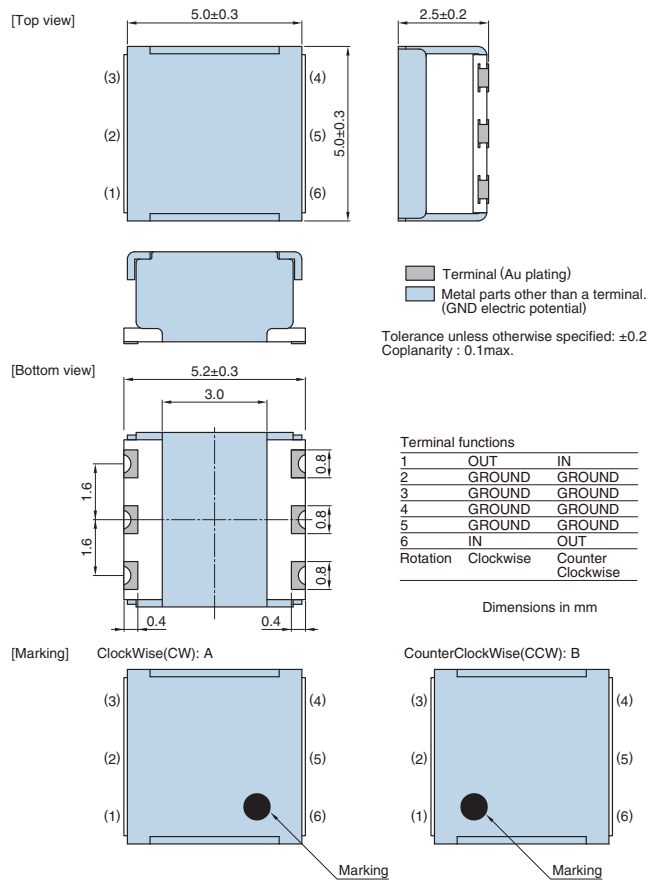

## RECOMMENDED REFLOW PROFILE

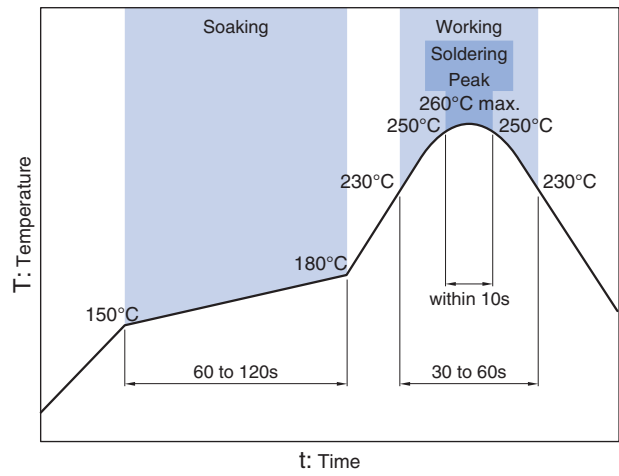

## PACKAGING STYLE

### REEL DIMENSIONS

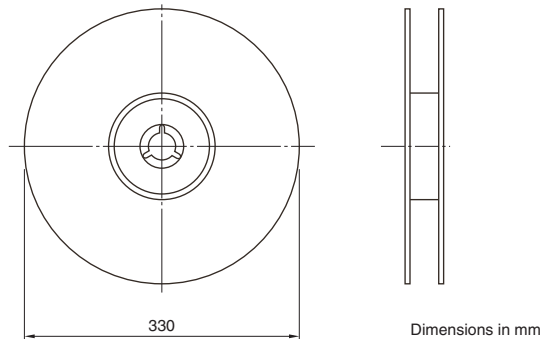

## RECOMMENDED LAND PATTERN

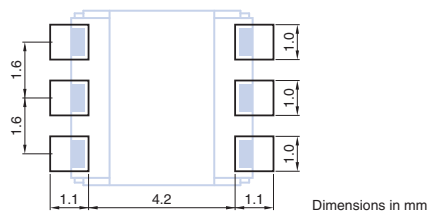

### TAPE DIMENSIONS

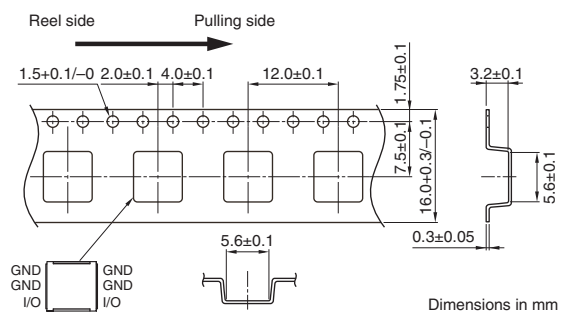

## RECOMMENDED PC BOARD PATTERN

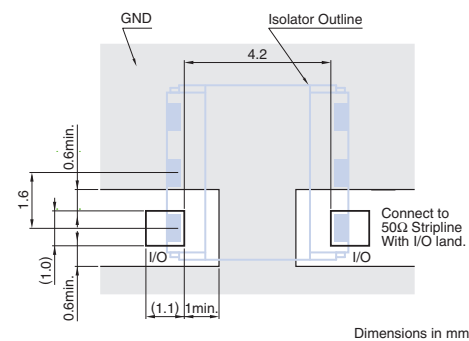

## PACKAGE QUANTITY

Standard package quantity	1000 pieces/reel
---------------------------	------------------

Please be sure to request delivery specifications that provide further details on the features and specifications of the products for proper and safe use.  
 Please note that the contents may change without any prior notice due to reasons such as upgrading.

## REMINDERS FOR USING THESE PRODUCTS

Before using these products, be sure to request the delivery specifications.

### SAFETY REMINDERS

Please pay sufficient attention to the warnings for safe designing when using these products.

#### REMINDERS

Please do not bring the magnet close to the product (Recommending is separating to 50cm or more). An electric characteristic might be deteriorated.

The magnetic field of 5mT or more must not go into the product when you make the magnet approach.

Moreover, please do not touch a soft magnetic material such as iron (Recommending is separating to 10mm or more). An electric characteristic might be deteriorated. An electric characteristic changes when bringing it close within 10mm(reversible change).

There is a leakage of some magnetism (0.3T or less) from the product.

The products listed on this catalog are intended for use in general electronic equipment (AV equipment, telecommunications equipment, home appliances, amusement equipment, computer equipment, personal equipment, office equipment, measurement equipment, industrial robots) under a normal operation and use condition.

The products are not designed or warranted to meet the requirements of the applications listed below, whose performance and/or quality require a more stringent level of safety or reliability, or whose failure, malfunction or trouble could cause serious damage to society, person or property.

Please understand that we are not responsible for any damage or liability caused by use of the products in any of the applications below or for any other use exceeding the range or conditions set forth in this catalog.

- |   |  |
|---|--|
| (1) Aerospace/Aviation equipment                                  | (8) Public information-processing equipment                                  |
| (2) Transportation equipment (cars, electric trains, ships, etc.) | (9) Military equipment   |
| (3) Medical equipment   | (10) Electric heating apparatus, burning equipment                           |
| (4) Power-generation control equipment                            | (11) Disaster prevention/crime prevention equipment                          |
| (5) Atomic energy-related equipment                               | (12) Safety equipment  |
| (6) Seabed equipment  | (13) Other applications that are not considered general-purpose applications |
| (7) Transportation control equipment                              |  |

When using this product in general-purpose applications, you are kindly requested to take into consideration securing protection circuit/equipment or providing backup circuits, etc., to ensure higher safety.