

May.1.2023 Copyright 2023 HIROSE ELECTRIC CO., LTD. All Rights Reserved.
 In case of consideration for using Automotive equipment / device which demand high reliability, kindly contact our sales window correspondents.

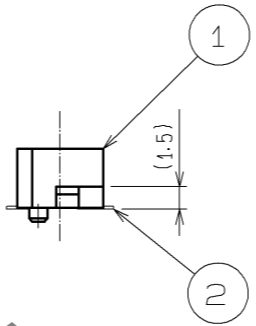

A-A (10:1)

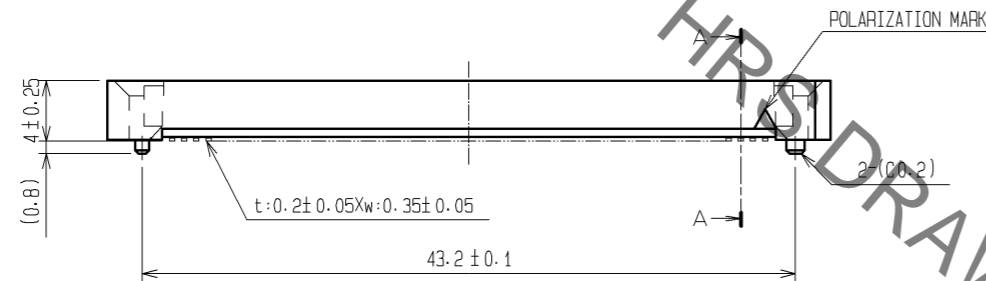
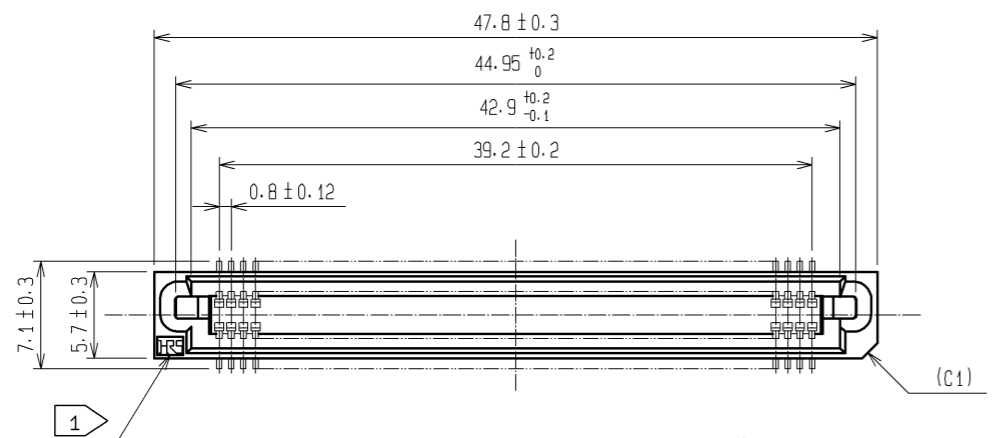
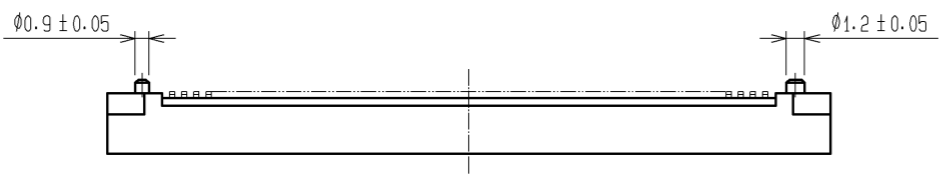
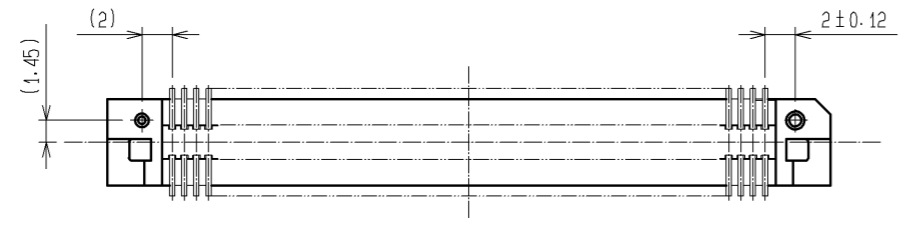
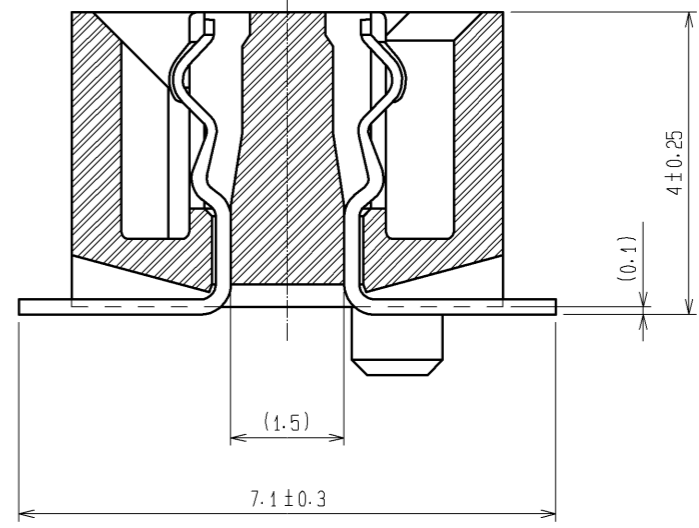

RECOMMENDED LAND PATTERN DIMENSION OF PCB (MOUNTING SIDE)
 (METAL MASK THICKNESS: t=0.15)

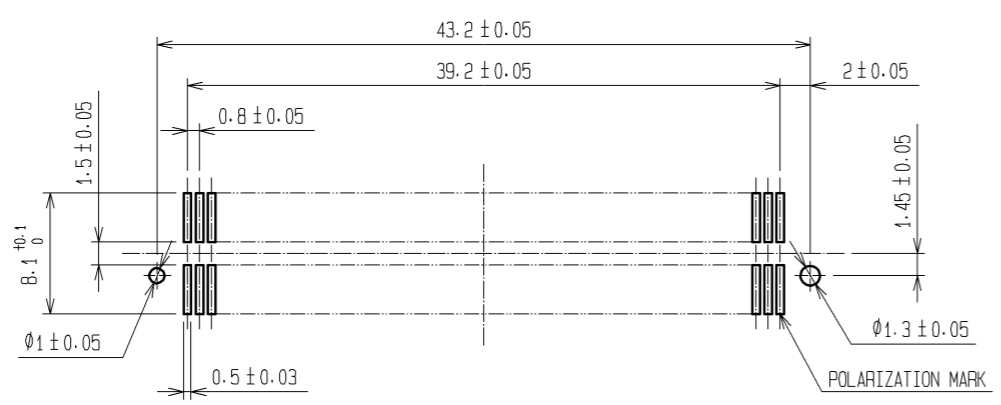

HRS DRAWING FOR REFERENCE

- NOTE
- 1 HRS MARK SHALL BE OPTIONAL.
 - 2 LEAD CO-PLANARITY SHALL BE 0.1mm MAX.
 - 3 FOR MODIFICATION, ETC., PREVENTIVE HOLE FOR SINK MARK MAY BE ADDED ACCORDING TO CIRCUMSTANCES.
 - 4 THE DIMENSIONS IN PARENTHESES ARE FOR REFERENCE.

1	PPS	LIGHT BROWN (UL94V-0)	2	PHOSPHOR BRONZE	CONTACT AREA : GOLD 0.1µm min. LEAD AREA : TIN-PLATING 1µm min. UNDER PLATING : NICKEL 2µm min.		
NO.	MATERIAL	FINISH . REMARKS	NO.	MATERIAL	FINISH . REMARKS		
UNITS mm		SCALE 2 : 1	COUNT 	DESCRIPTION OF REVISIONS	DESIGNED	CHECKED	DATE
HRS HIROSE ELECTRIC CO., LTD.		APPROVED : HS. OKAWA	08.06.16	DRAWING NO. EDC3-084985-25			
		CHECED : HT. YAMAGUCHI	08.06.16	PART NO. FX6-100S-0.8SV(71)			
		DESIGNED : TS. MIYAKI	08.06.16	CODE NO. CL576-0108-7-71			
		DRAWN : TS. MIYAKI	08.06.16			1/1	