

GENERAL DESCRIPTION

This document describes the specifications for the IDTF1178 Zero-Distortion™ RF to IF Downconverting Dual Mixer. This device is part of a series of mixers offered with high side and/or low side injection options for all UTRA bands. See the Part# Matrix for pin compatible & feature compatible devices in this series.

The F1178 dual channel device is designed to operate with a single 5V supply. It is optimized for operation in a Multi-mode, Multi-carrier BaseStation Receiver for RF bands from 3400MHz - 3800MHz with Low Side LO injection. IF frequencies from 30MHz to 550MHz are supported. Nominally, the device offers +37.5dBm Output IP3 with 297mA of I_{CC} .

COMPETITIVE ADVANTAGE

In typical basestation receivers, the RF to IF mixer dominates the linearity performance for the entire receive system. The Zero-Distortion™ family of mixers dramatically improves the maximum signal levels (IM_3 tones) that the BTS can withstand at a desired Signal to Noise Ratio (SNR). Zero-Distortion™ technology allows realization of either benefit.

- ✓ $IP3_0$: ↑ **9dB**
- ✓ Dissipation: ↓ **23%**
- ✓ Noise Figure: 8.5dB



PART# MATRIX

Part#	RF freq range (MHz)	UTRA bands	IF freq range (MHz)	Typ. Gain (dB)	Injection
F1100	698 - 915	5,6,8,12,13,14,17,19,20	150 - 450	9.0	High Side
F1102	400 - 1000	5,6,8,12,13,14,17,19,20	50 - 300	9.0	Both
F1150	1700 - 2200	1,2,3,4,9,10,33,34,35,36,37,39	50 - 450	8.5	High Side
F1152	1400 - 2200	1,2,3,4,9,10,11 ¹ ,21 ¹ ,24 ¹ ,33,34,35,36,37,39	50 - 350	8.5	Low Side
F1162	2300 - 2700	7,38,40,41	50 - 500	8.9	Both
F1178	3400 - 3800	22, 42, 43	30 - 550	9.0	Low Side

1 – with High Side injection

FEATURES

- Dual Path for Diversity Systems
- Ideal for Multi-Carrier Systems
- 9dB Gain
- Ultra linear **+37.5dBm $IP3_0$**
- 8.5dB NF
- 200 Ω output impedance
- High +11dBm $P1dB_I$
- **Pin & Feature Compatible**
- 6mm x 6mm, 36-pin package
- **Individual Path Standby Mode**
- <400 nsec settling from Power Up
- $I_{CC} = 297mA$

DEVICE BLOCK DIAGRAM

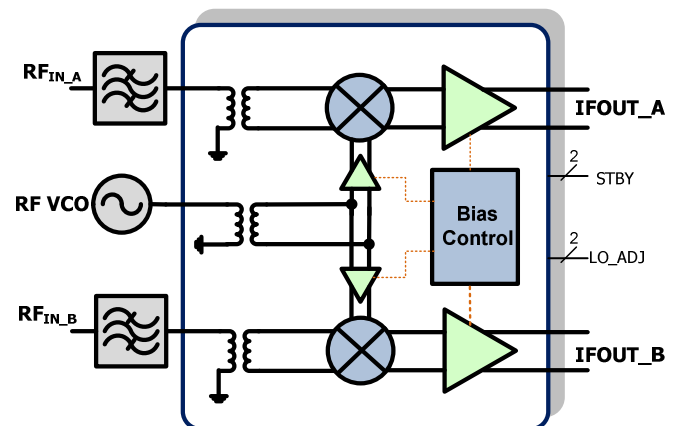

ORDERING INFORMATION

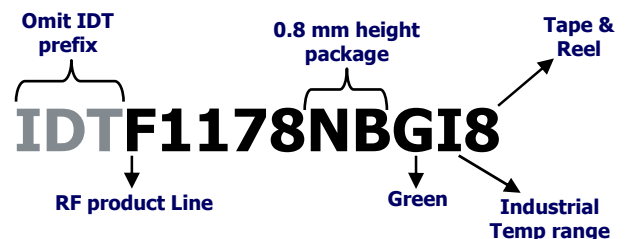

ABSOLUTE MAXIMUM RATINGS

Parameter / Condition	Symbol	Min	Max	Unit
VCC to GND	VCC	-0.3	+5.5	V
STBY1, STBY2	V_{STBY1}, V_{STBY2}	-0.3	VCC + 0.3	V
IF_A+, IF_B+, IF_A-, IF_B-	$V_{IF_A+}, V_{IF_B+}, V_{IF_A-}, V_{IF_B-}$	+1.0	VCC+ 0.3	V
LO1_ADJ	V_{LO1_ADJ}	+1.0	3.0	V
LO2_ADJ	V_{LO2_ADJ}	+2.1	4.0	V
LO_IN, RF_A, RF_B	$V_{LO_IN}, V_{RF_A}, V_{RF_B}$	-0.3	+0.3	V
IF_BiasA, IF_BiasB to GND	$V_{IF_BiasA}, V_{IF_BiasB}$	-0.3	+0.3	V
RF Input Power	$P_{LO_IN}, P_{RF_A}, P_{RF_B}$		+20	dBm
Continuous Power Dissipation			2.2	W
Operating Temperature Range (Case Temperature)	T_C	-40	+105	°C
Maximum Junction Temperature	T_{Jmax}		150	°C
Storage Temperature Range	T_{ST}	-65	+150	°C
Lead Temperature (soldering, 10s)	T_{LEAD}		+260°	°C
ESD Voltage– HBM (Per JESD22-A114)	V_{ESDHBM}		Class 2 (2500V)	
ESD Voltage – CDM (Per JESD22-C101)	V_{ESDCDM}		Class C3 (1000V)	

Stresses above those listed above may cause permanent damage to the device. Functional operation of the device at these or any other conditions above those indicated in the operational section of this specification is not implied. Exposure to absolute maximum rating conditions for extended periods may affect device reliability.

PACKAGE THERMAL AND MOISTURE CHARACTERISTICS

θ_{JA} (Junction – Ambient)	35°C/W
θ_{JC} (Junction – Case) The Case is defined as the exposed paddle	2.5°C/W
Moisture Sensitivity Rating (Per J-STD-020)	MSL 1

IDTF1178 RECOMMENDED OPERATING CONDITIONS

Parameter	Symbol	Comment	min	typ	max	Units
Supply Voltage(s)	V_{CC}	All V_{CC} pins	4.75		5.25	V
LO Power	P_{LO}		-3		+3	dBm
Operating Temperature Range	T_{CASE}	Case Temperature	-40		+105	deg°C
RF Freq Range	F_{RF}		3400		3800	MHz
LO Freq Range	F_{LO}		2900		3620	
IF Freq Range	F_{IF}		30		550	

The F1178 is well suited for DPD applications with a broad IF frequency range from 30 MHz to 550 MHz using the standard BOM specified in this datasheet

IDTF1178 SPECIFICATION

Typical Application Circuit specifications apply at $V_{CC} = +5.00V$, $T_C = +25^\circ C$ using LS LO. $F_{RF} = 3550$ MHz, $F_{LO} = 3250$ MHz, $F_{IF} = 300$ MHz, $P_{in} = -10$ dBm/tone unless otherwise stated, $P_{LO} = 0$ dBm, STBY = GND, Transformer Loss not included (de-embedded), RF trace de-embedded unless otherwise noted.

Parameter	Symbol	Comment	min	typ	max	units
Logic Input High ³	V_{IH}	For Standby Pins	1.1			V
Logic Input Low ³	V_{IL}	For Standby Pins			0.60	V
Logic Current	I_{IH}, I_{IL}	For Standby Pins	-110		+5	μA
Supply Current	I_{2CHAN}	Total Both Channels		297	345¹	mA
	I_{1CHAN}	Single Channel		155	180	
	I_{STBY}	<ul style="list-style-type: none"> ▪ STBY = V_{IH} ▪ Total Both Channels 		14	24	
Power Up Time	T_{ON}	<ul style="list-style-type: none"> • Pin = -13 dBm • Gate STBY from V_{IH} to V_{IL} • Time for IF Signal to settle to within 0.1 dB of final value 		0.38		μsec
Power Down Time	T_{OFF}	<ul style="list-style-type: none"> • Pin = -13 dBm • Gate STBY from V_{IL} to V_{IH} Time for IF Signal to settle to within 0.1 dB of final value 		0.155		μsec
Conversion Gain	G		7.8	9	10	dB
Gain, Temperature drift	G_{DRIFT}	Tcase: $-40^\circ C$ to $+105^\circ C$		0.015		dB/ $^\circ C$
Noise Figure	NF			8.5		dB
Noise Figure - HOT	NF_{HOT}	Tcase = $105^\circ C$		10.3		dB
Noise Figure, Temperature drift	NF_{DRIFT}	Tcase: $-40^\circ C$ to $+105^\circ C$		0.022		dB/ $^\circ C$
Noise Figure w/Blocker	NF_{BLK}	<ul style="list-style-type: none"> ▪ +100MHz offset blocker ▪ $P_{IN} = +8$ dBm 		18.5		dB
Output IP3	$IP3_O$	5MHz Tone Separation	33	37.5		dBm
2RF – 2LO rejection	2x2	<ul style="list-style-type: none"> ▪ $P_{RF} = -10$ dBm ▪ Frequency = $F_{RF} - \frac{1}{2} F_{IF}$ 		-64	-54	dBc
3RF – 3LO rejection	3x3	<ul style="list-style-type: none"> ▪ $P_{RF} = -10$ dBm ▪ Frequency = $F_{RF} - \frac{1}{3} F_{IF}$ 		-75	-65	dBc
1 dB Compression	$P1dB_I$	Input referred	9	11		dBm

IDTF1178 SPECIFICATION (CONTINUED)

Typical Application Circuit specifications apply at $V_{CC} = +5.00V$, $T_C = +25^{\circ}C$ using LS LO. $F_{RF} = 3550$ MHz, $F_{LO} = 3250$ MHz, $F_{IF} = 300$ MHz, $P_{in} = -10$ dBm/tone unless otherwise stated, $P_{LO} = 0$ dBm, STBY = GND, Transformer Loss not included (de-embedded), RF trace de-embedded unless otherwise noted.

Parameter	Symbol	Comment	min	typ	max	units
RF Input Impedance	Z_{RF}	Single Ended		50		Ω
RF Input Return Loss	RL_{RF}	No external matching		18		dB
IF Output Impedance	Z_{IF}	Differential		200		Ω
IF Output Return Loss	RL_{IF}	No external matching		13		dB
LO Port Impedance	Z_{LO}	Single Ended		50		Ω
LO Port Return Loss	LO_{RF}	No external matching		14		dB
Channel Isolation	ISO_C	IF_B Pout vs. IF_A w/ RF_A input	40	44		dB
LO to IF leakage	ISO_{LI}			-30	-25	dBm
RF to IF leakage	ISO_{RI}	Relative to IF Pout		-50	-40	dBc
LO to RF leakage	ISO_{LR}			-30		dBm

1 – Items in min/max columns in ***bold italics*** are Guaranteed by Test

2 – All other Items in min/max columns are Guaranteed by Design Characterization

3 – JEDEC 1.8V logic

STANDBY LOGIC TABLE

Main Channel	Diversity Channel	STBY1 (pin 22)	STBY2 (pin 24)
ON	ON	0	0
OFF	OFF	1	0
ON	OFF	0	1
OFF	ON	1	1

TYPICAL OPERATING CONDITIONS

Unless otherwise noted, the following conditions apply to the Typ Ops Graphs:

- 5MHz Tone Spacing
- Low Side LO injection graphs with 300MHz & 400MHz & 500MHz IF
- Pin = - 10 dBm per Tone
- LO port = Pin 19 (Main Port)
- Listed Temperatures are Case Temperature (TC = Case Temperature)
- Where noted, TA or TAMB = Ambient Temperature

TYPICAL OPERATION CONDITIONS [IF = 300MHz, LOW SIDE INJECTION] (-1-)

Gain vs. T_{CASE}

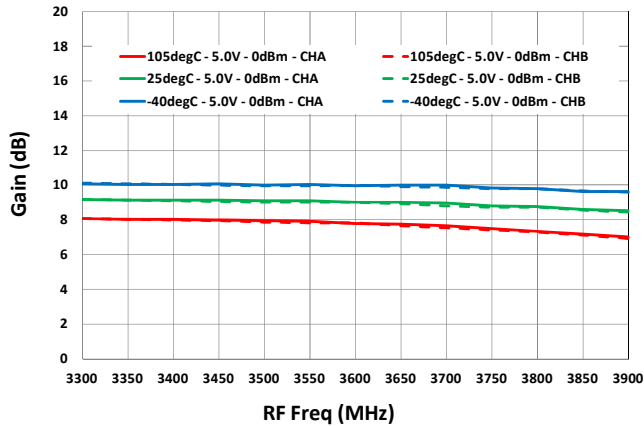

Gain vs. V_{cc}

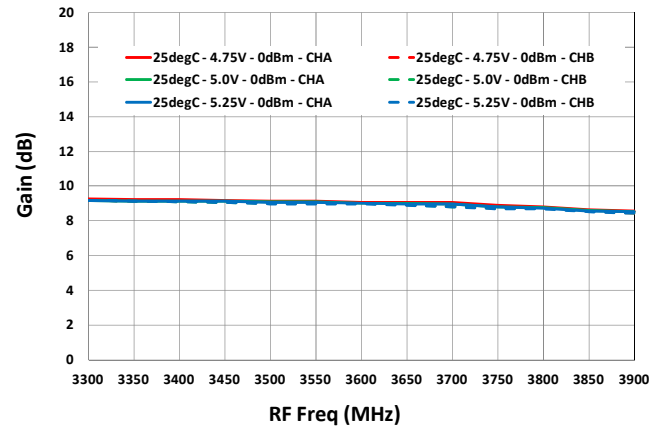

Gain vs. Lo Level

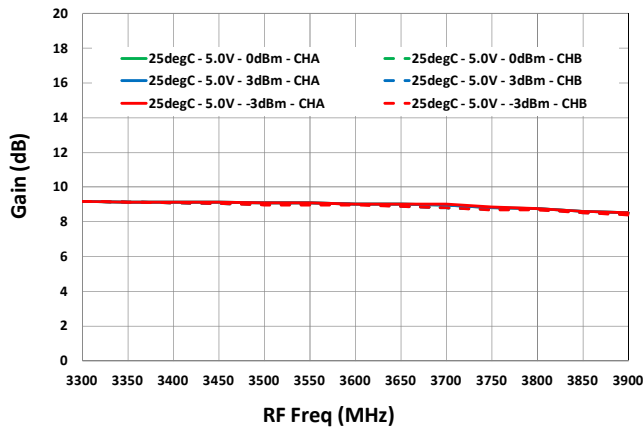

Output IP3 vs. T_{CASE}

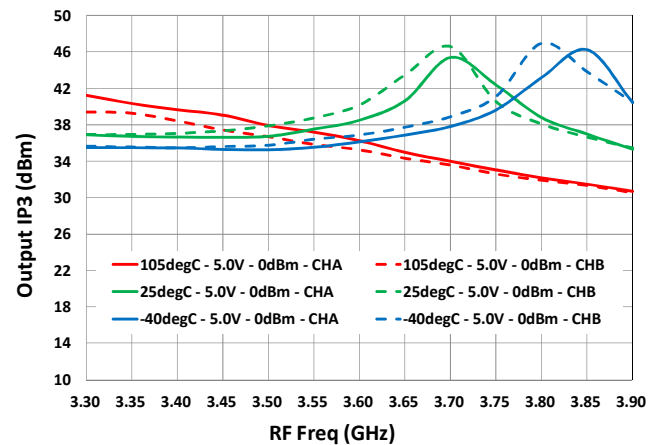

Output IP3 vs. V_{cc}

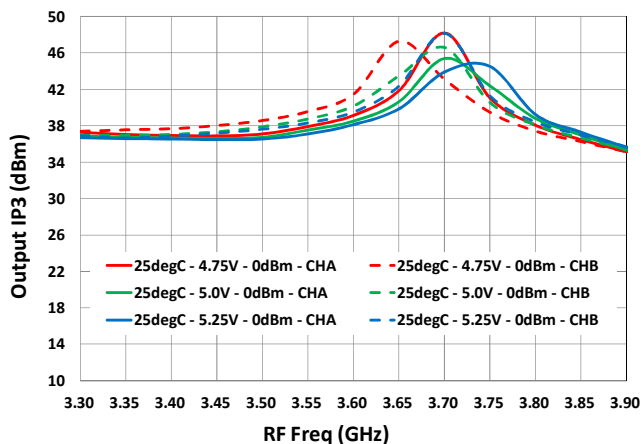

Output IP3 vs. LO Level

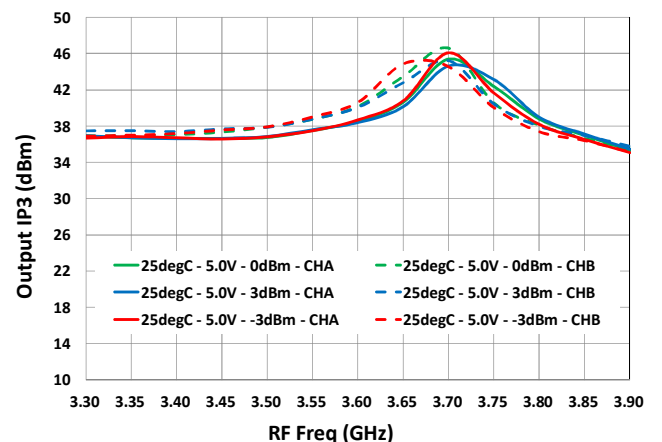

TYPICAL OPERATION CONDITIONS [IF = 300MHz, LOW SIDE INJECTION] (-2-)

2RF x 2LO rejection vs. T_{CASE}

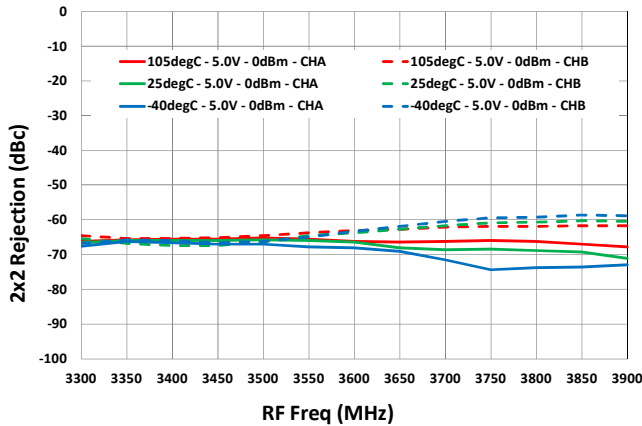

2RF x 2LO Rejection vs. LO Level

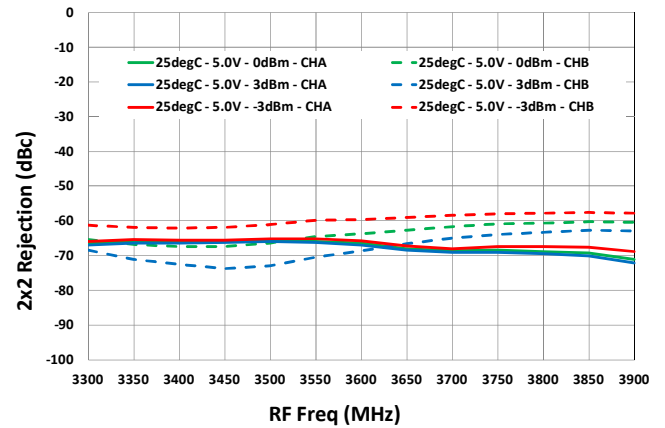

2RF x 2LO Rejection vs. V_{CC}

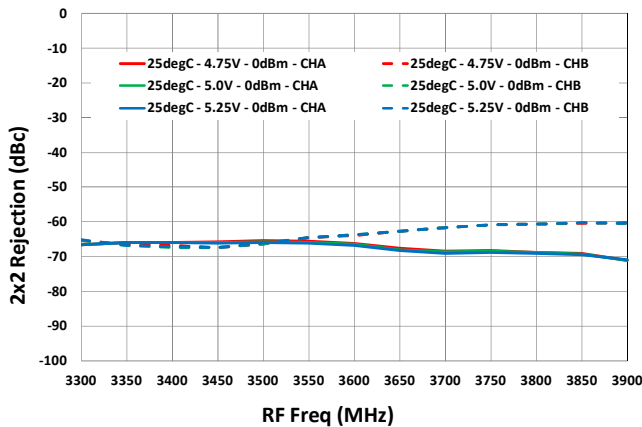

3RF x 3LO rejection vs. T_{CASE}

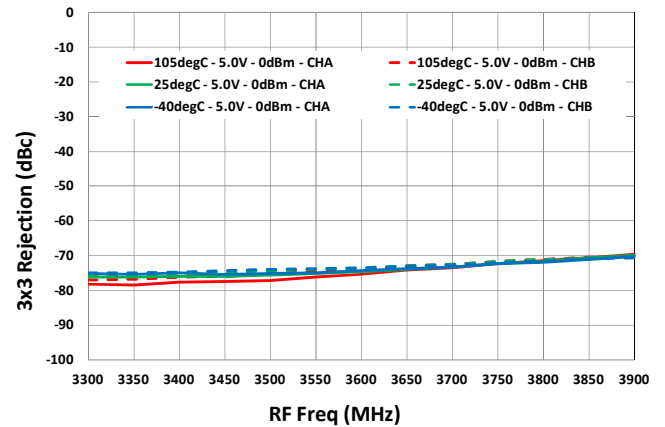

3RF x 3LO Rejection vs. LO Level

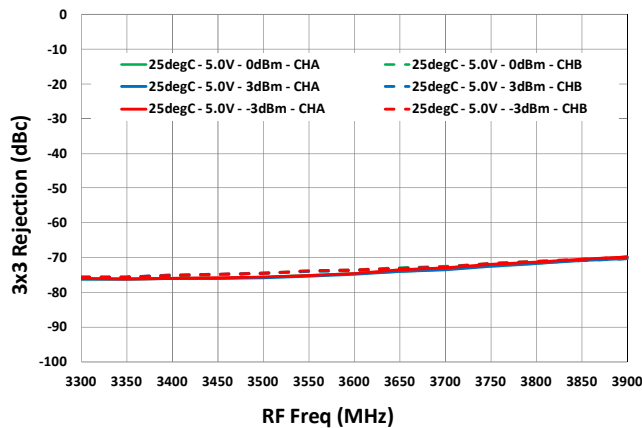

3RF x 3LO Rejection vs. V_{CC}

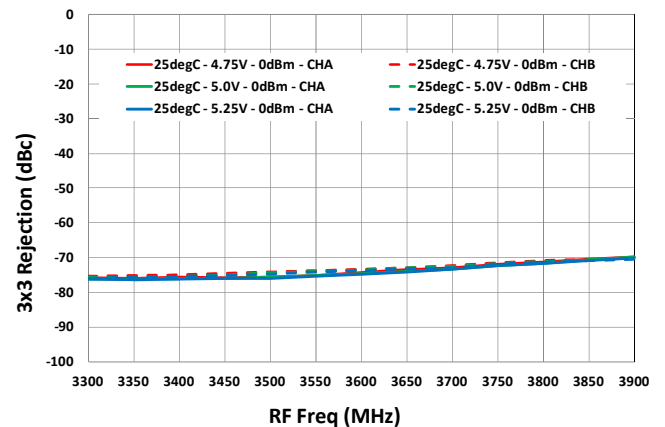

TYPICAL OPERATION CONDITIONS [IF = 300MHz, LOW SIDE INJECTION] (-3-)

2nd Harmonic vs. T_{CASE}

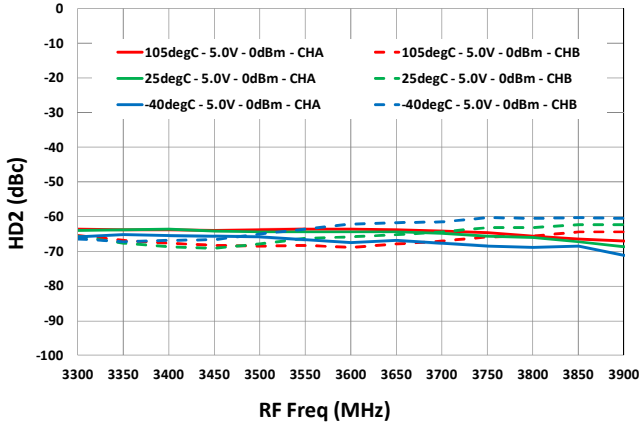

2nd Harmonic vs. LO Level

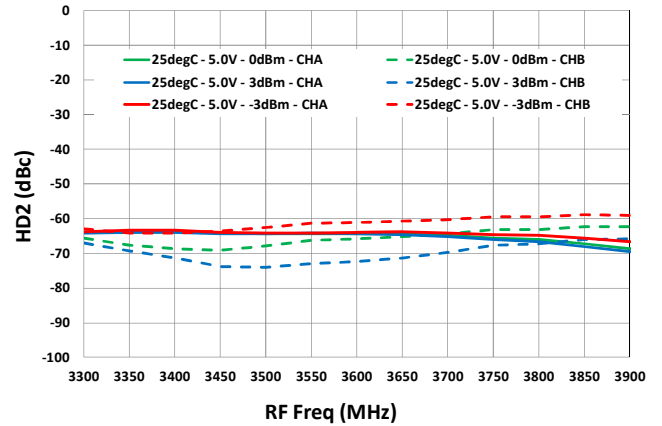

2nd Harmonic vs. V_{CC}

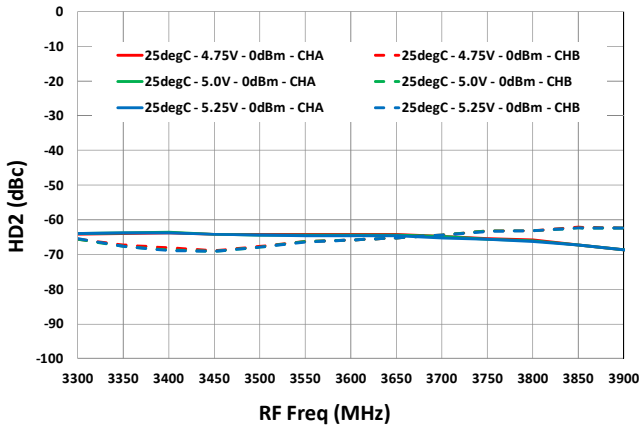

3rd Harmonic vs. T_{CASE}

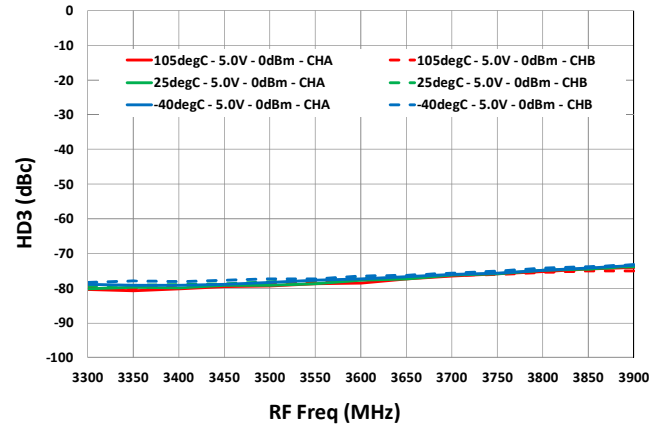

3rd Harmonic vs. Lo Level

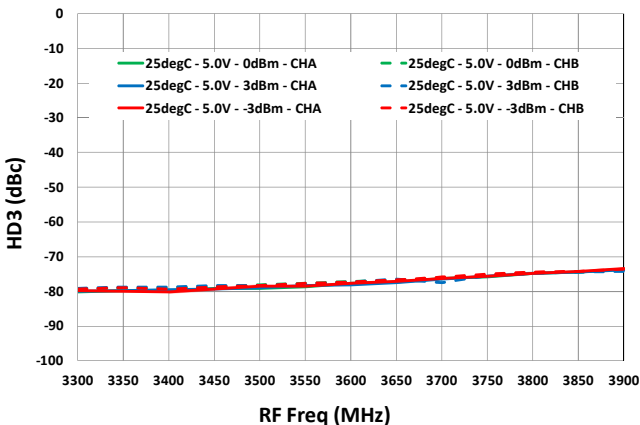

3rd Harmonic vs. V_{CC}

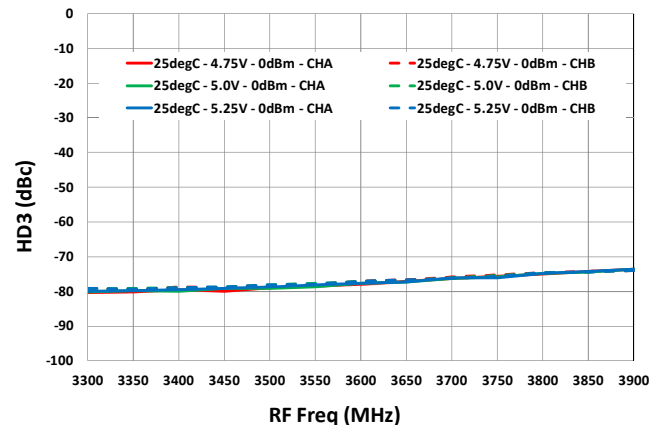

TYPICAL OPERATION CONDITIONS [IF = 300MHz, LOW SIDE INJECTION] (-4-)

LO-IF Leakage vs. T_{CASE}

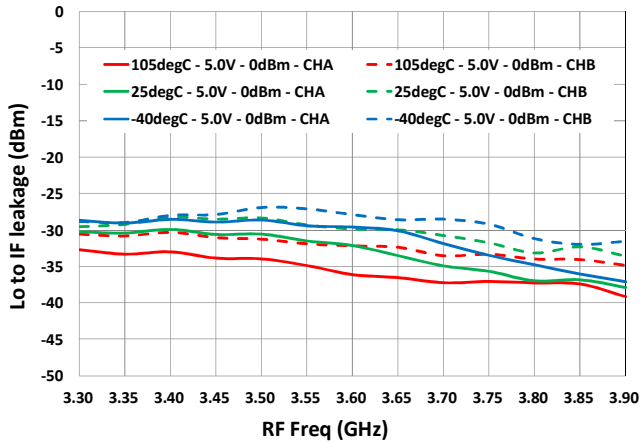

LO-IF Leakage vs. LO Level

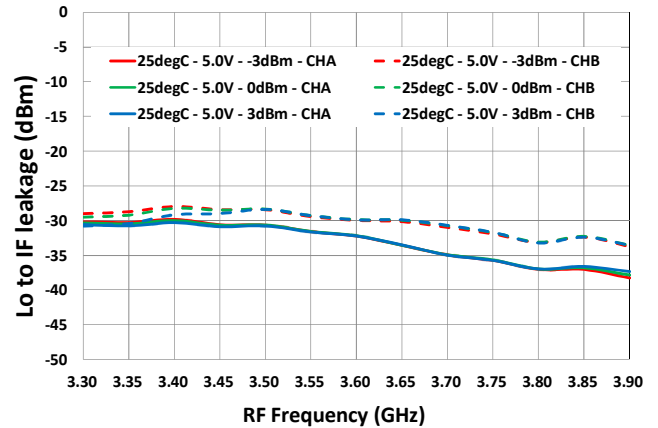

LO-IF Leakage vs. V_{CC}

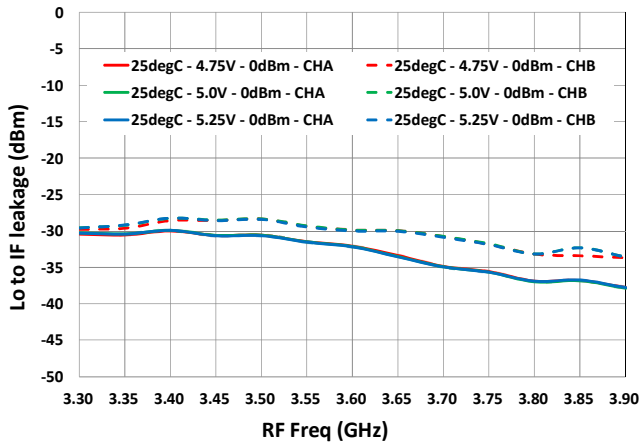

RF-IF Leakage vs. T_{CASE}

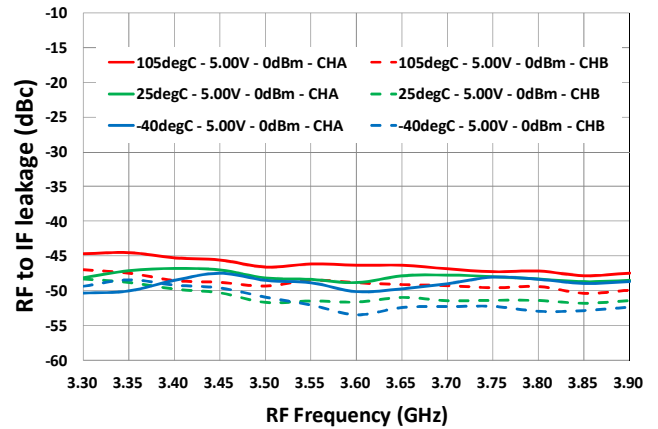

RF-IF Leakage vs. LO Level

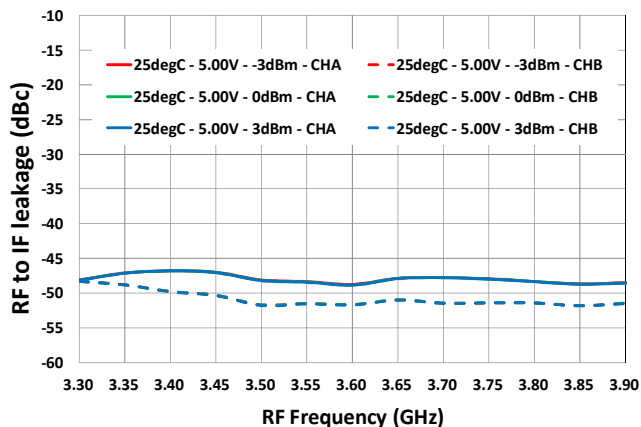

RF-IF Leakage vs. V_{CC}

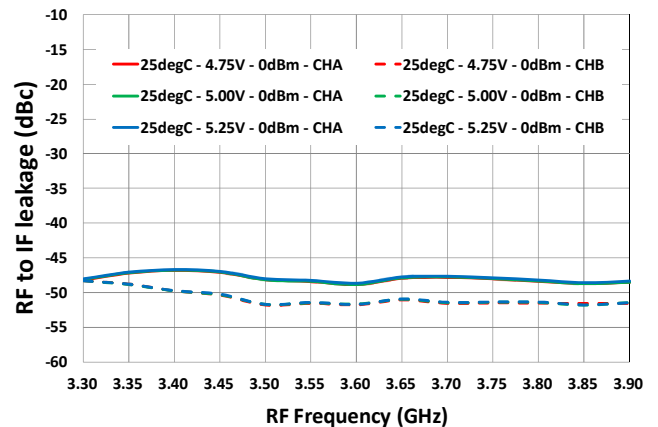

TYPICAL OPERATION CONDITIONS [IF = 300MHz, LOW SIDE INJECTION] (-5-)

Lo-RF Leakage vs. T_{CASE}

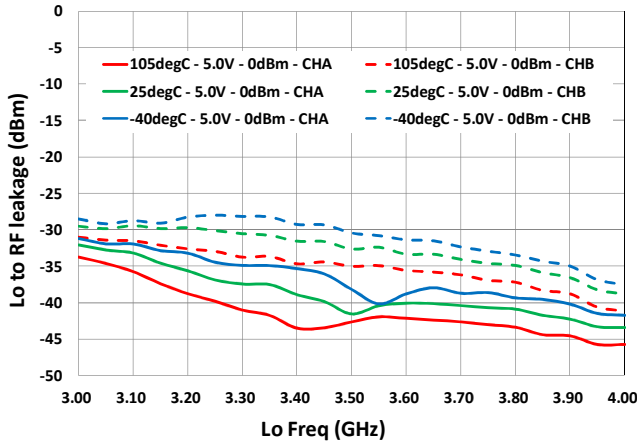

Lo-RF Leakage vs. LO Level

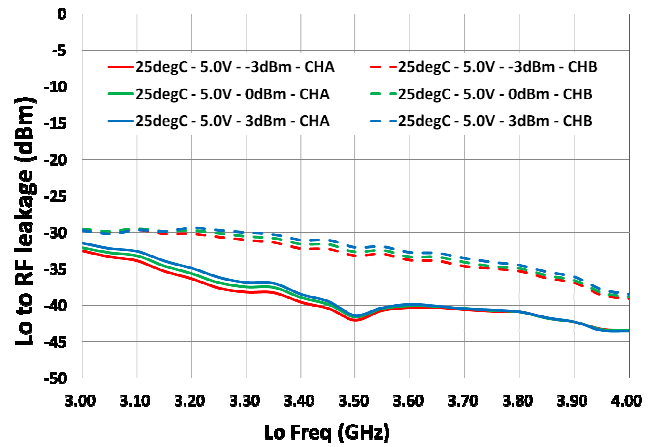

Lo-RF Leakage vs. V_{CC}

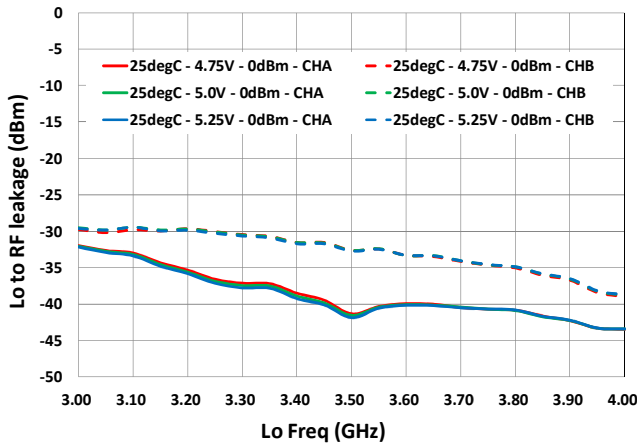

I_{CC} vs. T_{CASE}

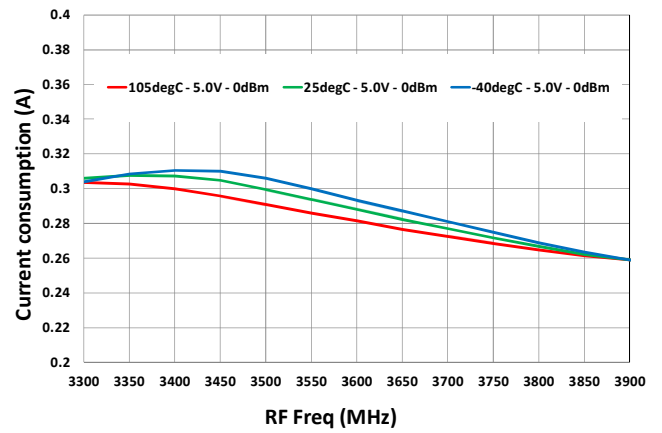

I_{CC} vs. V_{CC}

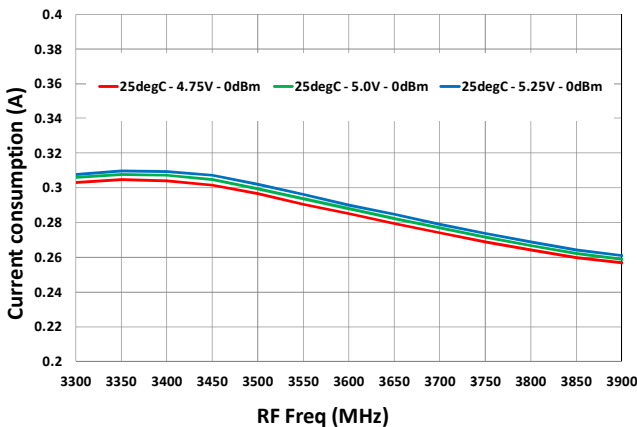

I_{CC} vs. LO Level

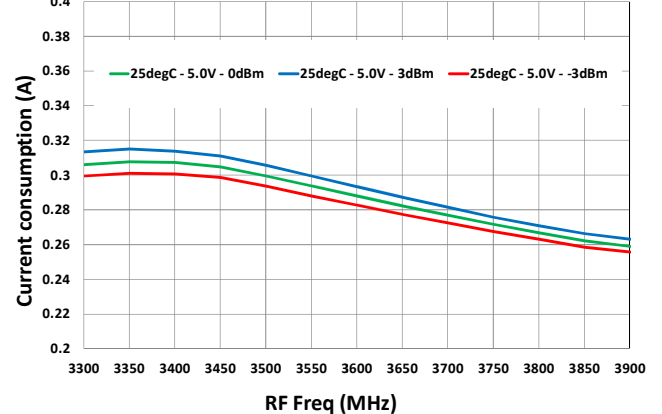

TYPICAL OPERATION CONDITIONS [IF = 300MHz, LOW SIDE INJECTION] (-6-)

Channel Isolation vs. T_{CASE}

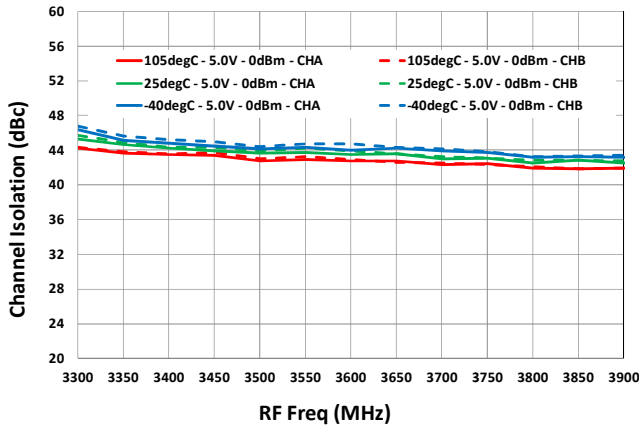

Channel Isolation vs. LO Level

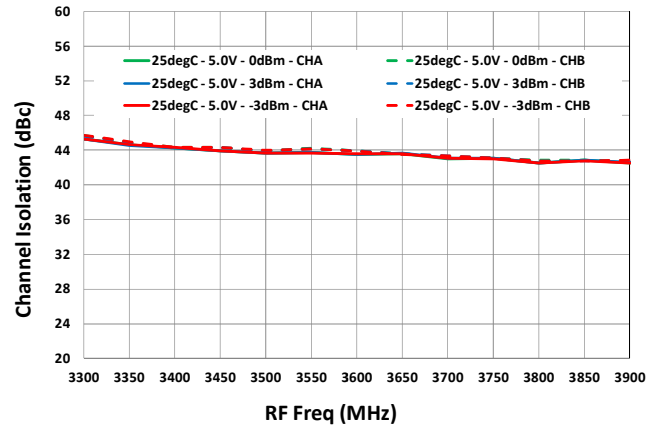

Channel Isolation vs. V_{CC}

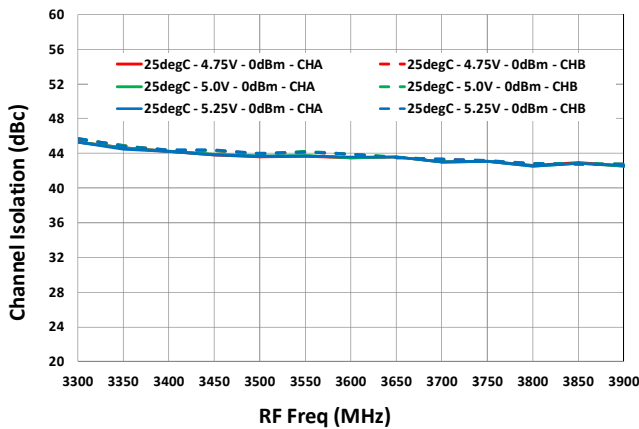

INPUT P1dB

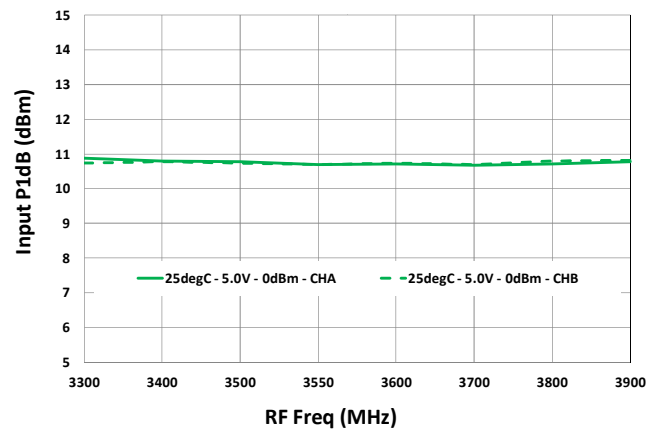

Settling Time (STBY -> V_{IL})

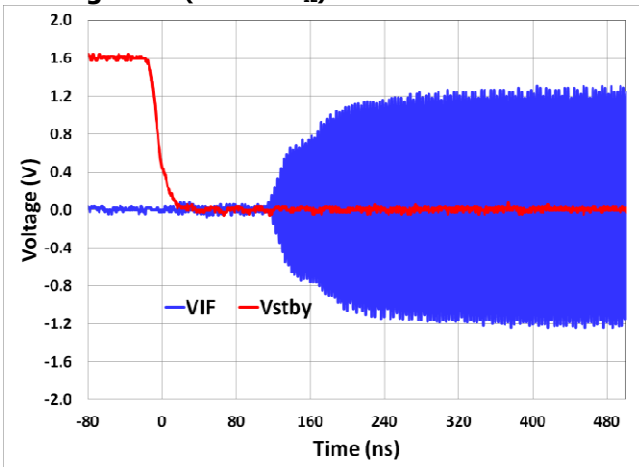

Settling Time (STBY -> V_{IH})

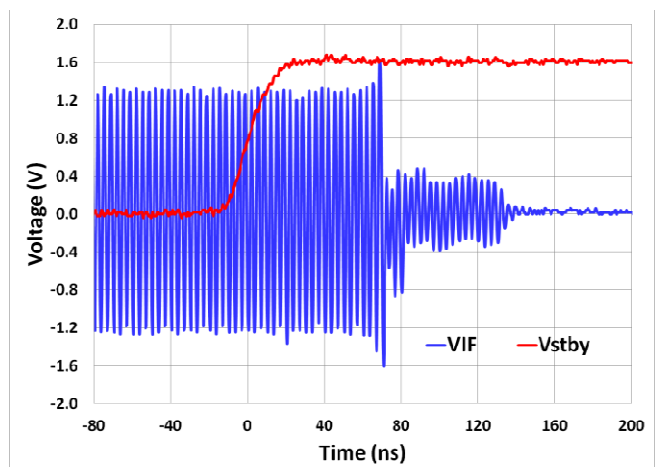

TYPICAL OPERATION CONDITIONS [IF = 300MHz, LOW SIDE INJECTION] (-7-)

NOISE FIGURE [RF: 3550MHz]

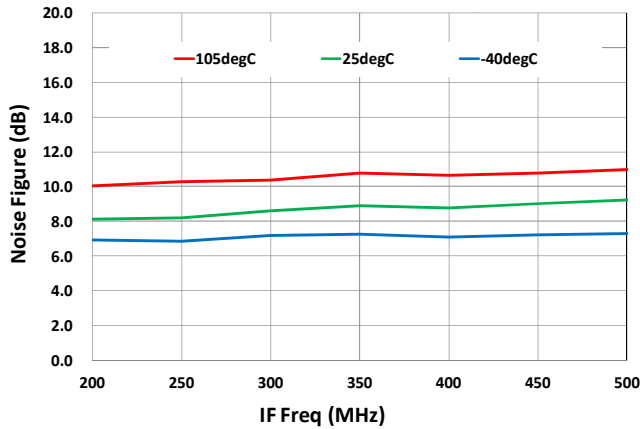

NOISE FIGURE w/ BLOCKER 100MHz OFFSET [RF: 3550MHz]

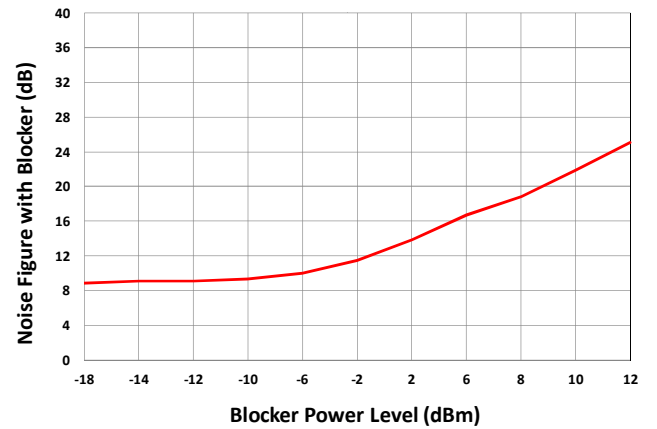

LO PORT RETURN LOSS

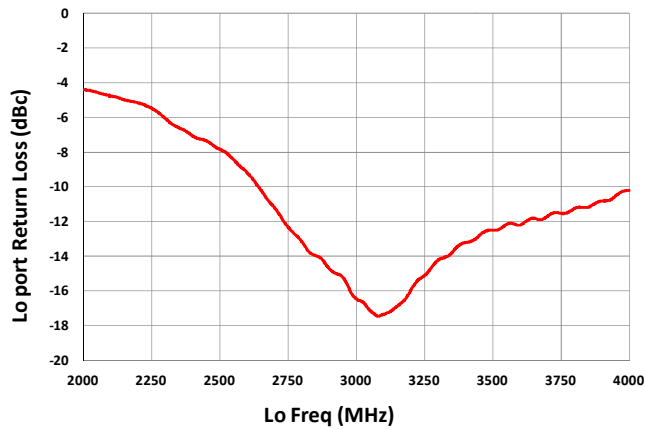

RF PORT RETURN LOSS

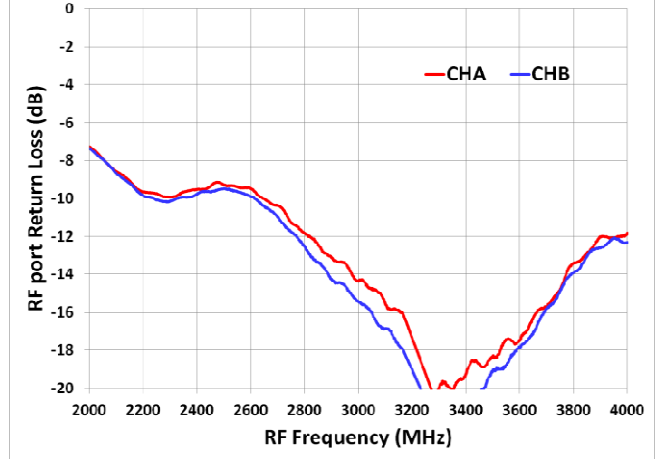

IF PORT RETURN LOSS

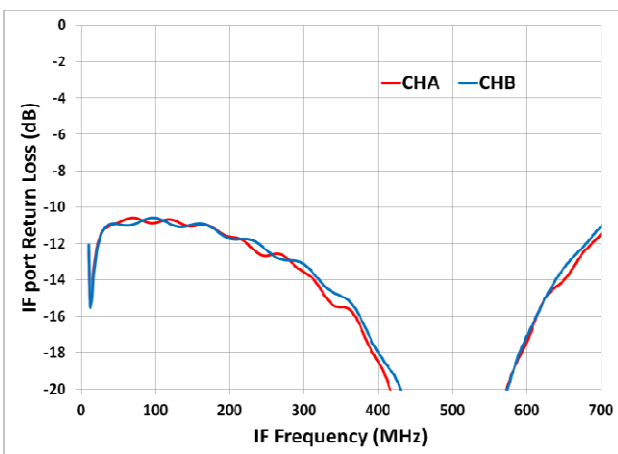

PACKAGE DRAWING (6X6 QFN)

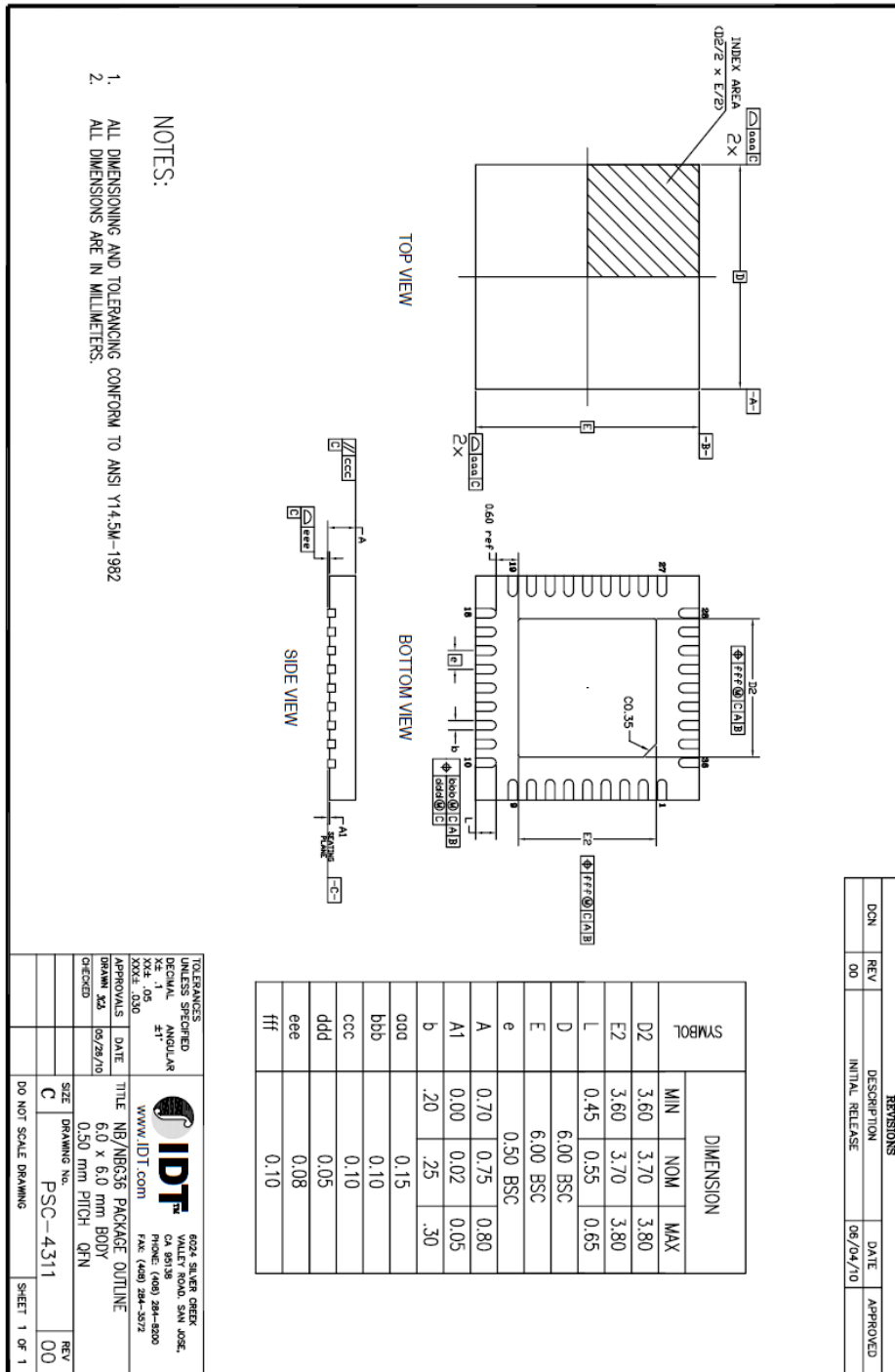

REVISIONS			
DEN	REV	DESCRIPTION	DATE
	00	INITIAL RELEASE	06/04/10
			APPROVED

TOLERANCES UNLESS SPECIFIED:
 DECIMAL ANGULAR ±1°
 XX.X .05
 XXX.X .030

APPROVALS:
 DRAWN X2 05/29/10
 CHECKED

SIZE C
 DRAWING No. PSC-4311
 DO NOT SCALE DRAWING

REVISIONS: 00

SHEET 1 OF 1

IDT
 www.IDT.com
 6024 SILVER CREEK VALLEY ROAD, SUITE 400E, CA 95138
 PHONE: (408) 284-8500 FAX: (408) 284-5572

TITLE: NB/NB6356 PACKAGE OUTLINE
 6.0 x 6.0 mm BODY
 0.50 mm PITCH QFN

F1178 PINOUT

Signal Path Inputs & Outputs in **BLUE**

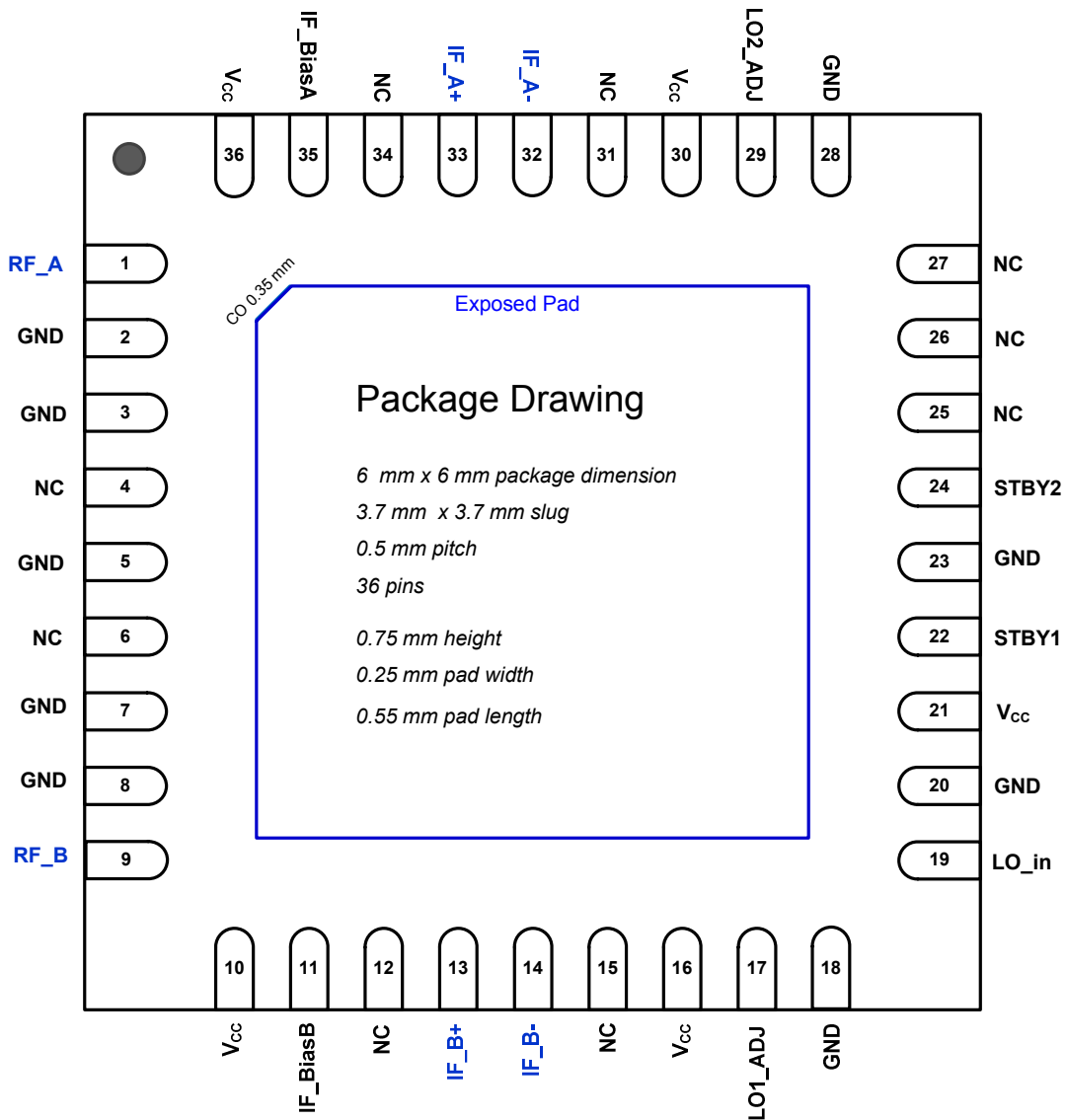

PIN DESCRIPTION TABLE

Pin	Name	Function
1	RF_A	Main Channel RF Input. Internally matched to 50Ω. DO NOT apply DC to this pin. Place the coupling capacitor close as close to the pin as possible.
2, 3, 5, 7, 8, 18, 20, 23, 28	GND	Ground these pins.
4, 6, 12, 15, 25, 26, 27, 31, 34	N.C.	No Connection. Not internally connected. OK to connect to Vcc. OK to connect to GND.
10, 16, 21, 30, 36	VCC	Power Supply. Bypass to GND with capacitors shown in the Typical Application Circuit as close as possible to pin.
9	RF_B	Diversity Channel RF Input. Internally matched to 50Ω. DO NOT apply DC to this pin. Place the coupling capacitor close as close to the pin as possible.
11	IF_BiasB	Connect the specified resistor from this pin to ground to set the bias for the Diversity IF amplifier. This is NOT a current set resistor.
13, 14	IFB+, IFB-	Diversity Mixer Differential IF Output. Connect pullup inductors from each of these pins to VCC (see the Typical Application Circuit).
17	LO1_ADJ	Connect the specified resistor from this pin to ground to set the first stage LO common buffer Icc.
19	LO_in	Local Oscillator Input. Connect the LO to this port through the recommended coupling capacitor. DO NOT apply DC to this pin.
22	STBY1	STBY control pin 1. See STBY Logic Table for desired setting
24	STBY2	STBY control pin 2. See STBY Logic Table for desired setting
29	LO2_ADJ	Connect the specified resistor from this pin to ground to set the first stage LO common buffer Icc.
32, 33	IFA-, IFA+	Main Mixer Differential IF Output. Connect pullup inductors from each of these pins to VCC (see the Typical Application Circuit).
35	IF_BiasA	Connect the specified resistor from this pin to ground to set the bias for the Main IF amplifier. This is NOT a current set resistor.
	— EP	Exposed Pad. Internally connected to GND. Solder this exposed pad to a PCB pad that uses multiple ground vias to provide heat transfer out of the device into the PCB ground planes. These multiple via grounds are also required to achieve the noted RF performance.

DIGITAL PIN VOLTAGE & RESISTANCE VALUES

Pin	Name	DC voltage (volts)	Resistance (ohms)
22	STBY1	5	50K
24	STBY2	Floating voltage	Open Circuit

POWER SUPPLIES

A common VCC power supply should be used for all pins requiring DC power. All supply pins should be bypassed with external capacitors to minimize noise and fast transients. Supply noise can degrade noise figure and fast transients can trigger ESD clamps and cause them to fail. Supply voltage change or transients should have a slew rate smaller than 1V/20uS. In addition, all control pins should remain at 0V (+/-0.3V) while the supply voltage ramps or while it returns to zero.

EVKIT & TYPICAL APPLICATION SCHEMATIC

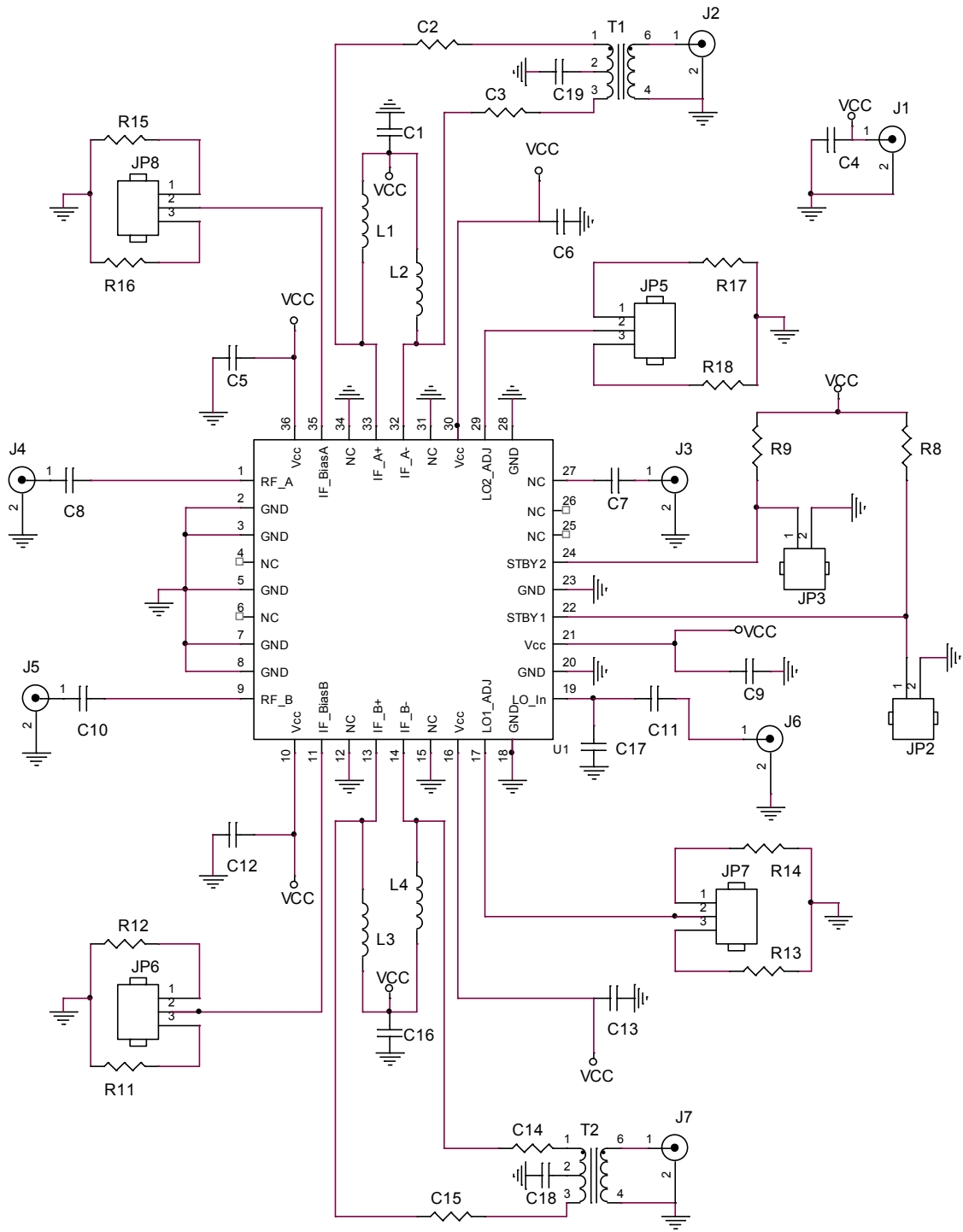

EVKIT PICTURE

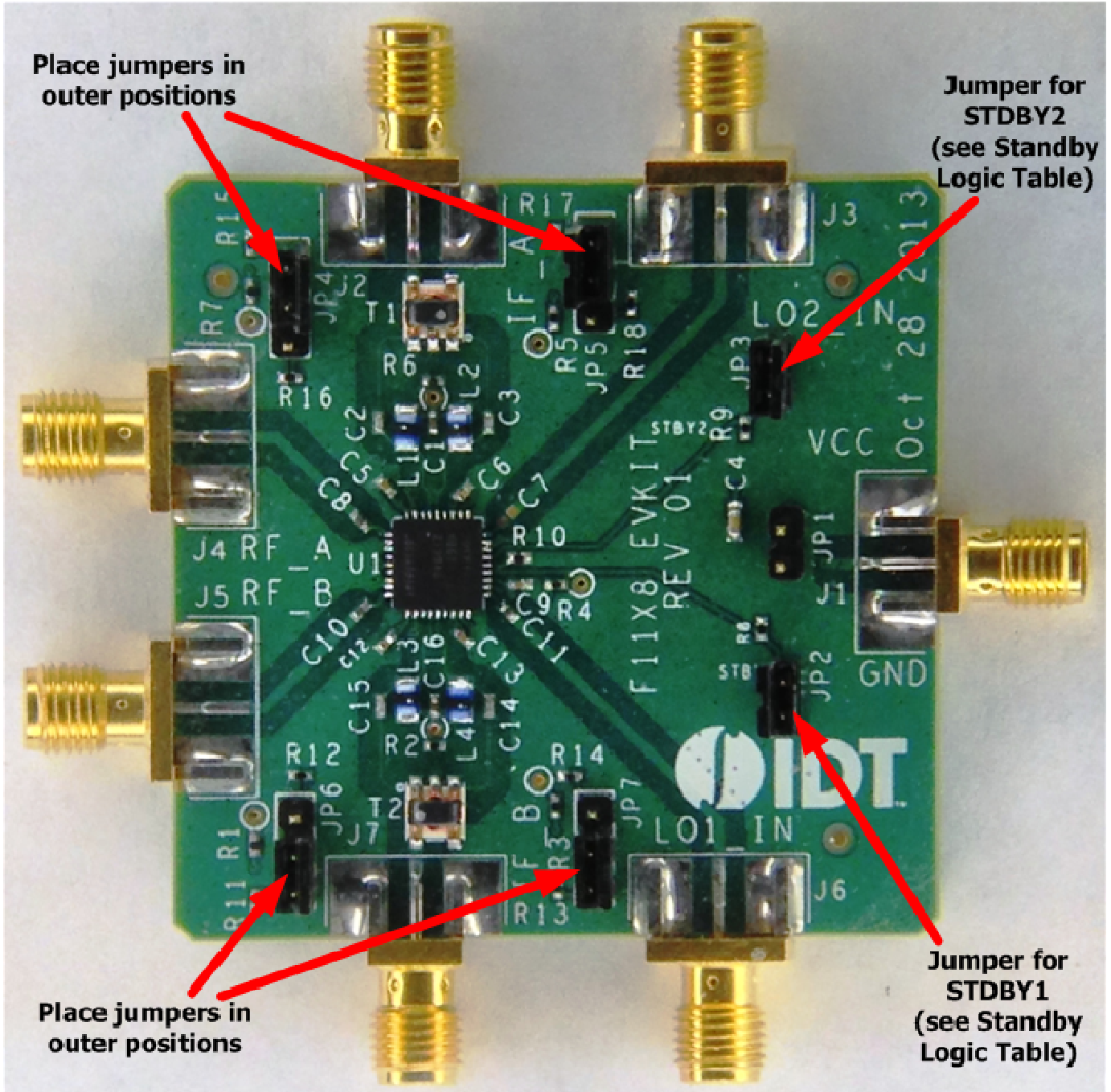

EVKIT BOM

Part Reference	QTY	DESCRIPTION	Mfr. Part #	Mfr.
C1, C5, C6, C9, C12, C13, C16	7	10000pF ±10%, 16V, X7R Ceramic Capacitor (0402)	GRM155R71C103K	Murata
C8, C10, C11	3	39pF ±5%, 50V, C0G Ceramic Capacitor (0402)	GRM1555C1H390J	Murata
C17	1	0.3pF ±0.05pF, 50V, C0G Ceramic Capacitor (0402)	GRM1555C1HR30W	Murata
C18, C19	2	1000pF ±5%, 50V, C0G Ceramic Capacitor (0402)	GRM1555C1H102J	Murata
C4	1	10uF ±20%, 6.3V, X5R Ceramic Capacitor (0603)	GRM188R60J106M	Murata
R1-R7, R10	8	0Ω 1/10W Resistors (0402)	ERJ-2GE0R00X	Panasonic
C2, C3, C14, C15	4	10Ω ±1%, 1/10W, Resistor (0402)	ERJ-2RKF10R0X	Panasonic
R13	1	240Ω ±1%, 1/10W, Resistor (0402)	ERJ-2RKF2400X	Panasonic
R14	1	270Ω ±1%, 1/10W, Resistor (0402)	ERJ-2RKF2700X	Panasonic
R11, R12, R15, R16	4	330Ω ±1%, 1/10W, Resistor (0402)	ERJ-2RKF3300X	Panasonic
R17	1	2.4kΩ ±1%, 1/10W, Resistor (0402)	ERJ-2RKF2401X	Panasonic
R18	1	2.67kΩ ±1%, 1/10W, Resistor (0402)	ERJ-2RKF2671X	Panasonic
R8, R9	2	47kΩ ±1%, 1/10W, Resistor (0402)	RC0402FR-0747K	Yageo
L1-L4	4	1.8uH ±5%, .410A, Ferrite Chip Inductor (0805)	0805LS-182XJLB	Coil Craft
T1, T2	2	3-800Mhz 50Ω, RF Transformer (4:1)	TC4-1WG2+	Mini Circuits
JP1, JP2, JP3	3	CONN HEADER VERT SGL 2 X 1 POS GOLD	961102-6404-AR	3M
JP4, JP5, JP6, JP7	4	CONN HEADER VERT SGL 3 X 1 POS GOLD	961103-6404-AR	3M
J1, J2, J7	3	Edge Launch SMA (0.250 inch pitch ground round)	142-0711-821	Emerson Johnson
J3, J4, J5, J6	4	Edge Launch SMA (0.375 inch pitch ground tabs)	142-0701-851	Emerson Johnson
U1	1	RF to IF Dual Downconverting MIXER 6 X 6 QFN36	F1178NBGI	IDT
	1	Printed Circuit Board	F1178 REV (01)	IDT
C7		No Installed Ceramic Capacitor (0402)	N/A	N/A

TOP MARKINGS

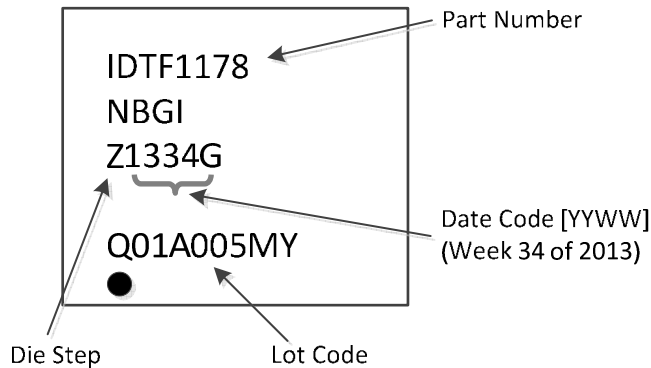

IMPORTANT NOTICE AND DISCLAIMER

RENESAS ELECTRONICS CORPORATION AND ITS SUBSIDIARIES (“RENESAS”) PROVIDES TECHNICAL SPECIFICATIONS AND RELIABILITY DATA (INCLUDING DATASHEETS), DESIGN RESOURCES (INCLUDING REFERENCE DESIGNS), APPLICATION OR OTHER DESIGN ADVICE, WEB TOOLS, SAFETY INFORMATION, AND OTHER RESOURCES “AS IS” AND WITH ALL FAULTS, AND DISCLAIMS ALL WARRANTIES, EXPRESS OR IMPLIED, INCLUDING, WITHOUT LIMITATION, ANY IMPLIED WARRANTIES OF MERCHANTABILITY, FITNESS FOR A PARTICULAR PURPOSE, OR NON-INFRINGEMENT OF THIRD PARTY INTELLECTUAL PROPERTY RIGHTS.

These resources are intended for developers skilled in the art designing with Renesas products. You are solely responsible for (1) selecting the appropriate products for your application, (2) designing, validating, and testing your application, and (3) ensuring your application meets applicable standards, and any other safety, security, or other requirements. These resources are subject to change without notice. Renesas grants you permission to use these resources only for development of an application that uses Renesas products. Other reproduction or use of these resources is strictly prohibited. No license is granted to any other Renesas intellectual property or to any third party intellectual property. Renesas disclaims responsibility for, and you will fully indemnify Renesas and its representatives against, any claims, damages, costs, losses, or liabilities arising out of your use of these resources. Renesas' products are provided only subject to Renesas' Terms and Conditions of Sale or other applicable terms agreed to in writing. No use of any Renesas resources expands or otherwise alters any applicable warranties or warranty disclaimers for these products.

(Disclaimer Rev.1.0 Mar 2020)

Corporate Headquarters

TOYOSU FORESIA, 3-2-24 Toyosu,
Koto-ku, Tokyo 135-0061, Japan
www.renesas.com

Contact Information

For further information on a product, technology, the most up-to-date version of a document, or your nearest sales office, please visit:
www.renesas.com/contact/

Trademarks

Renesas and the Renesas logo are trademarks of Renesas Electronics Corporation. All trademarks and registered trademarks are the property of their respective owners.