

Overview

The KEMET GTX metal case filters cover three-phase EMC requirements with a wide variety of characteristics. By using nanocrystalline core material, these filters achieve excellent attenuation characteristics in a compact size. In addition, 6 different combinations of Y capacitors can be selected to support various equipment topologies. These filters are compact and lightweight due to its high mechanical density.

Applications

- Industrial equipment
- General purpose inverter
- Process automation
- Machine tools

Benefits

- Three-phase 500 VAC
- Current range from 30 to 60 A
- Nanocrystalline core material
- Selection of Y capacitors combinations
- Compact and lightweight
- Operating temperature range from -25°C to +55°C
- UL, c-UL, and TÜV approved
- RoHS compliant



Part Number System

GTX-	3	300-	Y000
Series	Phase	Rated Current (A)	Class Y Capacitors
GTX	3 = Three-phase	xx0 = xx A	Y000 = None Y103 = 10,000 pF Y473 = 47,000 pF Y683 = 68,000 pF Y104 = 100,000 pF Y474 = 470,000 pF

Dimensions – Millimeters

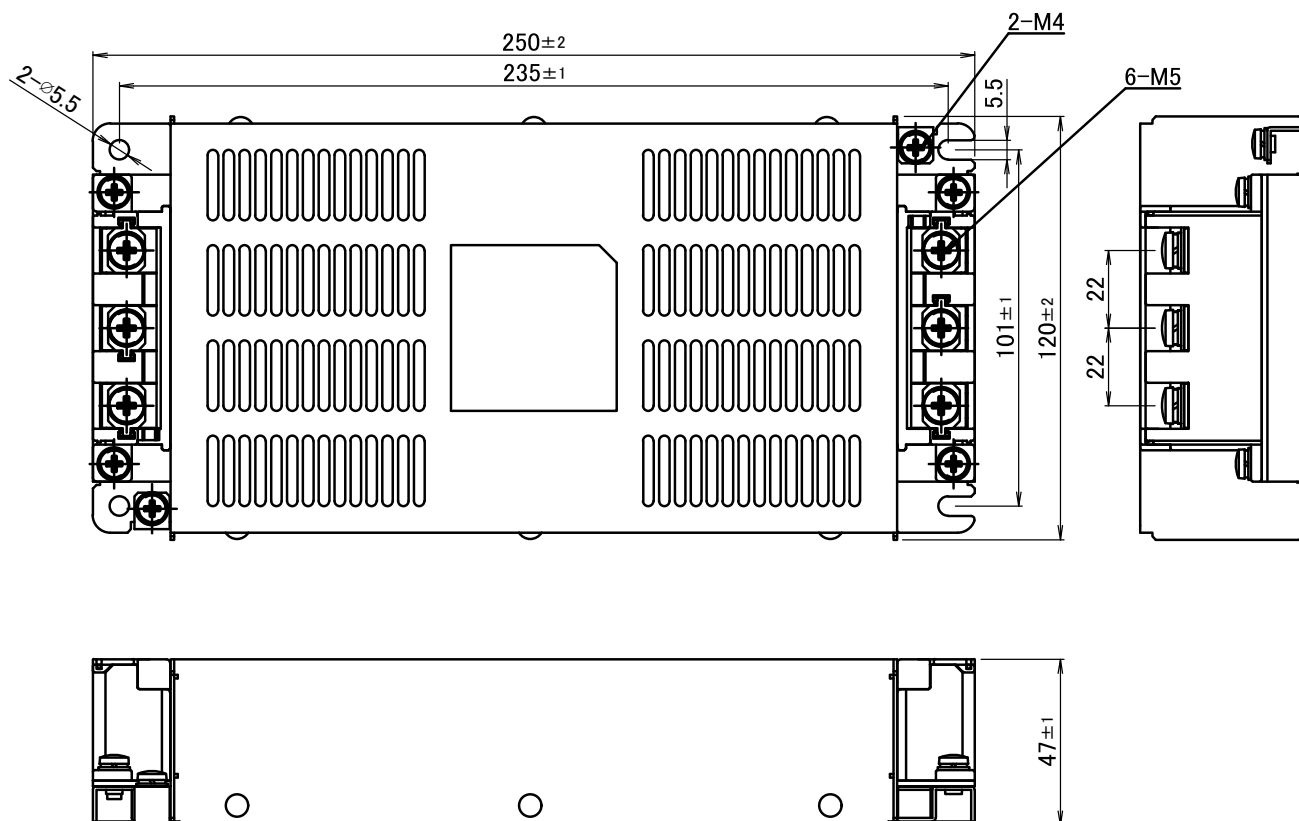

Environmental Compliance

KEMET GTX EMI-RFI Filters comply with EU RoHS Directive 2011/65/EU and (EU) 2015/863. Products that fall under the exemptions listed in below table are also included.



Series	RoHS Compliant	RoHS Exemption Code
GTX	Yes	7(c)-I

Code	Exemption
7(c)-I	Electrical and electronic components containing lead in a glass or ceramic other than dielectric ceramic in capacitors, e.g. piezoelectric devices, or in a glass or ceramic matrix compound

Approvals

Certification Body	File Number	Part Number
UL/cUL	E506378	All GTX Three Phase EMI-RFI Filters
TÜV Rheinland Japan Ltd.	R50533081	All GTX Three Phase EMI-RFI Filters

Derating Curve

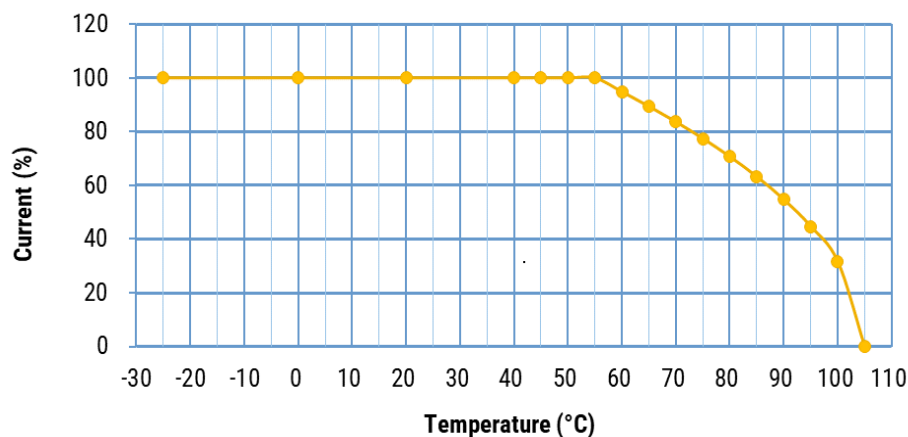

Performance Characteristics

Item	Performance Characteristics
Rated Voltage	500 VAC (50/60 Hz) and 500 VDC ¹
Rated Current Range	30 – 60 A
Withstanding Voltage	2,800 VDC (1 minute, line to ground)
Insulation Resistance	6,000 MΩ minimum at 500 VDC (1 minute, line to ground)
Leakage Current Range	0.03 – 92 mA maximum at 500 V/60 Hz
Input/Output Terminal Type	Screw
Operating Temperature Range	-25°C to +55°C (not including self temperature rise)

¹ Rated voltage AC250 / DC353.5 for c-UL approval standards.

Table 1 – Ratings & Part Number Reference

Part Number	Phase	Rated Voltage AC/DC ¹ (V)	Rated Current AC/DC (A)	Leakage Current at 500 V/ 60 Hz (mA) Maximum	Temperature Rise ² (K) Maximum	Operating Temperature Range	Terminal Type	Approval	Weight (Kg)
GTX-3300-Y000	Three-phase	AC500/DC500	30	0.03	60	-25°C to +55°C	Screw	UL, c-UL, and TÜV	1.73
GTX-3300-Y103	Three-phase	AC500/DC500	30	2.00	60	-25°C to +55°C	Screw	UL, c-UL, and TÜV	1.73
GTX-3300-Y473	Three-phase	AC500/DC500	30	9.00	60	-25°C to +55°C	Screw	UL, c-UL, and TÜV	1.73
GTX-3300-Y683	Three-phase	AC500/DC500	30	13.00	60	-25°C to +55°C	Screw	UL, c-UL, and TÜV	1.74
GTX-3300-Y104	Three-phase	AC500/DC500	30	20.00	60	-25°C to +55°C	Screw	UL, c-UL, and TÜV	1.74
GTX-3300-Y474	Three-phase	AC500/DC500	30	92.00	60	-25°C to +55°C	Screw	UL, c-UL, and TÜV	1.75
GTX-3400-Y000	Three-phase	AC500/DC500	40	0.03	60	-25°C to +55°C	Screw	UL, c-UL, and TÜV	1.74
GTX-3400-Y103	Three-phase	AC500/DC500	40	2.00	60	-25°C to +55°C	Screw	UL, c-UL, and TÜV	1.74
GTX-3400-Y473	Three-phase	AC500/DC500	40	9.00	60	-25°C to +55°C	Screw	UL, c-UL, and TÜV	1.74
GTX-3400-Y683	Three-phase	AC500/DC500	40	13.00	60	-25°C to +55°C	Screw	UL, c-UL, and TÜV	1.74
GTX-3400-Y104	Three-phase	AC500/DC500	40	20.00	60	-25°C to +55°C	Screw	UL, c-UL, and TÜV	1.74
GTX-3400-Y474	Three-phase	AC500/DC500	40	92.00	60	-25°C to +55°C	Screw	UL, c-UL, and TÜV	1.76
GTX-3500-Y000	Three-phase	AC500/DC500	50	0.03	60	-25°C to +55°C	Screw	UL, c-UL, and TÜV	1.71
GTX-3500-Y103	Three-phase	AC500/DC500	50	2.00	60	-25°C to +55°C	Screw	UL, c-UL, and TÜV	1.71
GTX-3500-Y473	Three-phase	AC500/DC500	50	9.00	60	-25°C to +55°C	Screw	UL, c-UL, and TÜV	1.71
GTX-3500-Y683	Three-phase	AC500/DC500	50	13.00	60	-25°C to +55°C	Screw	UL, c-UL, and TÜV	1.71
GTX-3500-Y104	Three-phase	AC500/DC500	50	20.00	60	-25°C to +55°C	Screw	UL, c-UL, and TÜV	1.71
GTX-3500-Y474	Three-phase	AC500/DC500	50	92.00	60	-25°C to +55°C	Screw	UL, c-UL, and TÜV	1.73
GTX-3600-Y000	Three-phase	AC500/DC500	60	0.03	60	-25°C to +55°C	Screw	UL, c-UL, and TÜV	1.68
GTX-3600-Y103	Three-phase	AC500/DC500	60	2.00	60	-25°C to +55°C	Screw	UL, c-UL, and TÜV	1.68
GTX-3600-Y473	Three-phase	AC500/DC500	60	9.00	60	-25°C to +55°C	Screw	UL, c-UL, and TÜV	1.69
GTX-3600-Y683	Three-phase	AC500/DC500	60	13.00	60	-25°C to +55°C	Screw	UL, c-UL, and TÜV	1.69
GTX-3600-Y104	Three-phase	AC500/DC500	60	20.00	60	-25°C to +55°C	Screw	UL, c-UL, and TÜV	1.69
GTX-3600-Y474	Three-phase	AC500/DC500	60	92.00	60	-25°C to +55°C	Screw	UL, c-UL, and TÜV	1.71
Part Number	Phase	Rated Voltage	Rated Current	Leakage Current	Temperature Rise	Operating Temperature Range	Terminal Type	Approval	Weight

¹ Rated voltage AC250 / DC353.5 for c-UL approval standards.

² Coil surface temperature.

Circuit Diagram

Circuit Diagram

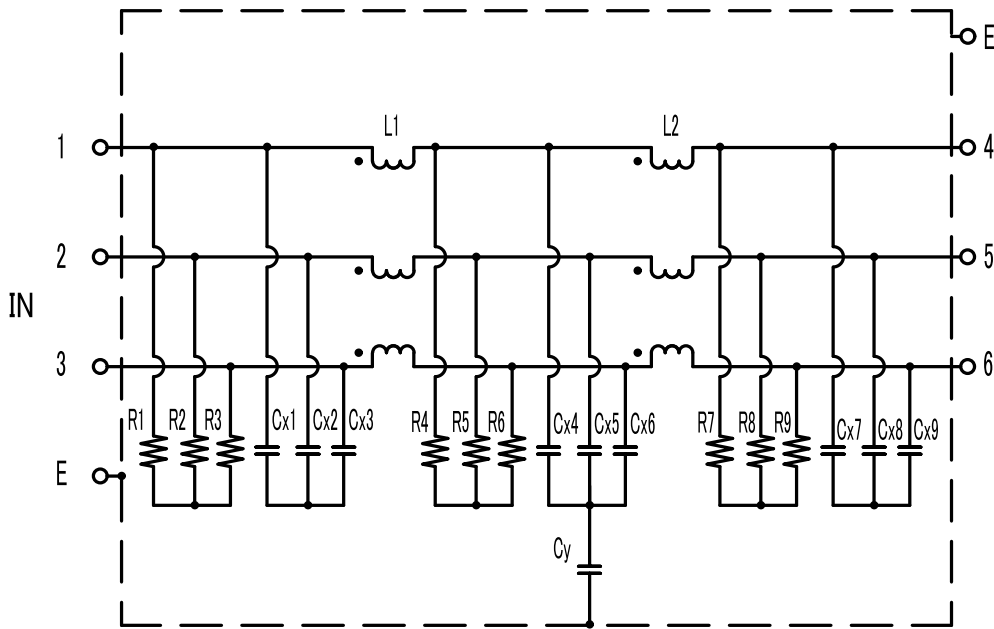

Measuring Circuit - Common Mode

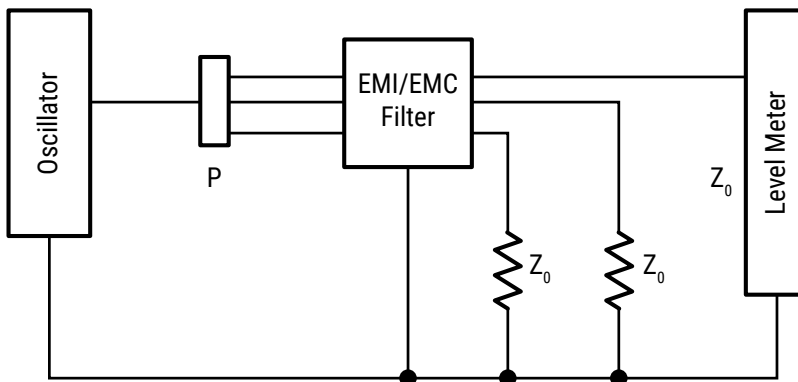

P: Power Divider Z₀: 50 Ω

Attenuation (Static Characteristics)

GTX-3300-Y*** Common Mode

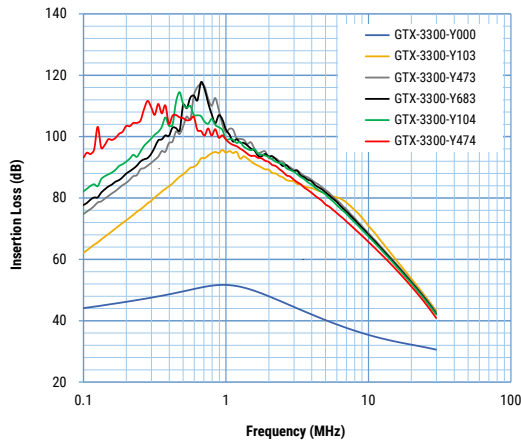

GTX-3400-Y*** Common Mode

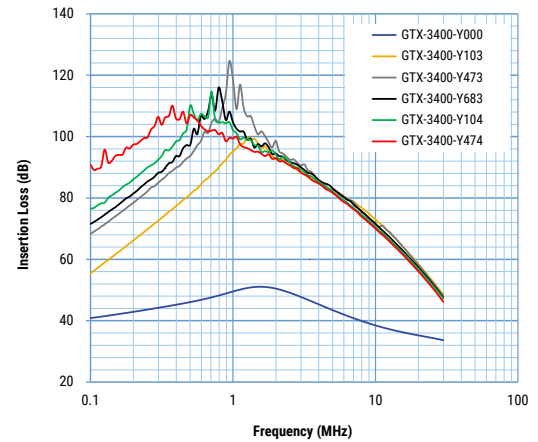

GTX-3500-Y*** Common Mode

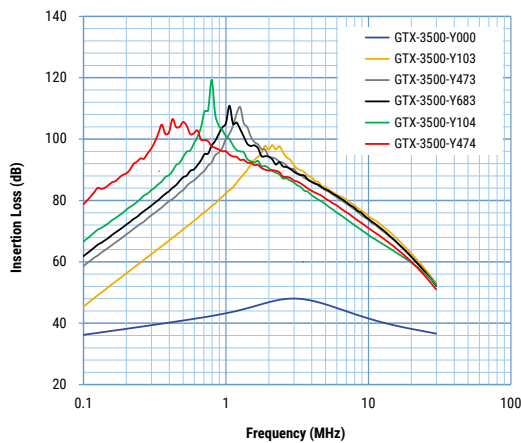

GTX-3600-Y*** Common Mode

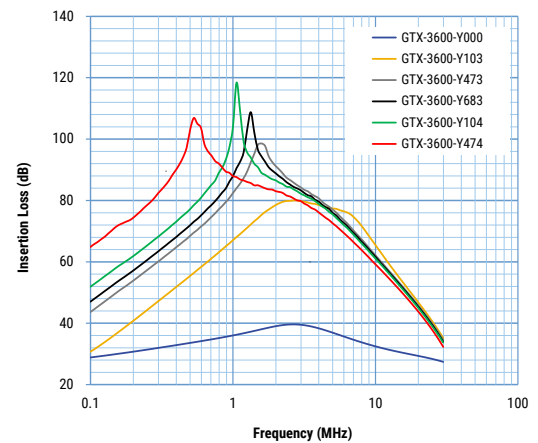

GTX-3300-Y000

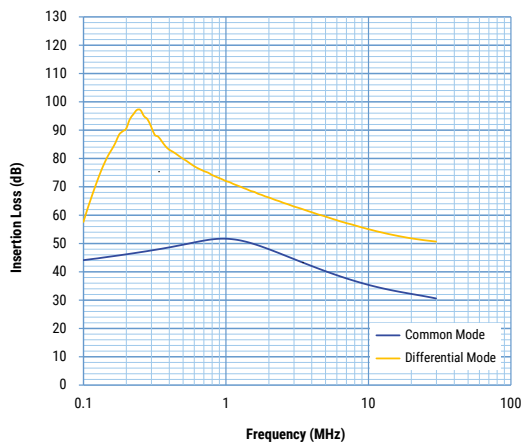

GTX-3300-Y103

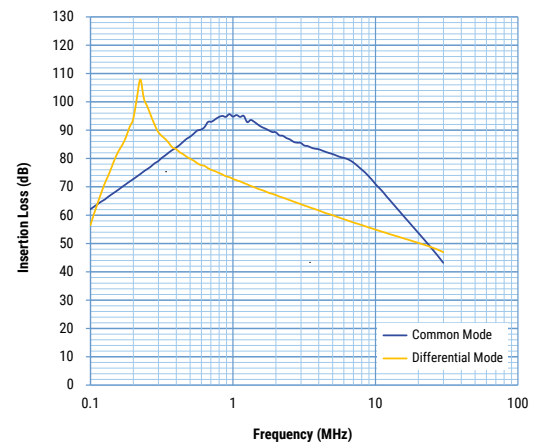

Attenuation (Static Characteristics) cont.

GTX-3300-Y473

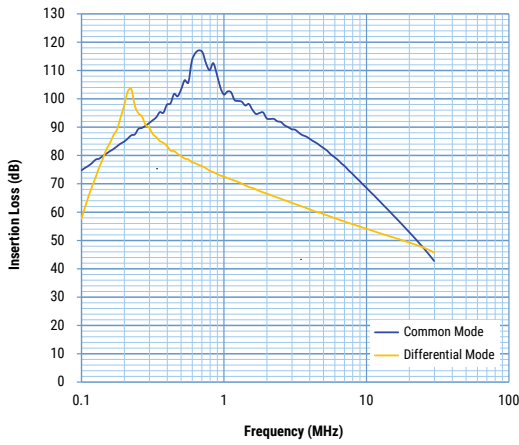

GTX-3300-Y683

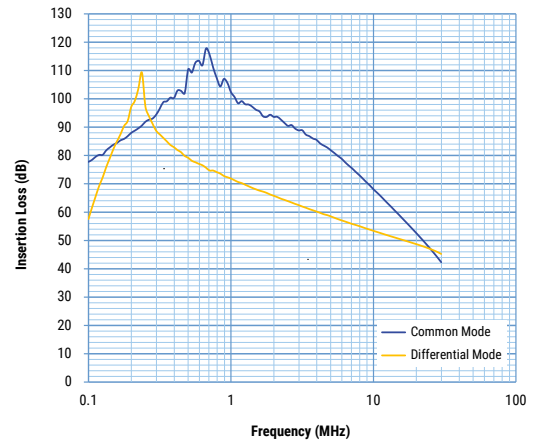

GTX-3300-Y104

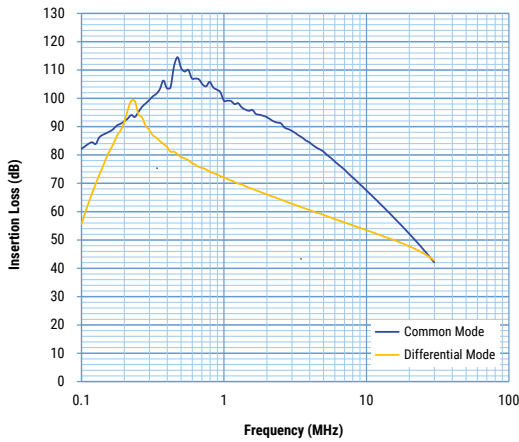

GTX-3300-Y474

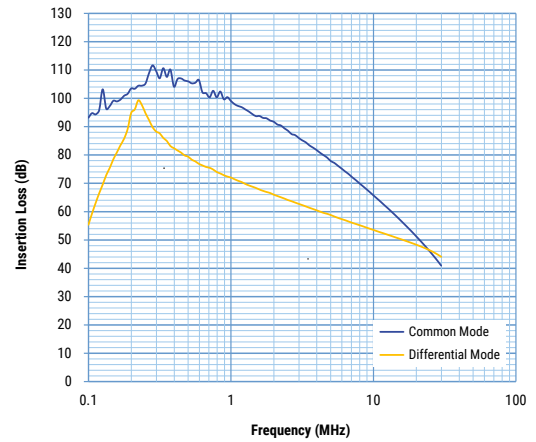

GTX-3400-Y000

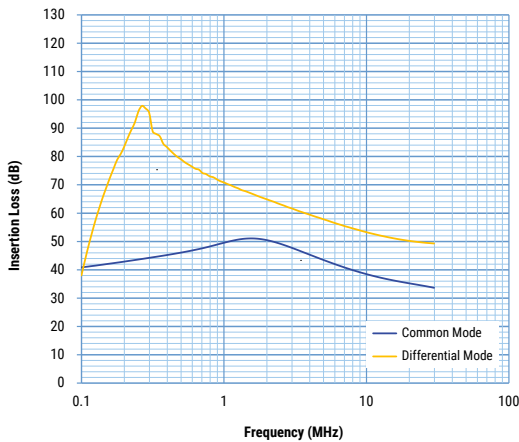

GTX-3400-Y103

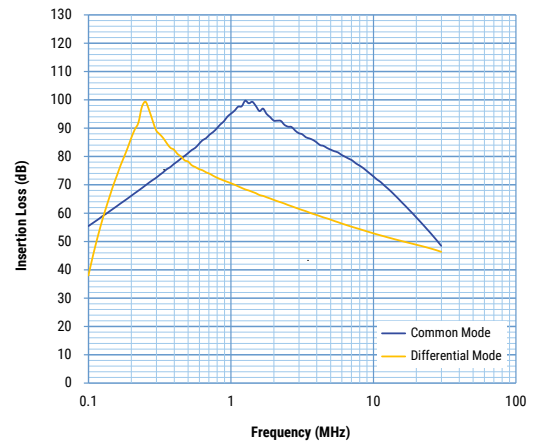

Attenuation (Static Characteristics) cont.

GTX-3400-Y473

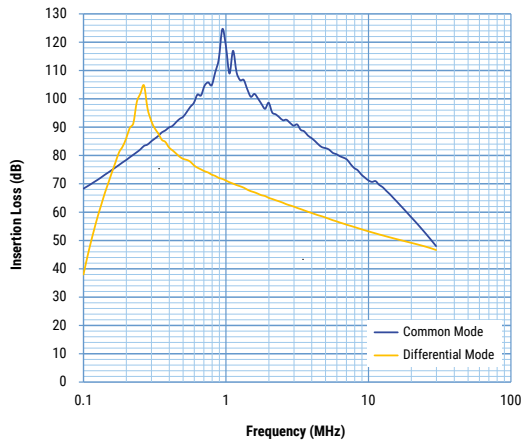

GTX-3400-Y683

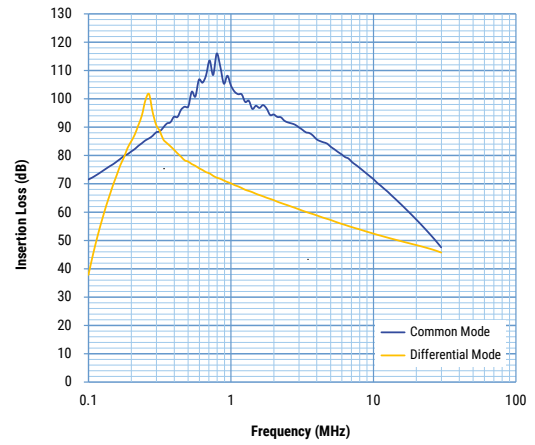

GTX-3400-Y104

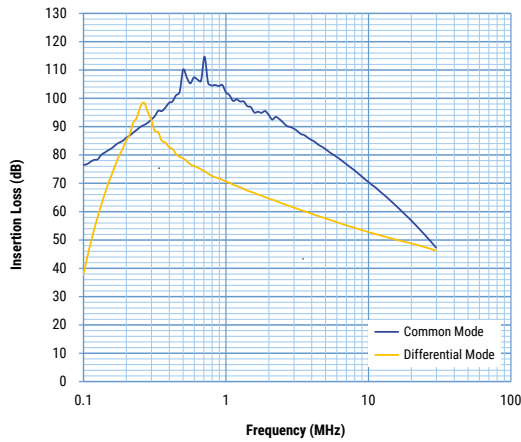

GTX-3400-Y474

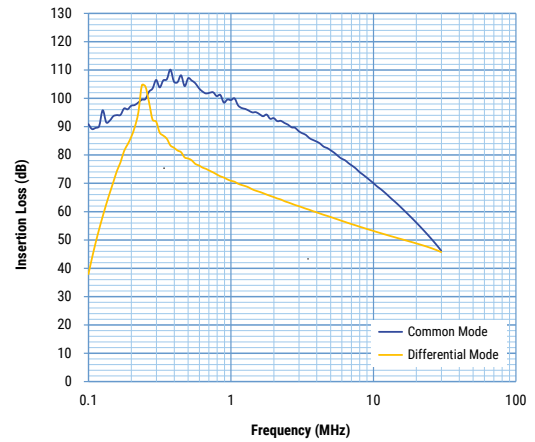

GTX-3500-Y000

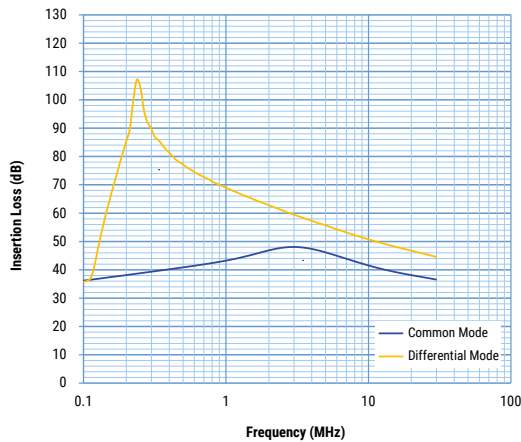

GTX-3500-Y103

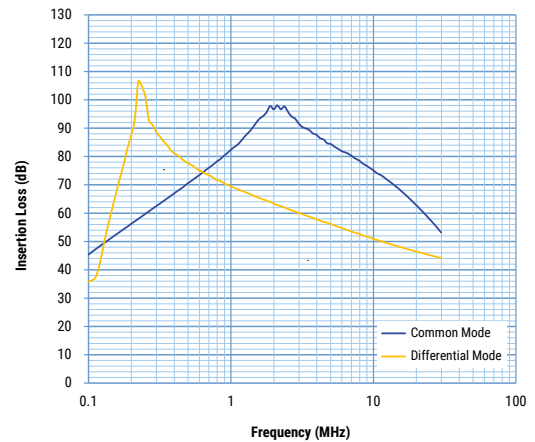

Attenuation (Static Characteristics) cont.

GTX-3500-Y473

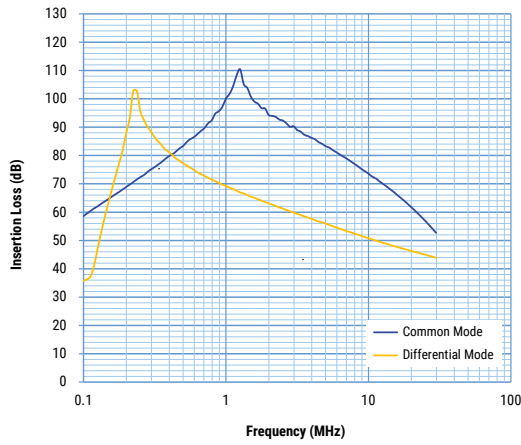

GTX-3500-Y683

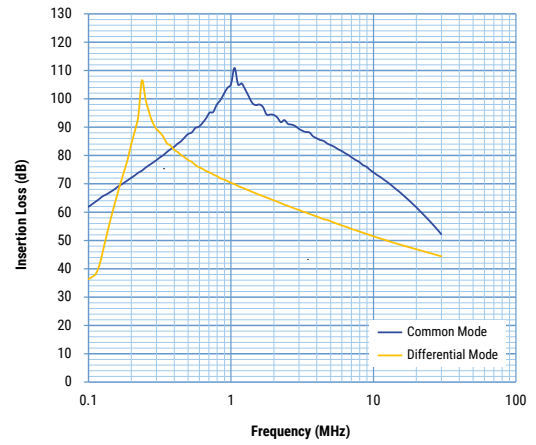

GTX-3500-Y104

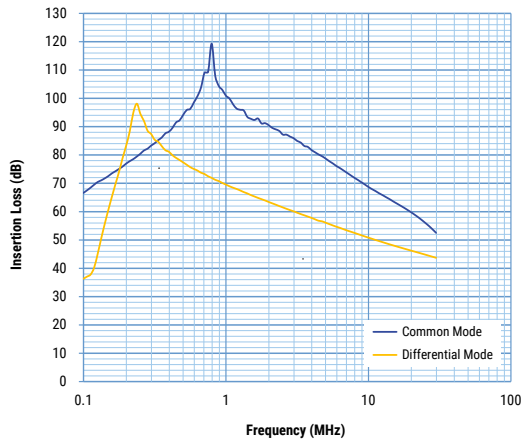

GTX-3500-Y474

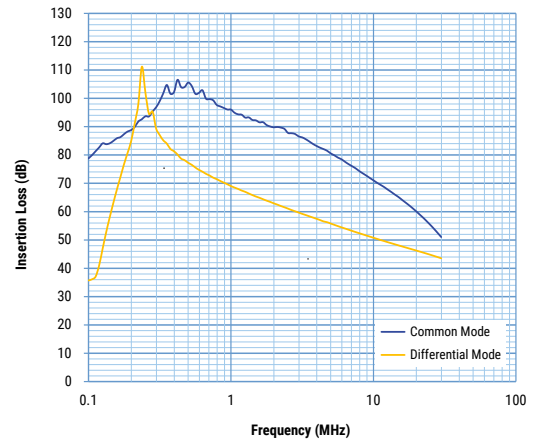

GTX-3600-Y000

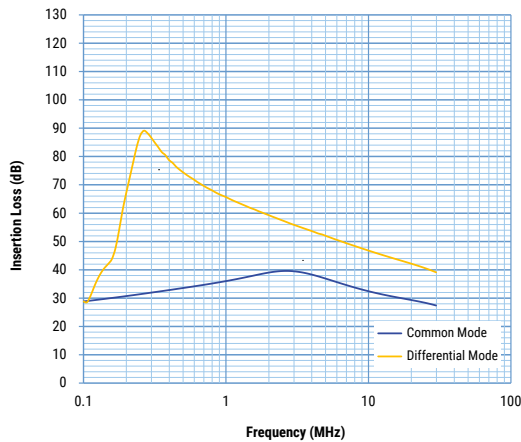

GTX-3600-Y103

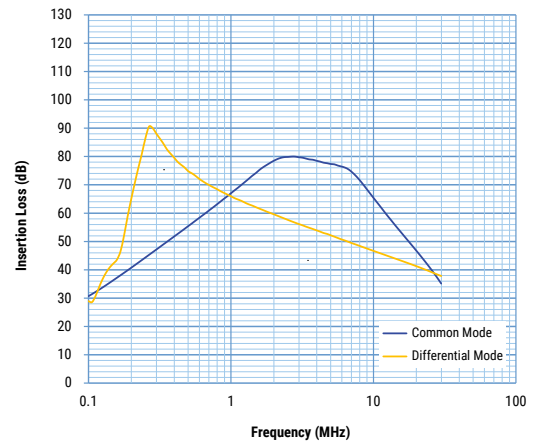

Attenuation (Static Characteristics) cont.

GTX-3600-Y473

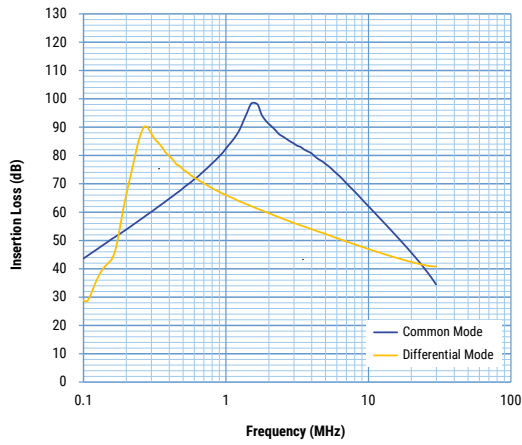

GTX-3600-Y683

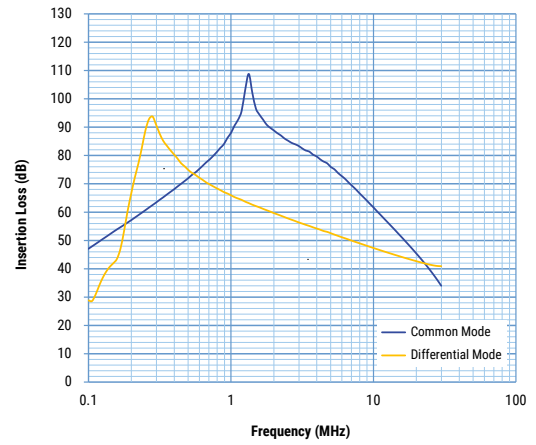

GTX-3600-Y104

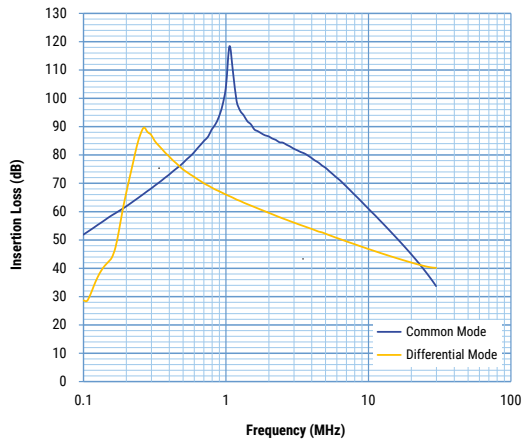

GTX-3600-Y474

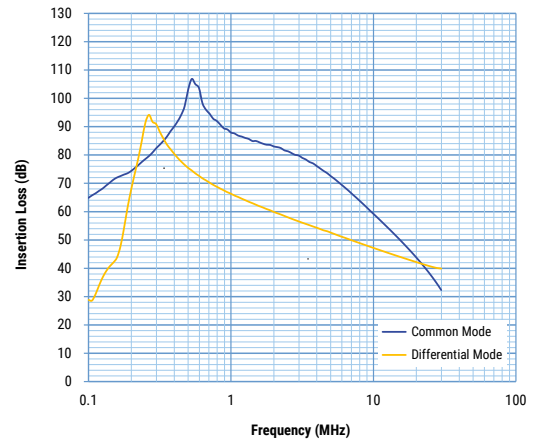

Packaging

Part Type	Packaging Type	Pieces per Box
GTX-3**0-Y***	Box	4

Handling Precautions

Precautions for product storage

EMI-RFI Filters should be stored in normal working environments. While the filters themselves are quite robust in other environments, solderability will be degraded by exposure to high temperatures, high humidity, corrosive atmospheres, and long term storage.

KEMET recommends that maximum storage temperature not exceed 40°C and maximum storage humidity not exceed 70% relative humidity and atmospheres should be free of chlorine and sulfur bearing compounds. Temperature fluctuations should be minimized to avoid condensation on the parts. Also, avoid storage near strong magnetic fields as this might magnetize the product.

EMI-RFI Filters' stock should be used promptly, preferably within 12 months of receipt.

KEMET Electronics Corporation Sales Offices

For a complete list of our global sales offices, please visit www.kemet.com/sales.

Disclaimer

All product specifications, statements, information and data (collectively, the "Information") in this datasheet are subject to change. The customer is responsible for checking and verifying the extent to which the Information contained in this publication is applicable to an order at the time the order is placed. All Information given herein is believed to be accurate and reliable, but it is presented without guarantee, warranty, or responsibility of any kind, expressed or implied.

Statements of suitability for certain applications are based on KEMET Electronics Corporation's ("KEMET") knowledge of typical operating conditions for such applications, but are not intended to constitute – and KEMET specifically disclaims – any warranty concerning suitability for a specific customer application or use. The Information is intended for use only by customers who have the requisite experience and capability to determine the correct products for their application. Any technical advice inferred from this Information or otherwise provided by KEMET with reference to the use of KEMET's products is given gratis, and KEMET assumes no obligation or liability for the advice given or results obtained.

Although KEMET designs and manufactures its products to the most stringent quality and safety standards, given the current state of the art, isolated component failures may still occur. Accordingly, customer applications which require a high degree of reliability or safety should employ suitable designs or other safeguards (such as installation of protective circuitry or redundancies) in order to ensure that the failure of an electrical component does not result in a risk of personal injury or property damage.

Although all product-related warnings, cautions and notes must be observed, the customer should not assume that all safety measures are indicated or that other measures may not be required.

When providing KEMET products and technologies contained herein to other countries, the customer must abide by the procedures and provisions stipulated in all applicable export laws and regulations, including without limitation the International Traffic in Arms Regulations (ITAR), the US Export Administration Regulations (EAR) and the Japan Foreign Exchange and Foreign Trade Act.

KEMET is a registered trademark of KEMET Electronics Corporation.