

DIN Rail Mount 45 mm FN Part number 84870501



- Automatic control and regulation of liquid levels.
- 2 sensitivity ranges.
- Filling or emptying function selected via dip switch.
- High or low alarm selected via dip switch.
- Memory can be selected.
- LEDs indicate state of power supply, output relay and alarm relay.

Part numbers

	Type	Voltages
84870501	FN	24 VAC

Specifications

Supply voltage Un	230, 120, 48 and 24 V AC 50/60 Hz galvanic isolation via transformer
Operating range	0.85 to 1.15 Un except 120 V AC : 0.85 to 1.1 Un
Nominal power	3 VA at Un
Maximal power	4 VA at Un + 15 %
Immunity from micro power cuts	10 ms
Delay on pick-up	T1 = approx. 2 s
Response time on power up	T4 = 500 ms
Insulation coordination	Category III, degree of pollution 2 conforming to IEC/EN 60664-1 : 4 kV/2
Sensitivity range FN	5 kΩ→100 kΩ
Sensitivity range FHLS	250 Ω→5 kΩ
Display precision	± 30 % with maximum sensitivity
Electrode voltage	15 V AC (50/60 Hz)
Electrode current	1 mA
Response time on immersion	T2 = 400 ms
Response time on emersion	T3 = 700 ms
Output	2 AgCdO changeover
Breaking capacity	FN LS : 2000 VA FN : 80 W
Maximum breaking current	FN LS : 8 A AC FN : 8 A DC
Minimum breaking current	FN LS : 100 mA AC FN : 100 mA DC
Max. breaking voltage	FN LS : 250 V AC FN : 250 V DC
Mechanical life (operations)	2 x 10 ⁶
Electrical life AC 12	2000 VA - 10 ⁵ operations
Electrical life AC 15	Cos φ = 0,3 - 6000 operations
Electrical life AC 13	L/R = 300 ms - 6000 operations
Housing material	Self-extinguishing
Terminal capacity	2 x 1,5 mm ² with ferrule 2 x 2,5 mm ² without ferrule
Temperature limit operation (IEC 68.1.14) (°C)	-20 →+60
Temperature limits stored (IEC 68.1.1/2) (°C)	-30 →+70
Relative humidity (no condensation)	93 % (+2 % ; -3 %)
Weight (g)	280

Principles

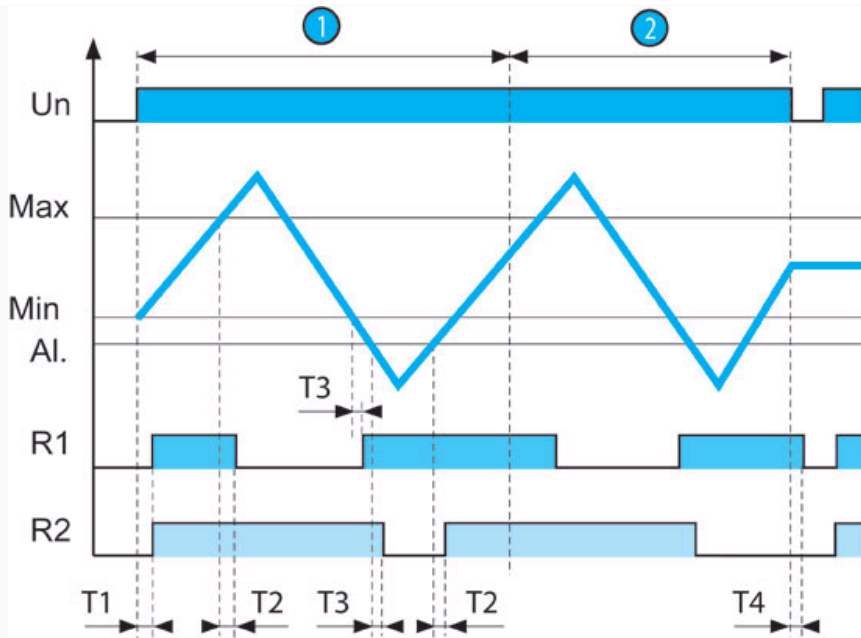

On power-up, probe Al. is submerged, relays R1 and R2 are energised and the pump is ON : filling starts, the LED for relay R1 is lit. When the level reaches the Max probe, relay R1 de-energises and the pump is OFF : filling stops, the LED for relay R1 goes off. Relay R1 re-energises when the Min probe emerges. In the event of a fault (level continues to fall) probe Al. emerges, relay R2 de-energises and the alarm is triggered : the LED for relay R2 is lit. This fault can be stored

N°	Legend
①	Memory OFF
②	Memory ON
	T1 : Delay on pick-up
	T2 : Response time on immersion
	T3 : Response time on emersion
	T4 : Response time on power-down

Principles

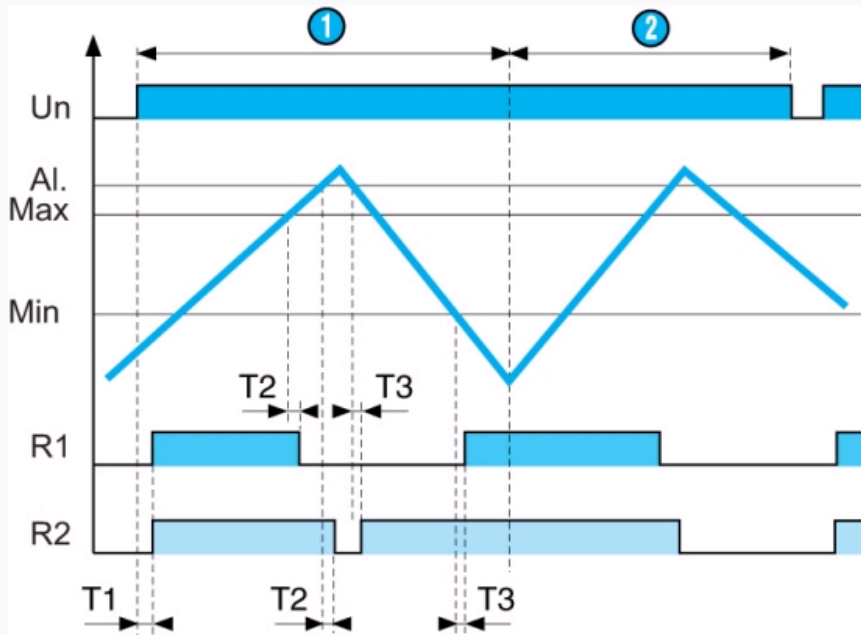

On power-up, the level in the tank is low, relays R1 and R2 are energised and the pump is ON : filling starts, the LED for relay R1 is lit. When the level reaches the Max probe, relay R1 de-energises and the pump is OFF : filling stops, the relay LED goes off. If, in the event of a fault, the level continues to rise and reaches probe Al., relay R2 de-energises and the alarm is triggered : the LED for relay R2 is lit. This fault can be stored.

N°	Legend
①	Memory OFF
②	Memory ON
	T1 : Delay on pick-up
	T2 : Response time on immersion
	T3 : Response time on emersion

Principles

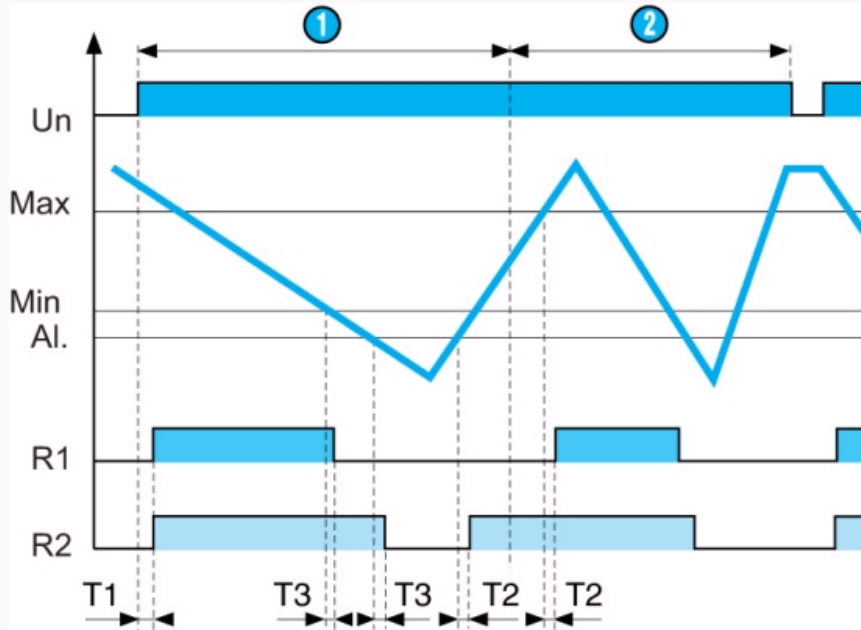

On power-up, probes Min, Max and Al. are submerged, relays R1 and R2 are energised and the pump is ON : emptying starts, the LED for relay R1 is lit. When the Min probe emerges, relay R1 goes off. If, in the event of a fault, the level continues to fall and probe Al. emerges, relay R2 de-energises and the alarm is triggered : the LED relay R2 is lit. This fault can be stored.

N°	Legend
①	Memory OFF
②	Memory ON
	T1 : Delay on pick-up
	T2 : Response time on immersion
	T3 : Response time on emersion

Principles

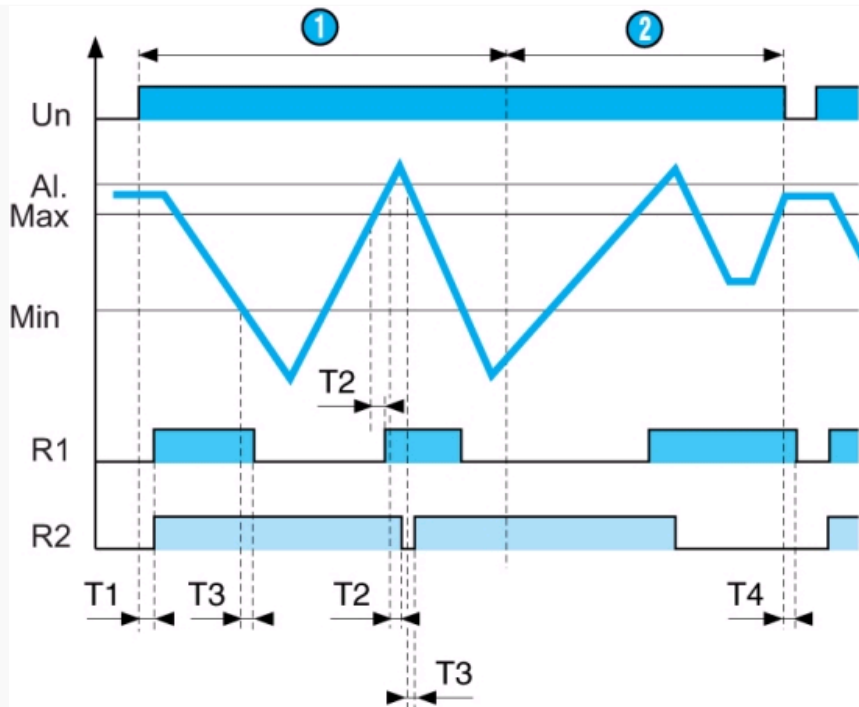

On power-up, probes Min, Max are submerged and probe Al. is above the level of the liquid. Relays R1 and R2 are energised and the pump is ON : emptying starts, the LED for relay R1 is lit. When the Min probe emerges, relay R1 de-energises and the pump is OFF : emptying stops, the LED for relay R1 goes off. If, in the event of a fault, the level continues to rise and reaches probe Al., relay R2 de-energises and the alarm is triggered : the LED for relay R2 is lit. This fault can be stored.

N°	Legend
1	Memory OFF
2	Memory ON
	T1 : Delay on pick-up
	T2 : Response time on immersion
	T3 : Response time on emersion
	T4 : Response time on power-down

Principles

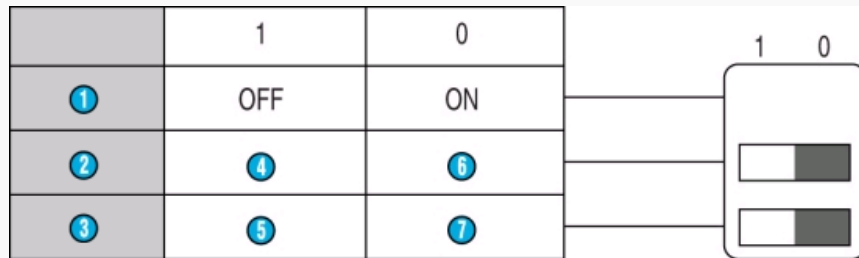

Operating principle

Control of the level of a conductive liquid at specific points (high and low levels) with an alarm for a level which is abnormally high or low. The principle is based on measurement of the apparent resistance of the liquid between submerged probes. When this value is lower than the present threshold on the unit front face, the output relay R1 and/or the alarm relay R2 change state. To avoid electrolytic phenomena, an AC current runs across the probes.

Adjusting sensitivity

Set the sensitivity so that the relay will change state when the probes are in contact with the liquid. Then check that the relay returns to its initial position as soon as the probes emerge. In certain applications, fine-tuning the sensitivity prevents inappropriate detection, such as the presence of foam or bubbles on the surface or the occurrence of leakage impedance between probes (extended line capacity, humidity, etc).

Note :

Latching of the alarm relay R2 in de-energised state if a fault occurs can be programmed via a switch on the underside of the underside of the unit (only when the unit is switched off). To reset alarm relay R2, cut the power, as long as the levels are reset.

Programming

The FN level controller can be programmed using 3 switches on the lower panel :

Note :

Memory, Alarm and Function must only be selected when the unit is switched off.

N°	Legend
----	--------

1	Memory
2	Alarm
3	Function
4	Low
5	Emptying
6	High
7	Filling

Dimensions (mm)

FN / FN LS

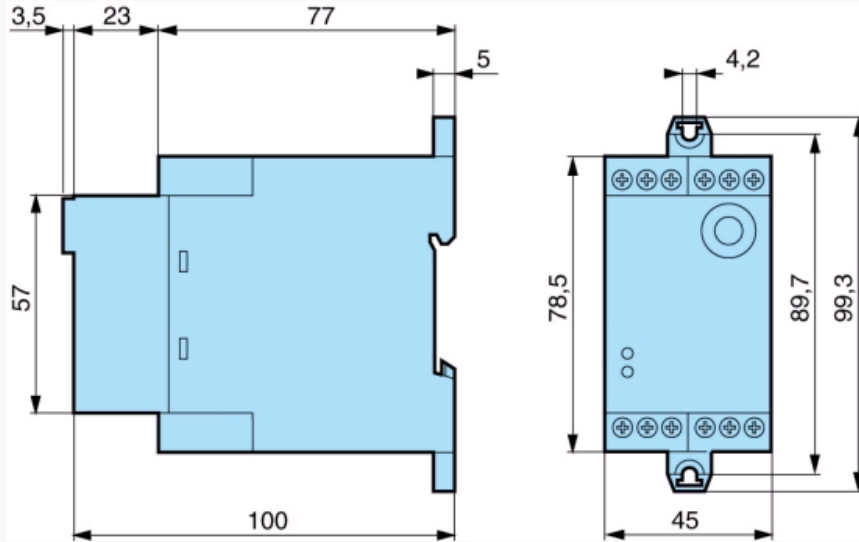

Connections

Regulating with "up" filling control

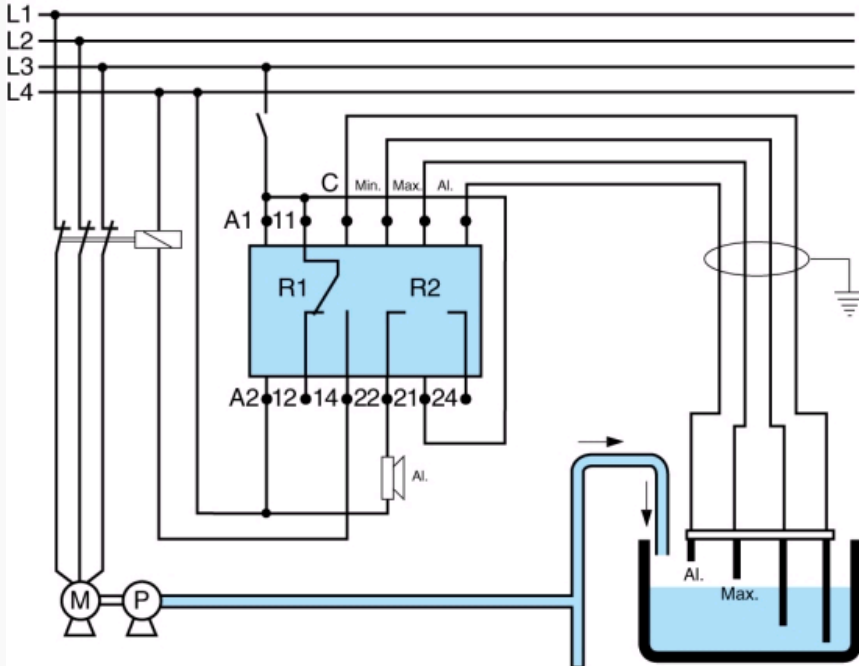

Note : In case of metallic tank, it could be used as probe (C). A green LED indicates the presence of the supply voltage A yellow LED indicates the status of the output relay A red LED indicates the status of the alarm

Legend

A1 - A2 : Supply voltage

11 - 12 - 14 : Output relay (R1)
21 - 22 - 24 : Alarm output relay (R2)
C - Min - Max - Al. : Probe inputs