

UNCONTROLLED DOCUMENT

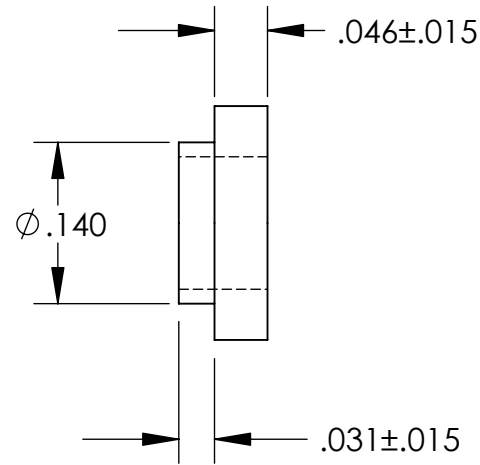
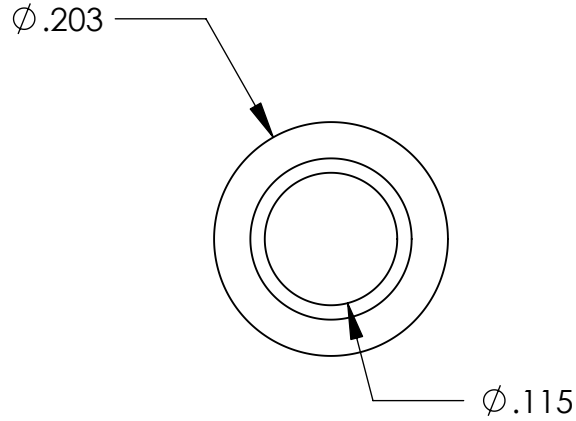

TOLERANCES UNLESS NOTED

- $\pm .005$ ON DIMENSIONS THRU $.625$
- $\pm .008$ ON DIMENSIONS $.626$ THRU 1.000
- $\pm .010$ ON DIMENSIONS 1.001 THRU 1.500
- $\pm .015$ ON DIMENSIONS LARGER THAN 1.500
- $\pm .015$ ON FRACTIONAL DIMENSIONS

WE RESERVE THE RIGHT
TO DISCONTINUE ITEMS,
CHANGE SPECIFICATIONS
OR DESIGN AT ANY TIME
WITHOUT NOTICE AND
WITHOUT INCURRING
ANY OBLIGATIONS

PROPERTY OF
MICRO PLASTICS INC.

CATALOG DRAWING
SHOULDER WASHER
MICRO P/N 12SWS0233
DWG. # 12SWS0233
FILE SERVER\ENG\WEB

MATERIAL: 6/6 NYLON

DATE

SCALE
6:1

TA