

# NCV8405A, NCV8405B

## Self-Protected Low Side Driver with Temperature and Current Limit

NCV8405A/B is a three terminal protected Low-Side Smart Discrete device. The protection features include overcurrent, overtemperature, ESD and integrated Drain-to-Gate clamping for overvoltage protection. This device is suitable for harsh automotive environments.

### Features

- Short-Circuit Protection
- Thermal Shutdown with Automatic Restart
- Overvoltage Protection
- Integrated Clamp for Inductive Switching
- ESD Protection
- dV/dt Robustness
- Analog Drive Capability (Logic Level Input)
- NCV Prefix for Automotive and Other Applications Requiring Unique Site and Control Change Requirements; AEC-Q101 Qualified and PPAP Capable
- These Devices are Pb-Free, Halogen Free/BFR Free and are RoHS Compliant

### Typical Applications

- Switch a Variety of Resistive, Inductive and Capacitive Loads
- Can Replace Electromechanical Relays and Discrete Circuits
- Automotive / Industrial



ON Semiconductor®

[www.onsemi.com](http://www.onsemi.com)

| $V_{(BR)DSS}$<br>(Clamped) | $R_{DS(ON)}$ TYP | $I_D$ MAX |
|----------------------------|------------------|-----------|
| 42 V                       | 90 mΩ @ 10 V     | 6.0 A*    |

\*Max current limit value is dependent on input condition.

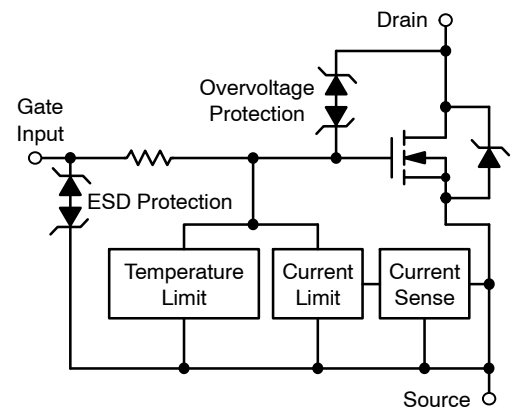

### MARKING DIAGRAM

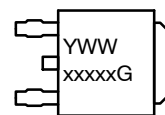
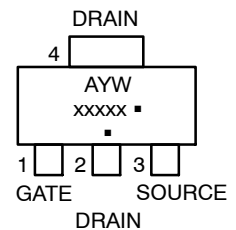

A = Assembly Location

Y = Year

W, WW = Work Week

xxxxx = 8405A or 8405B

G or ■ = Pb-Free Package

(Note: Microdot may be in either location)

### ORDERING INFORMATION

See detailed ordering and shipping information in the package dimensions section on page 10 of this data sheet.

# NCV8405A, NCV8405B

## MAXIMUM RATINGS (T<sub>J</sub> = 25°C unless otherwise noted)

| Rating   | Symbol   | Value              | Unit |
|--|--|--------------------|------|
| Drain-to-Source Voltage Internally Clamped   | V <sub>DSS</sub>   | 42                 | V    |
| Drain-to-Gate Voltage Internally Clamped (R <sub>G</sub> = 1.0 MΩ)   | V <sub>DGR</sub>   | 42                 | V    |
| Gate-to-Source Voltage   | V <sub>GS</sub>  | ± 14               | V    |
| Continuous Drain Current   | I <sub>D</sub>   | Internally Limited |      |
| Power Dissipation – SOT-223 Version<br>@ T <sub>A</sub> = 25°C (Note 1)<br>@ T <sub>A</sub> = 25°C (Note 2)<br>@ T <sub>S</sub> = 25°C   | P <sub>D</sub>   | 1.0                | W    |
| Power Dissipation – DPAK Version<br>@ T <sub>A</sub> = 25°C (Note 1)<br>@ T <sub>A</sub> = 25°C (Note 2)<br>@ T <sub>S</sub> = 25°C  |  | 2.0<br>2.5<br>40   |      |
| Thermal Resistance – SOT-223 Version<br>Junction-to-Ambient Steady State (Note 1)<br>Junction-to-Ambient Steady State (Note 2)<br>Junction-to-Soldering Point Steady State               | R <sub>θJA</sub><br>R <sub>θJA</sub><br>R <sub>θJS</sub> | 130<br>72<br>11    | °C/W |
| Thermal Resistance – DPAK Version<br>Junction-to-Ambient Steady State (Note 1)<br>Junction-to-Ambient Steady State (Note 2)<br>Junction-to-Soldering Point Steady State                  | R <sub>θJA</sub><br>R <sub>θJA</sub><br>R <sub>θJS</sub> | 60<br>50<br>3.0    |      |
| Single Pulse Drain-to-Source Avalanche Energy<br>(V <sub>DD</sub> = 40 V, V <sub>G</sub> = 5.0 V, I <sub>PK</sub> = 2.8 A, L = 80 mH, R <sub>G(ext)</sub> = 25 Ω, T <sub>J</sub> = 25°C) | E <sub>AS</sub>  | 275                | mJ   |
| Load Dump Voltage V <sub>LD</sub> = V <sub>A</sub> + V <sub>S</sub> (V <sub>GS</sub> = 0 and 10 V, R <sub>I</sub> = 2.0 Ω, R <sub>L</sub> = 6.0 Ω, t <sub>d</sub> = 400 ms)              | V <sub>LD</sub>  | 53                 | V    |
| Operating Junction Temperature   | T <sub>J</sub>   | -40 to 150         | °C   |
| Storage Temperature  | T <sub>stg</sub>   | -55 to 150         | °C   |

Stresses exceeding those listed in the Maximum Ratings table may damage the device. If any of these limits are exceeded, device functionality should not be assumed, damage may occur and reliability may be affected.

- Surface-mounted onto min pad FR4 PCB, (2 oz. Cu, 0.06" thick).
- Surface-mounted onto 2" sq. FR4 board (1" sq., 1 oz. Cu, 0.06" thick).

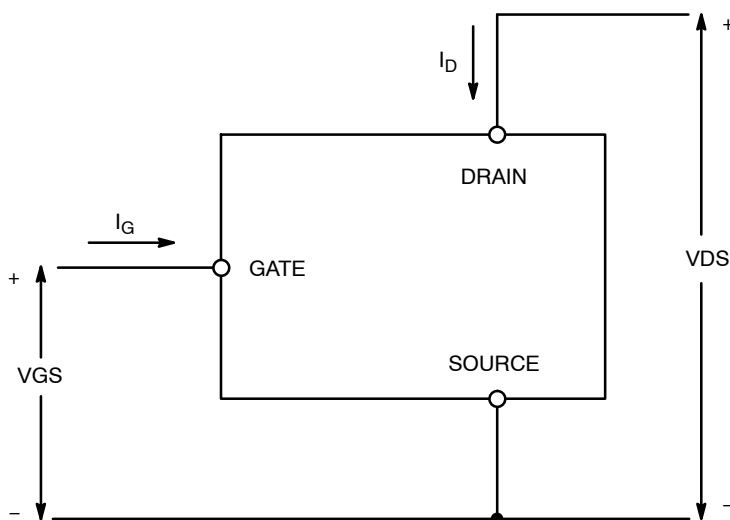

**Figure 1. Voltage and Current Convention**

# NCV8405A, NCV8405B

## ELECTRICAL CHARACTERISTICS (T<sub>J</sub> = 25°C unless otherwise noted)

| Parameter                                  | Test Condition   | Symbol               | Min | Typ | Max | Unit |
|--|--|----------------------|-----|-----|-----|------|
| <b>OFF CHARACTERISTICS</b>                 |  |                      |     |     |     |      |
| Drain-to-Source Breakdown Voltage (Note 3) | V <sub>GS</sub> = 0 V, I <sub>D</sub> = 10 mA, T <sub>J</sub> = 25°C           | V <sub>(BR)DSS</sub> | 42  | 46  | 51  | V    |
|  | V <sub>GS</sub> = 0 V, I <sub>D</sub> = 10 mA, T <sub>J</sub> = 150°C (Note 5) |                      | 42  | 45  | 51  |      |
| Zero Gate Voltage Drain Current            | V <sub>GS</sub> = 0 V, V <sub>DS</sub> = 32 V, T <sub>J</sub> = 25°C           | I <sub>DSS</sub>     |     | 0.5 | 2.0 | μA   |
|  | V <sub>GS</sub> = 0 V, V <sub>DS</sub> = 32 V, T <sub>J</sub> = 150°C (Note 5) |                      |     | 2.0 | 10  |      |
| Gate Input Current                         | V <sub>DS</sub> = 0 V, V <sub>GS</sub> = 5.0 V                                 | I <sub>GSSF</sub>    |     | 50  | 100 | μA   |

## ON CHARACTERISTICS (Note 3)

|  |  |                                     |     |      |     |        |
|--|--|-------------------------------------|-----|------|-----|--------|
| Gate Threshold Voltage                 | V <sub>GS</sub> = V <sub>DS</sub> , I <sub>D</sub> = 150 μA                      | V <sub>GS(th)</sub>                 | 1.0 | 1.6  | 2.0 | V      |
| Gate Threshold Temperature Coefficient |  | V <sub>GS(th)</sub> /T <sub>J</sub> |     | 4.0  |     | -mV/°C |
| Static Drain-to-Source On-Resistance   | V <sub>GS</sub> = 10 V, I <sub>D</sub> = 1.4 A, T <sub>J</sub> = 25°C            | R <sub>DS(on)</sub>                 |     | 90   | 100 | mΩ     |
|  | V <sub>GS</sub> = 10 V, I <sub>D</sub> = 1.4 A, T <sub>J</sub> = 150°C (Note 5)  |                                     |     | 165  | 190 |        |
|  | V <sub>GS</sub> = 5.0 V, I <sub>D</sub> = 1.4 A, T <sub>J</sub> = 25°C           |                                     |     | 105  | 120 |        |
|  | V <sub>GS</sub> = 5.0 V, I <sub>D</sub> = 1.4 A, T <sub>J</sub> = 150°C (Note 5) |                                     |     | 185  | 210 |        |
|  | V <sub>GS</sub> = 5.0 V, I <sub>D</sub> = 0.5 A, T <sub>J</sub> = 25°C           |                                     |     | 105  | 120 |        |
|  | V <sub>GS</sub> = 5.0 V, I <sub>D</sub> = 0.5 A, T <sub>J</sub> = 150°C (Note 5) |                                     |     | 185  | 210 |        |
| Source-Drain Forward On Voltage        | V <sub>GS</sub> = 0 V, I <sub>S</sub> = 7.0 A                                    | V <sub>SD</sub>                     |     | 1.05 |     | V      |

## SWITCHING CHARACTERISTICS (Note 5)

|   |  |                                     |  |     |  |      |
|---|--|-------------------------------------|--|-----|--|------|
| Turn-ON Time (10% V <sub>IN</sub> to 90% I <sub>D</sub> )   | V <sub>GS</sub> = 10 V, V <sub>DD</sub> = 12 V<br>I <sub>D</sub> = 2.5 A, R <sub>L</sub> = 4.7 Ω | t <sub>ON</sub>                     |  | 20  |  | μs   |
| Turn-OFF Time (90% V <sub>IN</sub> to 10% I <sub>D</sub> )  |  | t <sub>OFF</sub>                    |  | 110 |  |      |
| Slew-Rate ON (70% V <sub>DS</sub> to 50% V <sub>DS</sub> )  | V <sub>GS</sub> = 10 V, V <sub>DD</sub> = 12 V,<br>R <sub>L</sub> = 4.7 Ω                        | -dV <sub>DS</sub> /dt <sub>ON</sub> |  | 1.0 |  | V/μs |
| Slew-Rate OFF (50% V <sub>DS</sub> to 70% V <sub>DS</sub> ) |  | dV <sub>DS</sub> /dt <sub>OFF</sub> |  | 0.4 |  |      |

## SELF PROTECTION CHARACTERISTICS (T<sub>J</sub> = 25°C unless otherwise noted) (Note 4)

|                              |  |                       |     |      |     |    |
|------------------------------|--|-----------------------|-----|------|-----|----|
| Current Limit                | V <sub>DS</sub> = 10 V, V <sub>GS</sub> = 5.0 V, T <sub>J</sub> = 25°C           | I <sub>LIM</sub>      | 6.0 | 9.0  | 11  | A  |
|                              | V <sub>DS</sub> = 10 V, V <sub>GS</sub> = 5.0 V, T <sub>J</sub> = 150°C (Note 5) |                       | 3.0 | 5.0  | 8.0 |    |
|                              | V <sub>DS</sub> = 10 V, V <sub>GS</sub> = 10 V, T <sub>J</sub> = 25°C            |                       | 7.0 | 10.5 | 13  |    |
|                              | V <sub>DS</sub> = 10 V, V <sub>GS</sub> = 10 V, T <sub>J</sub> = 150°C (Note 5)  |                       | 4.0 | 7.5  | 10  |    |
| Temperature Limit (Turn-off) | V <sub>GS</sub> = 5.0 V (Note 5)   | T <sub>LIM(off)</sub> | 150 | 180  | 200 | °C |
| Thermal Hysteresis           | V <sub>GS</sub> = 5.0 V  | ΔT <sub>LIM(on)</sub> |     | 15   |     |    |
| Temperature Limit (Turn-off) | V <sub>GS</sub> = 10 V (Note 5)  | T <sub>LIM(off)</sub> | 150 | 165  | 185 |    |
| Thermal Hysteresis           | V <sub>GS</sub> = 10 V   | ΔT <sub>LIM(on)</sub> |     | 15   |     |    |

## GATE INPUT CHARACTERISTICS (Note 5)

|  |  |                  |  |      |  |    |
|--|--|------------------|--|------|--|----|
| Device ON Gate Input Current           | V <sub>GS</sub> = 5 V, I <sub>D</sub> = 1.0 A  | I <sub>GON</sub> |  | 50   |  | μA |
|  | V <sub>GS</sub> = 10 V, I <sub>D</sub> = 1.0 A |                  |  | 400  |  |    |
| Current Limit Gate Input Current       | V <sub>GS</sub> = 5 V, V <sub>DS</sub> = 10 V  | I <sub>GCL</sub> |  | 0.05 |  | mA |
|  | V <sub>GS</sub> = 10 V, V <sub>DS</sub> = 10 V |                  |  | 0.4  |  |    |
| Thermal Limit Fault Gate Input Current | V <sub>GS</sub> = 5 V, V <sub>DS</sub> = 10 V  | I <sub>GTL</sub> |  | 0.22 |  | mA |
|  | V <sub>GS</sub> = 10 V, V <sub>DS</sub> = 10 V |                  |  | 1.0  |  |    |

## ESD ELECTRICAL CHARACTERISTICS (T<sub>J</sub> = 25°C unless otherwise noted) (Note 5)

|                                     |                        |     |      |  |  |   |
|-------------------------------------|------------------------|-----|------|--|--|---|
| Electro-Static Discharge Capability | Human Body Model (HBM) | ESD | 4000 |  |  | V |
|                                     | Machine Model (MM)     |     | 400  |  |  |   |

3. Pulse Test: Pulse Width ≤ 300 μs, Duty Cycle ≤ 2%.
4. Fault conditions are viewed as beyond the normal operating range of the part.
5. Not subject to production testing.

TYPICAL PERFORMANCE CURVES

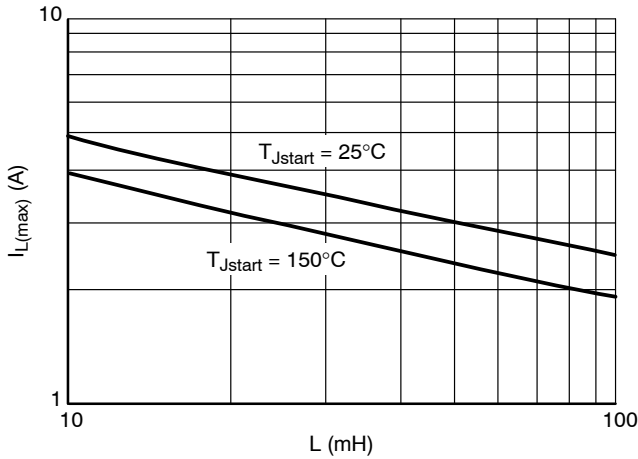

Figure 2. Single Pulse Maximum Switch-off Current vs. Load Inductance

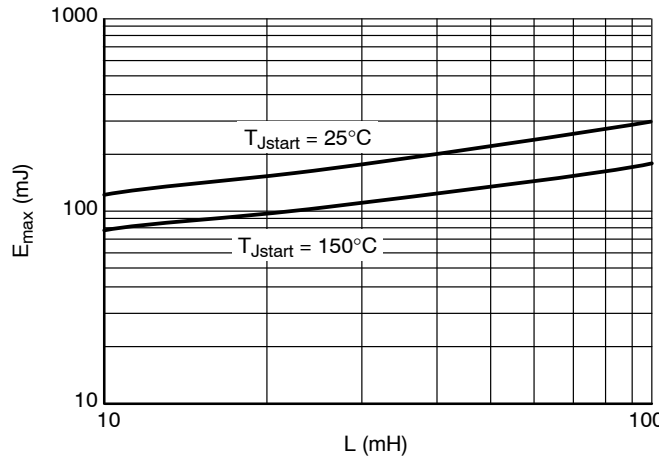

Figure 3. Single Pulse Maximum Switching Energy vs. Load Inductance

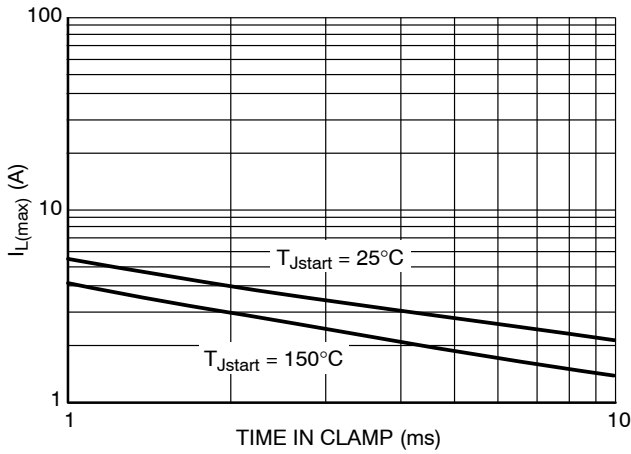

Figure 4. Single Pulse Maximum Inductive Switch-off Current vs. Time in Clamp

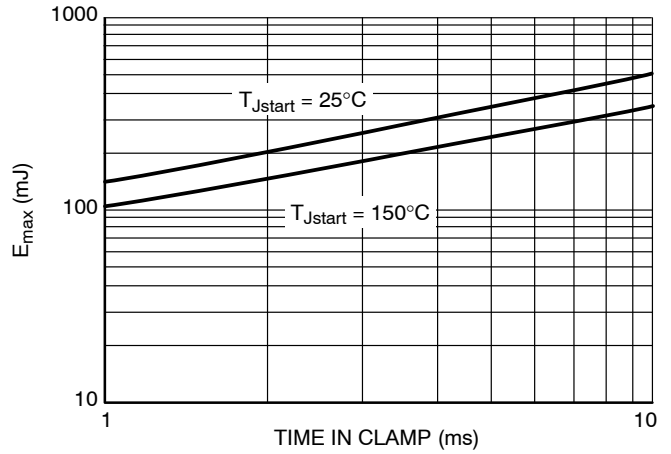

Figure 5. Single Pulse Maximum Inductive Switching Energy vs. Time in Clamp

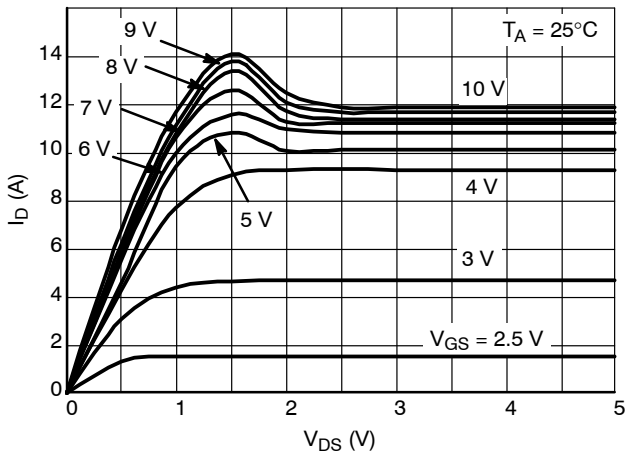

Figure 6. Output Characteristics

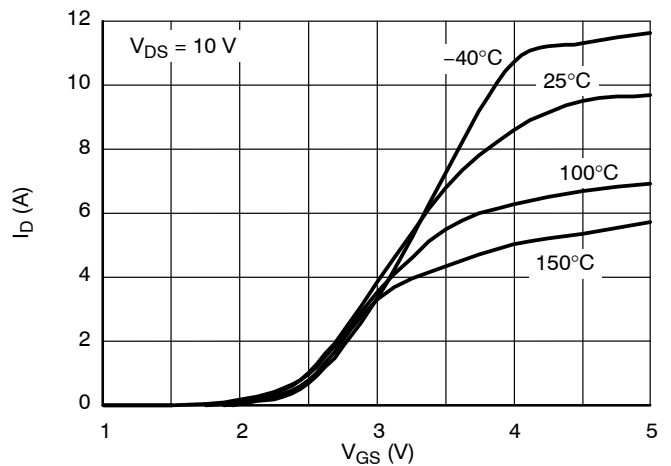

Figure 7. Transfer Characteristics

TYPICAL PERFORMANCE CURVES

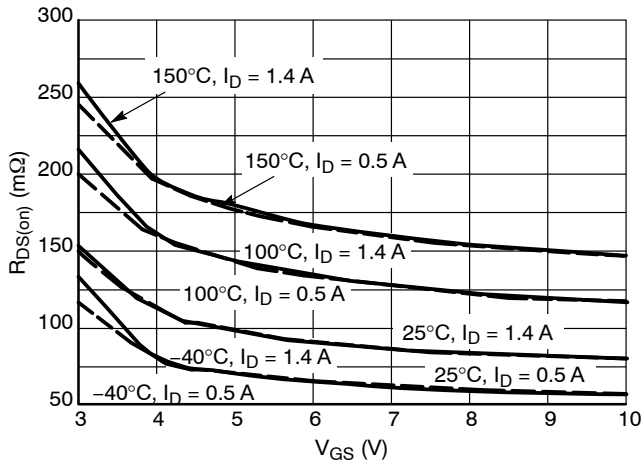

Figure 8.  $R_{DS(on)}$  vs. Gate-Source Voltage

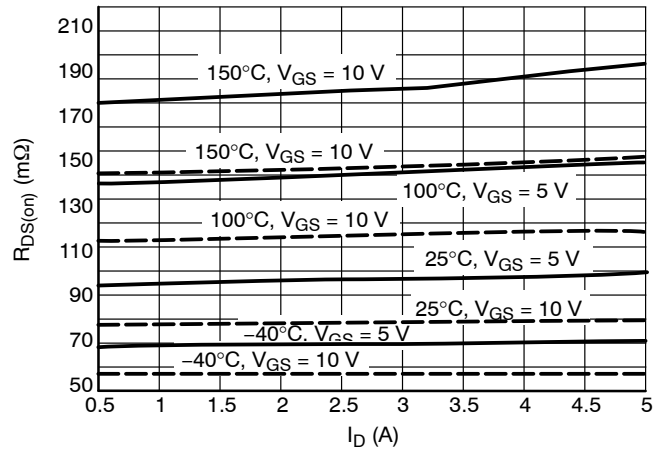

Figure 9.  $R_{DS(on)}$  vs. Drain Current

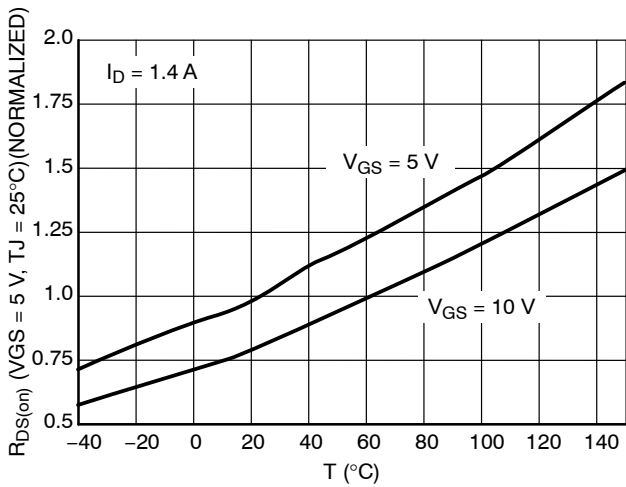

Figure 10. Normalized  $R_{DS(on)}$  vs. Temperature

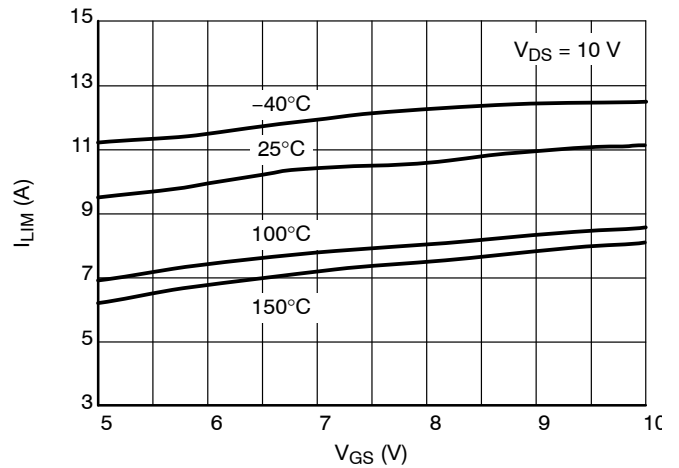

Figure 11. Current Limit vs. Gate-Source Voltage

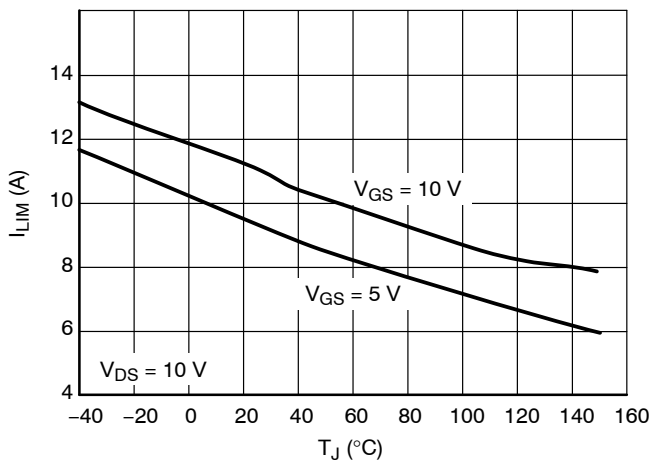

Figure 12. Current Limit vs. Junction Temperature

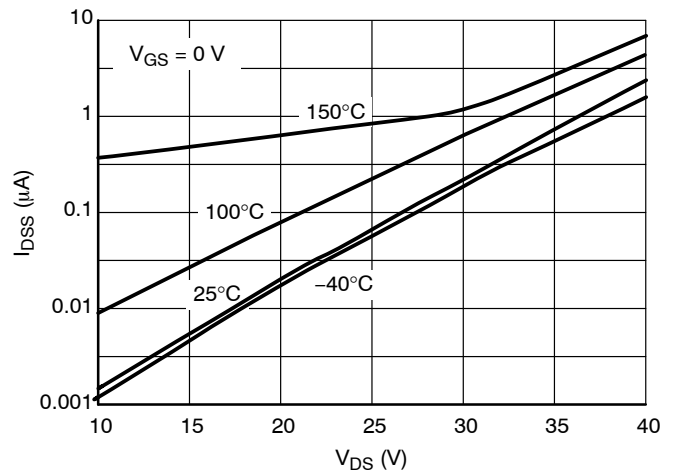

Figure 13. Drain-to-Source Leakage Current

TYPICAL PERFORMANCE CURVES

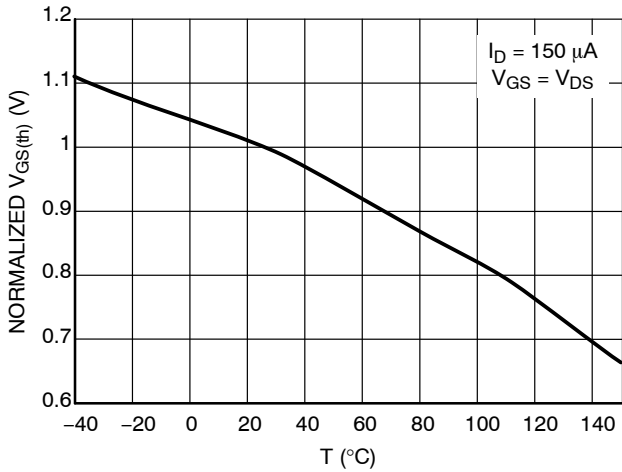

Figure 14. Normalized Threshold Voltage vs. Temperature

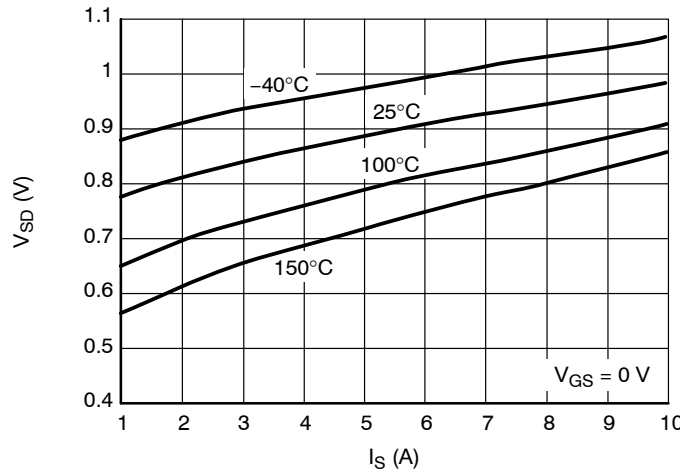

Figure 15. Body-Diode Forward Characteristics

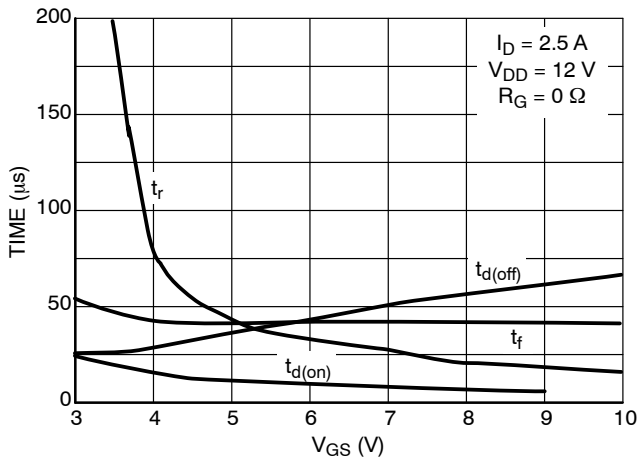

Figure 16. Resistive Load Switching Time vs. Gate-Source Voltage

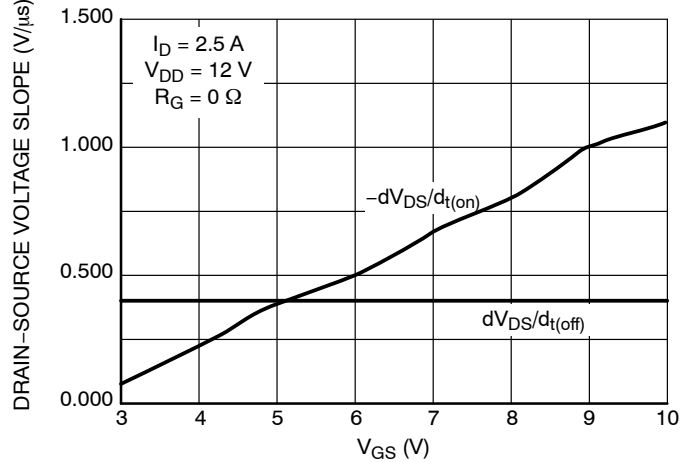

Figure 17. Resistive Load Switching Drain-Source Voltage Slope vs. Gate-Source Voltage

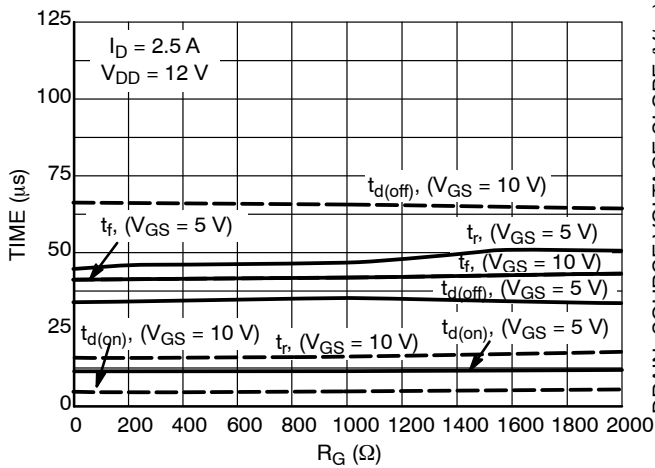

Figure 18. Resistive Load Switching Time vs. Gate Resistance

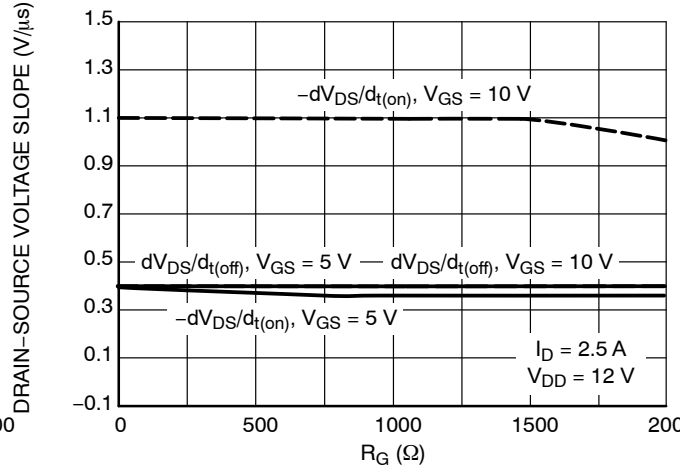

Figure 19. Drain-Source Voltage Slope during Turn On and Turn Off vs. Gate Resistance

# NCV8405A, NCV8405B

## TYPICAL PERFORMANCE CURVES

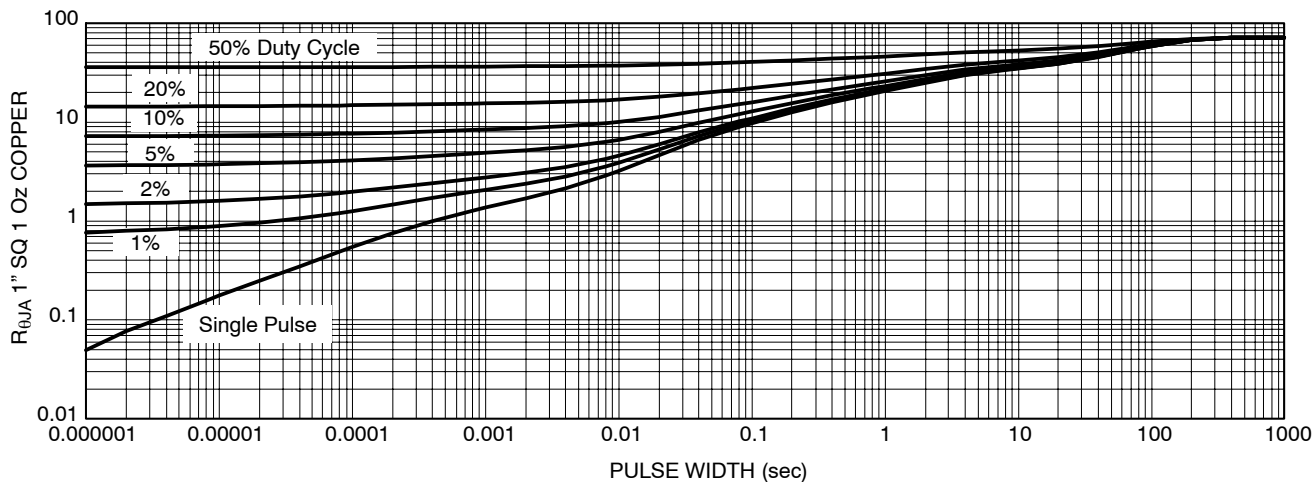

Figure 20. Transient Thermal Resistance

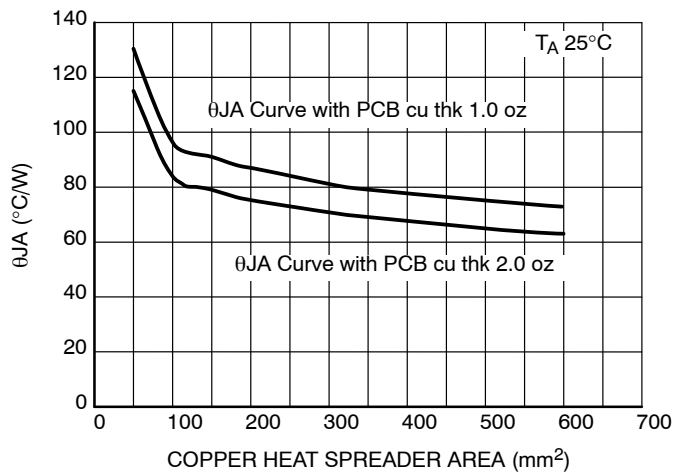

Figure 21.  $\theta_{JA}$  vs. Copper

# NCV8405A, NCV8405B

## TEST CIRCUITS AND WAVEFORMS



Figure 22. Resistive Load Switching Test Circuit

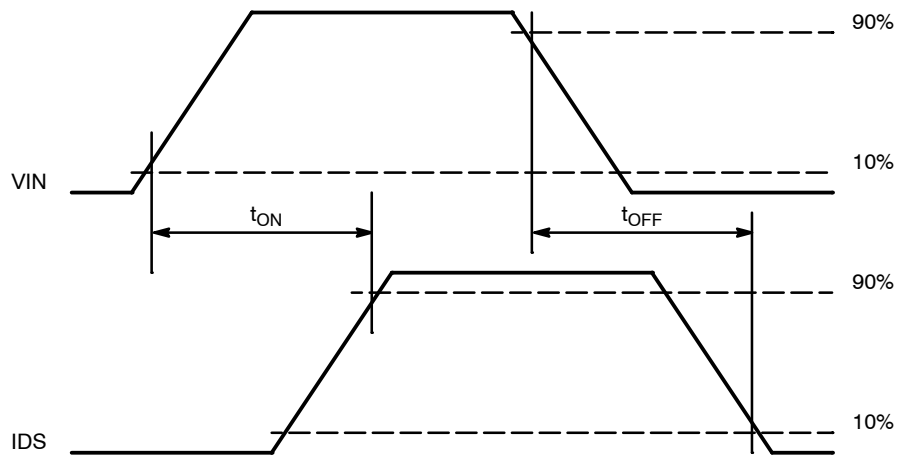

Figure 23. Resistive Load Switching Waveforms



# NCV8405A, NCV8405B

## TEST CIRCUITS AND WAVEFORMS

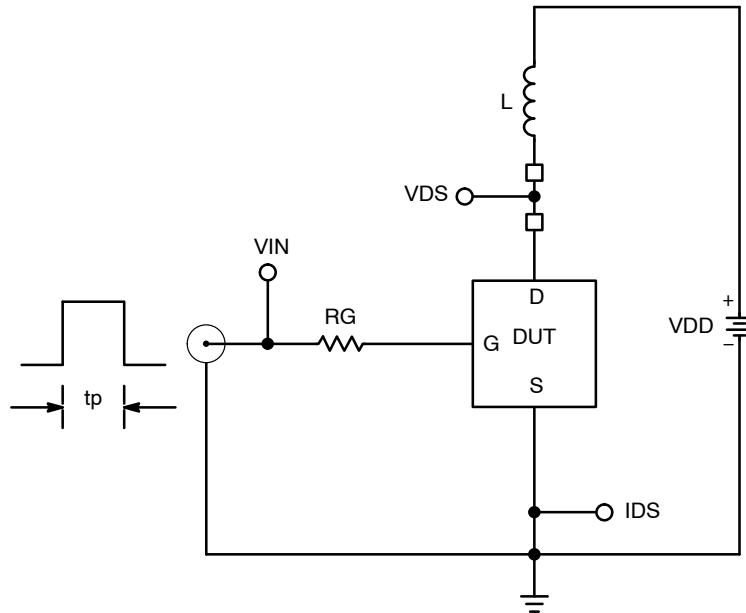

Figure 24. Inductive Load Switching Test Circuit



Figure 25. Inductive Load Switching Waveforms

# NCV8405A, NCV8405B

## ORDERING INFORMATION

| Device        | Package              | Shipping†          |
|---------------|----------------------|--------------------|
| NCV8405ASTT1G | SOT-223<br>(Pb-Free) | 1000 / Tape & Reel |
| NCV8405ASTT3G | SOT-223<br>(Pb-Free) | 4000 / Tape & Reel |
| NCV8405ADTRKG | DPAK<br>(Pb-Free)    | 2500 / Tape & Reel |
| NCV8405BDTRKG | DPAK<br>(Pb-Free)    | 2500 / Tape & Reel |

†For information on tape and reel specifications, including part orientation and tape sizes, please refer to our Tape and Reel Packaging Specifications Brochure, BRD8011/D.

# MECHANICAL CASE OUTLINE

## PACKAGE DIMENSIONS

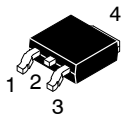

### DPAK (SINGLE GAUGE)

#### CASE 369C

#### ISSUE F

DATE 21 JUL 2015

SCALE 1:1

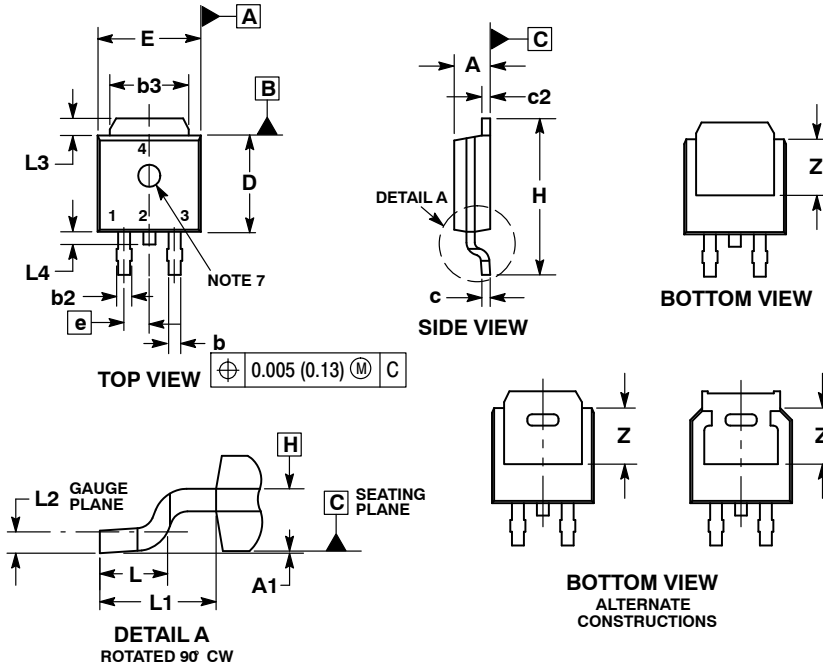

NOTES:

1. DIMENSIONING AND TOLERANCING PER ASME Y14.5M, 1994.
2. CONTROLLING DIMENSION: INCHES.
3. THERMAL PAD CONTOUR OPTIONAL WITHIN DIMENSIONS b3, L3 and Z.
4. DIMENSIONS D AND E DO NOT INCLUDE MOLD FLASH, PROTRUSIONS, OR BURRS. MOLD FLASH, PROTRUSIONS, OR GATE BURRS SHALL NOT EXCEED 0.006 INCHES PER SIDE.
5. DIMENSIONS D AND E ARE DETERMINED AT THE OUTERMOST EXTREMES OF THE PLASTIC BODY.
6. DATUMS A AND B ARE DETERMINED AT DATUM PLANE H.
7. OPTIONAL MOLD FEATURE.

| DIM | INCHES |       | MILLIMETERS |       |
|-----|--------|-------|-------------|-------|
|     | MIN    | MAX   | MIN         | MAX   |
| A   | 0.086  | 0.094 | 2.18        | 2.38  |
| A1  | 0.000  | 0.005 | 0.00        | 0.13  |
| b   | 0.025  | 0.035 | 0.63        | 0.89  |
| b2  | 0.028  | 0.045 | 0.72        | 1.14  |
| b3  | 0.180  | 0.215 | 4.57        | 5.46  |
| c   | 0.018  | 0.024 | 0.46        | 0.61  |
| c2  | 0.018  | 0.024 | 0.46        | 0.61  |
| D   | 0.235  | 0.245 | 5.97        | 6.22  |
| E   | 0.250  | 0.265 | 6.35        | 6.73  |
| e   | 0.090  | BSC   | 2.29        | BSC   |
| H   | 0.370  | 0.410 | 9.40        | 10.41 |
| L   | 0.055  | 0.070 | 1.40        | 1.78  |
| L1  | 0.114  | REF   | 2.90        | REF   |
| L2  | 0.020  | BSC   | 0.51        | BSC   |
| L3  | 0.035  | 0.050 | 0.89        | 1.27  |
| L4  | ---    | 0.040 | ---         | 1.01  |
| Z   | 0.155  | ---   | 3.93        | ---   |

### GENERIC MARKING DIAGRAM\*

- |  |  |   |   |  |
|--|--|---|---|--|
| <p>STYLE 1:<br/>PIN 1. BASE<br/>2. COLLECTOR<br/>3. EMITTER<br/>4. COLLECTOR</p> | <p>STYLE 2:<br/>PIN 1. GATE<br/>2. DRAIN<br/>3. SOURCE<br/>4. DRAIN</p>          | <p>STYLE 3:<br/>PIN 1. ANODE<br/>2. CATHODE<br/>3. ANODE<br/>4. CATHODE</p> | <p>STYLE 4:<br/>PIN 1. CATHODE<br/>2. ANODE<br/>3. GATE<br/>4. ANODE</p>              | <p>STYLE 5:<br/>PIN 1. GATE<br/>2. ANODE<br/>3. CATHODE<br/>4. ANODE</p>     |
| <p>STYLE 6:<br/>PIN 1. MT1<br/>2. MT2<br/>3. GATE<br/>4. MT2</p>                 | <p>STYLE 7:<br/>PIN 1. GATE<br/>2. COLLECTOR<br/>3. EMITTER<br/>4. COLLECTOR</p> | <p>STYLE 8:<br/>PIN 1. N/C<br/>2. CATHODE<br/>3. ANODE<br/>4. CATHODE</p>   | <p>STYLE 9:<br/>PIN 1. ANODE<br/>2. CATHODE<br/>3. RESISTOR ADJUST<br/>4. CATHODE</p> | <p>STYLE 10:<br/>PIN 1. CATHODE<br/>2. ANODE<br/>3. CATHODE<br/>4. ANODE</p> |

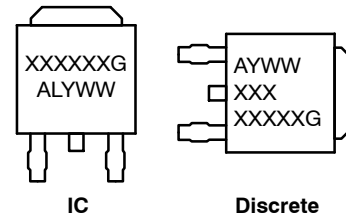

- XXXXXX = Device Code
- A = Assembly Location
- L = Wafer Lot
- Y = Year
- WW = Work Week
- G = Pb-Free Package

\*This information is generic. Please refer to device data sheet for actual part marking. Pb-Free indicator, "G" or microdot "•", may or may not be present. Some products may not follow the Generic Marking.

### SOLDERING FOOTPRINT\*

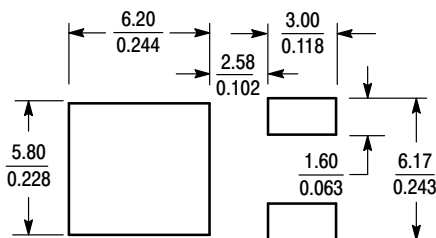

SCALE 3:1 (mm/inches)

\*For additional information on our Pb-Free strategy and soldering details, please download the ON Semiconductor Soldering and Mounting Techniques Reference Manual, SOLDERRM/D.

|                  |                     |  |
|------------------|---------------------|--|
| DOCUMENT NUMBER: | 98AON10527D         | Electronic versions are uncontrolled except when accessed directly from the Document Repository. Printed versions are uncontrolled except when stamped "CONTROLLED COPY" in red. |
| DESCRIPTION:     | DPAK (SINGLE GAUGE) | PAGE 1 OF 1  |

onsemi and ONSEMI are trademarks of Semiconductor Components Industries, LLC dba onsemi or its subsidiaries in the United States and/or other countries. onsemi reserves the right to make changes without further notice to any products herein. onsemi makes no warranty, representation or guarantee regarding the suitability of its products for any particular purpose, nor does onsemi assume any liability arising out of the application or use of any product or circuit, and specifically disclaims any and all liability, including without limitation special, consequential or incidental damages. onsemi does not convey any license under its patent rights nor the rights of others.

**onsemi**, **Onsemi**, and other names, marks, and brands are registered and/or common law trademarks of Semiconductor Components Industries, LLC dba "**onsemi**" or its affiliates and/or subsidiaries in the United States and/or other countries. **onsemi** owns the rights to a number of patents, trademarks, copyrights, trade secrets, and other intellectual property. A listing of **onsemi**'s product/patent coverage may be accessed at [www.onsemi.com/site/pdf/Patent-Marking.pdf](http://www.onsemi.com/site/pdf/Patent-Marking.pdf). **onsemi** reserves the right to make changes at any time to any products or information herein, without notice. The information herein is provided "as-is" and **onsemi** makes no warranty, representation or guarantee regarding the accuracy of the information, product features, availability, functionality, or suitability of its products for any particular purpose, nor does **onsemi** assume any liability arising out of the application or use of any product or circuit, and specifically disclaims any and all liability, including without limitation special, consequential or incidental damages. Buyer is responsible for its products and applications using **onsemi** products, including compliance with all laws, regulations and safety requirements or standards, regardless of any support or applications information provided by **onsemi**. "Typical" parameters which may be provided in **onsemi** data sheets and/or specifications can and do vary in different applications and actual performance may vary over time. All operating parameters, including "Typicals" must be validated for each customer application by customer's technical experts. **onsemi** does not convey any license under any of its intellectual property rights nor the rights of others. **onsemi** products are not designed, intended, or authorized for use as a critical component in life support systems or any FDA Class 3 medical devices or medical devices with a same or similar classification in a foreign jurisdiction or any devices intended for implantation in the human body. Should Buyer purchase or use **onsemi** products for any such unintended or unauthorized application, Buyer shall indemnify and hold **onsemi** and its officers, employees, subsidiaries, affiliates, and distributors harmless against all claims, costs, damages, and expenses, and reasonable attorney fees arising out of, directly or indirectly, any claim of personal injury or death associated with such unintended or unauthorized use, even if such claim alleges that **onsemi** was negligent regarding the design or manufacture of the part. **onsemi** is an Equal Opportunity/Affirmative Action Employer. This literature is subject to all applicable copyright laws and is not for resale in any manner.

## PUBLICATION ORDERING INFORMATION

### LITERATURE FULFILLMENT:

Email Requests to: [orderlit@onsemi.com](mailto:orderlit@onsemi.com)

**onsemi Website:** [www.onsemi.com](http://www.onsemi.com)

### TECHNICAL SUPPORT

**North American Technical Support:**

Voice Mail: 1 800-282-9855 Toll Free USA/Canada

Phone: 011 421 33 790 2910

**Europe, Middle East and Africa Technical Support:**

Phone: 00421 33 790 2910

For additional information, please contact your local Sales Representative