

**NOTES:**

1. Material : Stainless Steel
2. Finish : Glod Irridite
3. Ends : Closed and Ground
4. Total Coils : 10.000
5. Sugg. Max. Deflection : 3.700 (in)
6. Sugg. Max. Load : 2.300 (lbs)
7. All Drawing Dimensions are in Inches [mm]

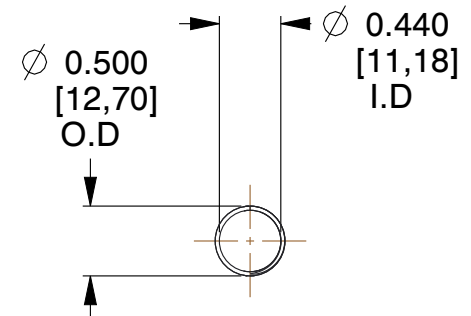
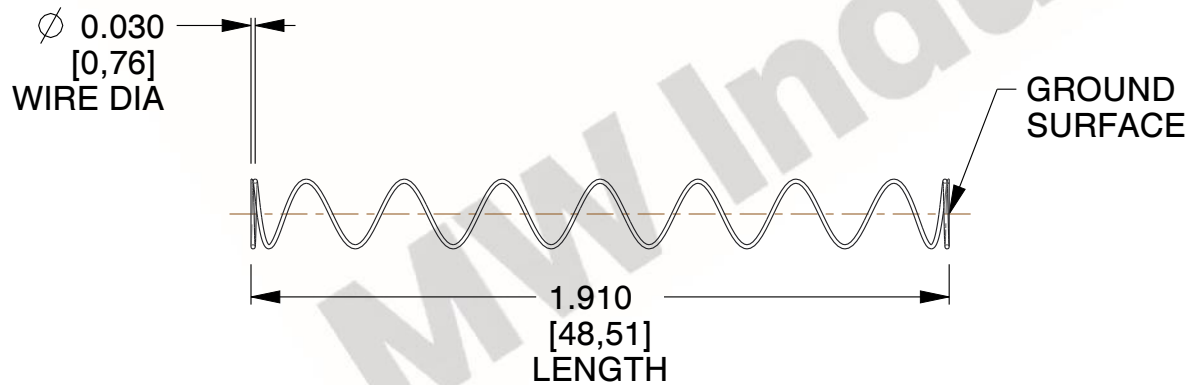

COMPONENT	SPRINGS
<b>11772</b>  COMPRESSION SPRINGS	UNIT
	INCH [mm]
	SHEET
	1 of 1