

# NST3906DXV6T1, NST3906DXV6T5

## Dual General Purpose Transistor

The NST3906DXV6T1 device is a spin-off of our popular SOT-23/SOT-323 three-leaded device. It is designed for general purpose amplifier applications and is housed in the SOT-563 six-leaded surface mount package. By putting two discrete devices in one package, this device is ideal for low-power surface mount applications where board space is at a premium.

- $h_{FE}$ , 100-300
- Low  $V_{CE(sat)}$ ,  $\leq 0.4$  V
- Simplifies Circuit Design
- Reduces Board Space
- Reduces Component Count
- Lead-Free Solder Plating

### MAXIMUM RATINGS

Rating	Symbol	Value	Unit
Collector- Emitter Voltage	$V_{CEO}$	-40	Vdc
Collector- Base Voltage	$V_{CBO}$	-40	Vdc
Emitter- Base Voltage	$V_{EBO}$	-5.0	Vdc
Collector Current - Continuous	$I_C$	-200	mAdc
Electrostatic Discharge	ESD	HBM>16000, MM>2000	V

### THERMAL CHARACTERISTICS

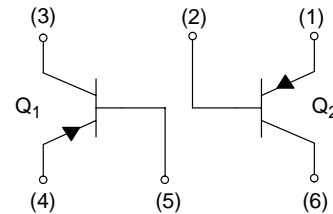
Characteristic (One Junction Heated)	Symbol	Max	Unit
Total Device Dissipation $T_A = 25^\circ\text{C}$ Derate above $25^\circ\text{C}$	$P_D$	357 (Note 1) 2.9 (Note 1)	mW mW/ $^\circ\text{C}$
Thermal Resistance Junction-to-Ambient	$R_{\theta JA}$	350 (Note 1)	$^\circ\text{C}/\text{W}$
Characteristic (Both Junctions Heated)	Symbol	Max	Unit
Total Device Dissipation $T_A = 25^\circ\text{C}$ Derate above $25^\circ\text{C}$	$P_D$	500 (Note 1) 4.0 (Note 1)	mW mW/ $^\circ\text{C}$
Thermal Resistance Junction-to-Ambient	$R_{\theta JA}$	250 (Note 1)	$^\circ\text{C}/\text{W}$
Junction and Storage Temperature Range	$T_J, T_{stg}$	- 55 to +150	$^\circ\text{C}$

1. FR-4 @ Minimum Pad

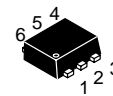


ON Semiconductor®

<http://onsemi.com>



NST3906DXV6T1



SOT-563  
CASE 463A  
PLASTIC

### MARKING DIAGRAM



A2 = Specific Device Code  
D = Date Code

### ORDERING INFORMATION

Device	Package	Shipping
NST3906DXV6T1	SOT-563	4 mm pitch 4000/Tape & Reel
NST3906DXV6T5	SOT-563	2 mm pitch 8000/Tape & Reel

# NST3906DXV6T1, NST3906DXV6T5

## ELECTRICAL CHARACTERISTICS (T<sub>A</sub> = 25°C unless otherwise noted)

Characteristic	Symbol	Min	Max	Unit
----------------	--------	-----	-----	------

### OFF CHARACTERISTICS

Collector - Emitter Breakdown Voltage (Note 2)	V <sub>(BR)CEO</sub>	-40	-	Vdc
Collector - Base Breakdown Voltage	V <sub>(BR)CBO</sub>	-40	-	Vdc
Emitter - Base Breakdown Voltage	V <sub>(BR)EBO</sub>	-5.0	-	Vdc
Base Cutoff Current	I <sub>BL</sub>	-	-50	nAdc
Collector Cutoff Current	I <sub>CEX</sub>	-	-50	nAdc

### ON CHARACTERISTICS (Note 2)

DC Current Gain (I <sub>C</sub> = -0.1 mAdc, V <sub>CE</sub> = -1.0 Vdc) (I <sub>C</sub> = -1.0 mAdc, V <sub>CE</sub> = -1.0 Vdc) (I <sub>C</sub> = -10 mAdc, V <sub>CE</sub> = -1.0 Vdc) (I <sub>C</sub> = -50 mAdc, V <sub>CE</sub> = -1.0 Vdc) (I <sub>C</sub> = -100 mAdc, V <sub>CE</sub> = -1.0 Vdc)	h <sub>FE</sub>	60 80 100 60 30	- - 300 - -	- - - - -
Collector - Emitter Saturation Voltage (I <sub>C</sub> = -10 mAdc, I <sub>B</sub> = -1.0 mAdc) (I <sub>C</sub> = -50 mAdc, I <sub>B</sub> = -5.0 mAdc)	V <sub>CE(sat)</sub>	- -	-0.25 -0.4	Vdc
Base - Emitter Saturation Voltage (I <sub>C</sub> = -10 mAdc, I <sub>B</sub> = -1.0 mAdc) (I <sub>C</sub> = -50 mAdc, I <sub>B</sub> = -5.0 mAdc)	V <sub>BE(sat)</sub>	-0.65 -	-0.85 -0.95	Vdc

### SMALL- SIGNAL CHARACTERISTICS

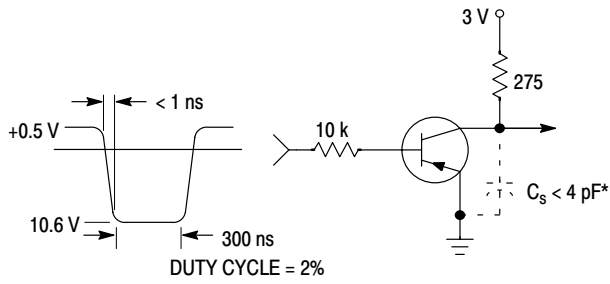
Current - Gain - Bandwidth Product	f <sub>T</sub>	250	-	MHz
Output Capacitance	C <sub>obo</sub>	-	4.5	pF
Input Capacitance	C <sub>ibo</sub>	-	10.0	pF
Input Impedance (V <sub>CE</sub> = -10 Vdc, I <sub>C</sub> = -1.0 mAdc, f = 1.0 kHz)	h <sub>ie</sub>	2.0	12	k Ω
Voltage Feedback Ratio (V <sub>CE</sub> = -10 Vdc, I <sub>C</sub> = -1.0 mAdc, f = 1.0 kHz)	h <sub>re</sub>	0.1	10	X 10 <sup>-4</sup>
Small - Signal Current Gain (V <sub>CE</sub> = -10 Vdc, I <sub>C</sub> = -1.0 mAdc, f = 1.0 kHz)	h <sub>fe</sub>	100	400	-
Output Admittance (V <sub>CE</sub> = -10 Vdc, I <sub>C</sub> = -1.0 mAdc, f = 1.0 kHz)	h <sub>oe</sub>	3.0	60	μmhos
Noise Figure (V <sub>CE</sub> = -5.0 Vdc, I <sub>C</sub> = -100 μAdc, R <sub>S</sub> = 1.0 k Ω, f = 1.0 kHz)	NF	-	4.0	dB

### SWITCHING CHARACTERISTICS

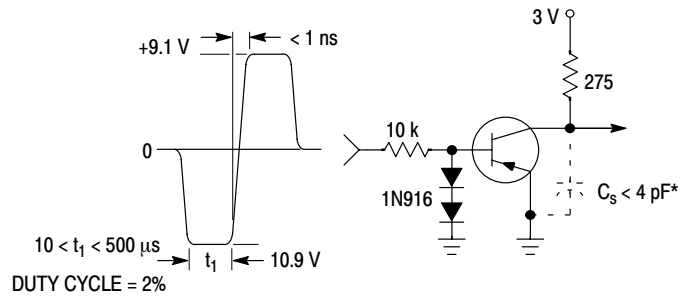
Delay Time (V <sub>CC</sub> = -3.0 Vdc, V <sub>BE</sub> = 0.5 Vdc)	t <sub>d</sub>	-	35	ns
Rise Time (I <sub>C</sub> = -10 mAdc, I <sub>B1</sub> = -1.0 mAdc)	t <sub>r</sub>	-	35	
Storage Time (V <sub>CC</sub> = -3.0 Vdc, I <sub>C</sub> = -10 mAdc)	t <sub>s</sub>	-	225	ns
Fall Time (I <sub>B1</sub> = I <sub>B2</sub> = -1.0 mAdc)	t <sub>f</sub>	-	75	

2. Pulse Test: Pulse Width ≤ 300 μs; Duty Cycle ≤ 2.0%.

# NST3906DXV6T1, NST3906DXV6T5



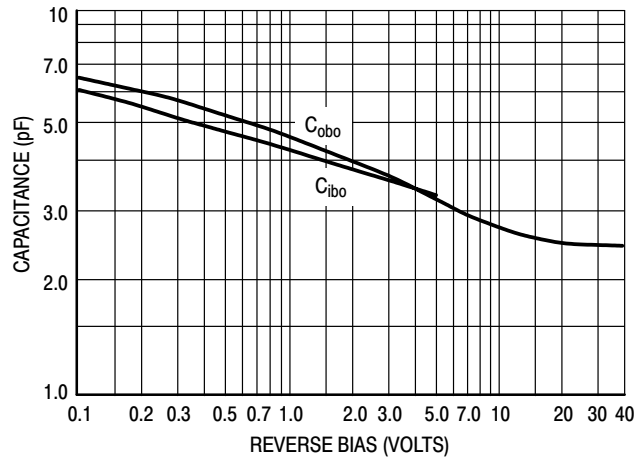
**Figure 1. Delay and Rise Time Equivalent Test Circuit**



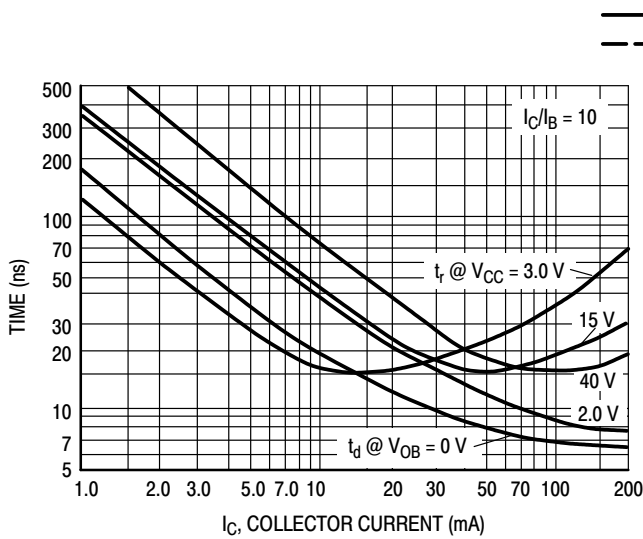
**Figure 2. Storage and Fall Time Equivalent Test Circuit**

\* Total shunt capacitance of test jig and connectors

## TYPICAL TRANSIENT CHARACTERISTICS

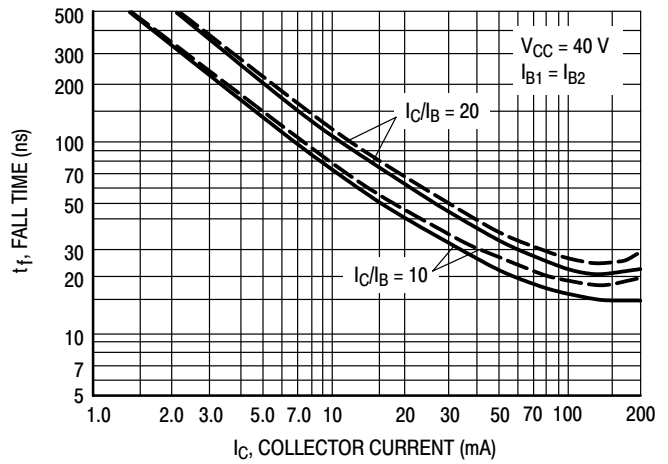


**Figure 3. Capacitance**



**Figure 4. Turn-On Time**

—  $T_J = 25^\circ\text{C}$   
 - - -  $T_J = 125^\circ\text{C}$



**Figure 5. Fall Time**

# NST3906DXV6T1, NST3906DXV6T5

## TYPICAL AUDIO SMALL-SIGNAL CHARACTERISTICS NOISE FIGURE VARIATIONS

( $V_{CE} = -5.0$  Vdc,  $T_A = 25^\circ\text{C}$ , Bandwidth = 1.0 Hz)

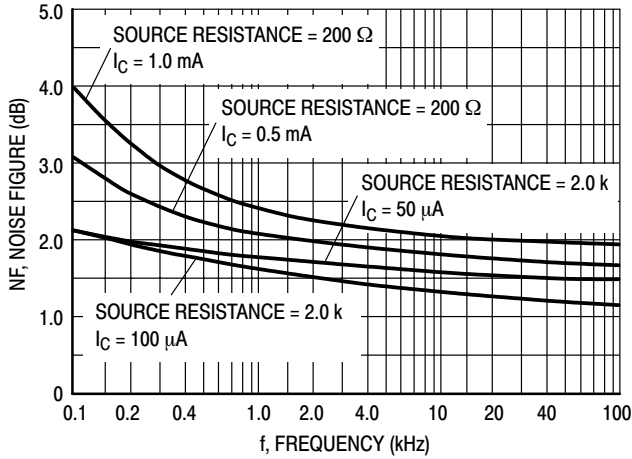


Figure 6.

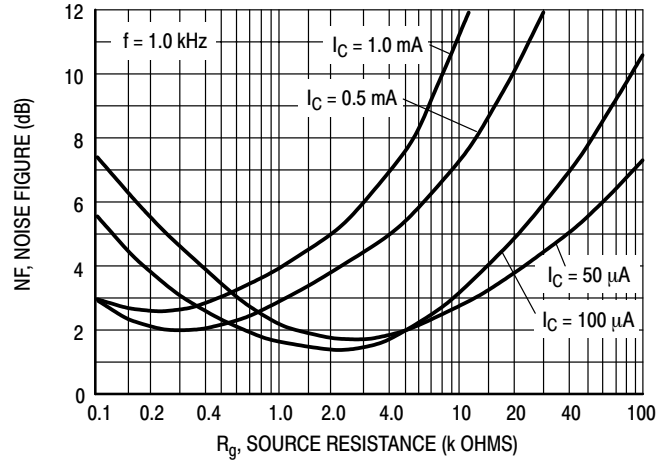


Figure 7.

## h PARAMETERS

( $V_{CE} = -10$  Vdc,  $f = 1.0$  kHz,  $T_A = 25^\circ\text{C}$ )

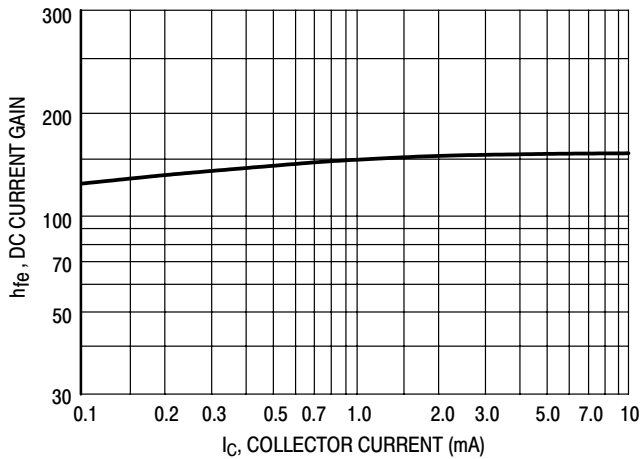


Figure 8. Current Gain

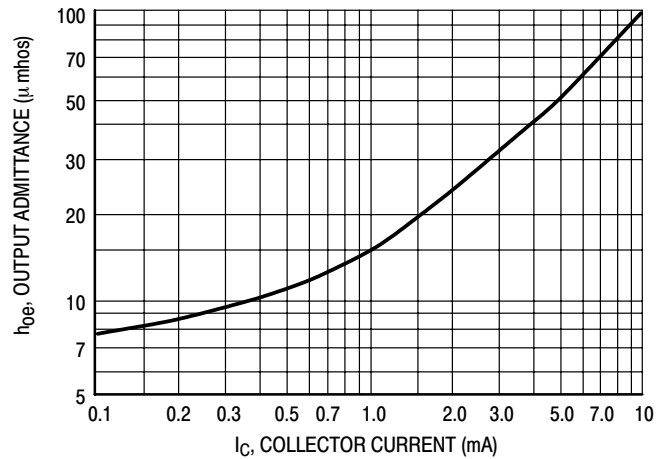


Figure 9. Output Admittance

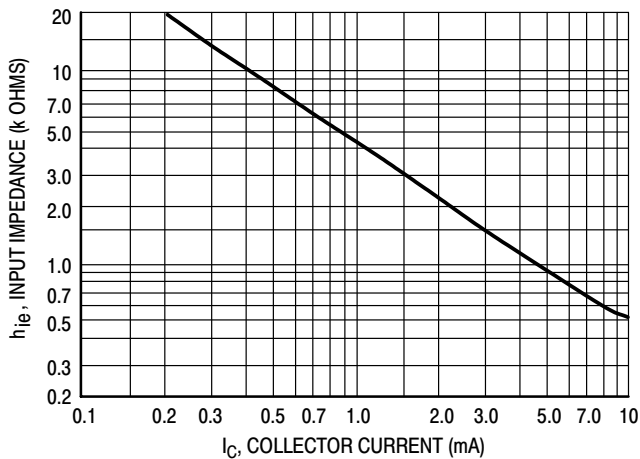


Figure 10. Input Impedance

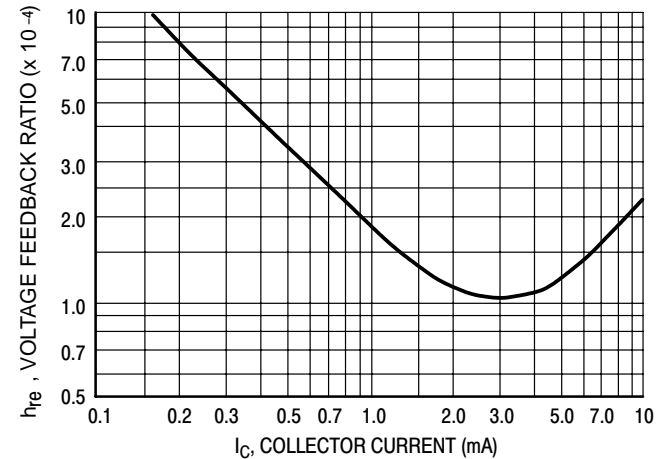


Figure 11. Voltage Feedback Ratio

# NST3906DXV6T1, NST3906DXV6T5

## TYPICAL STATIC CHARACTERISTICS

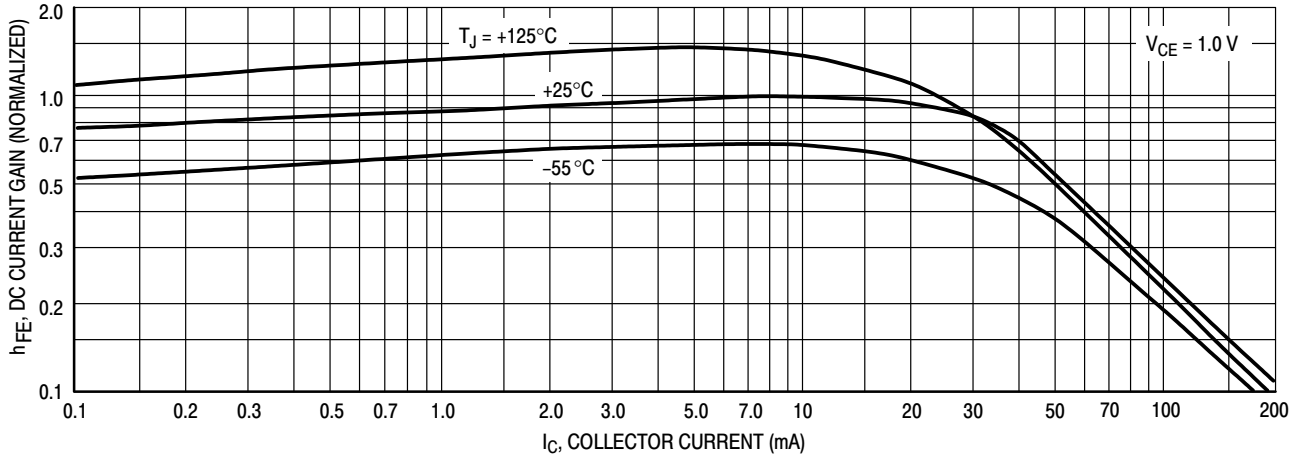


Figure 12. DC Current Gain

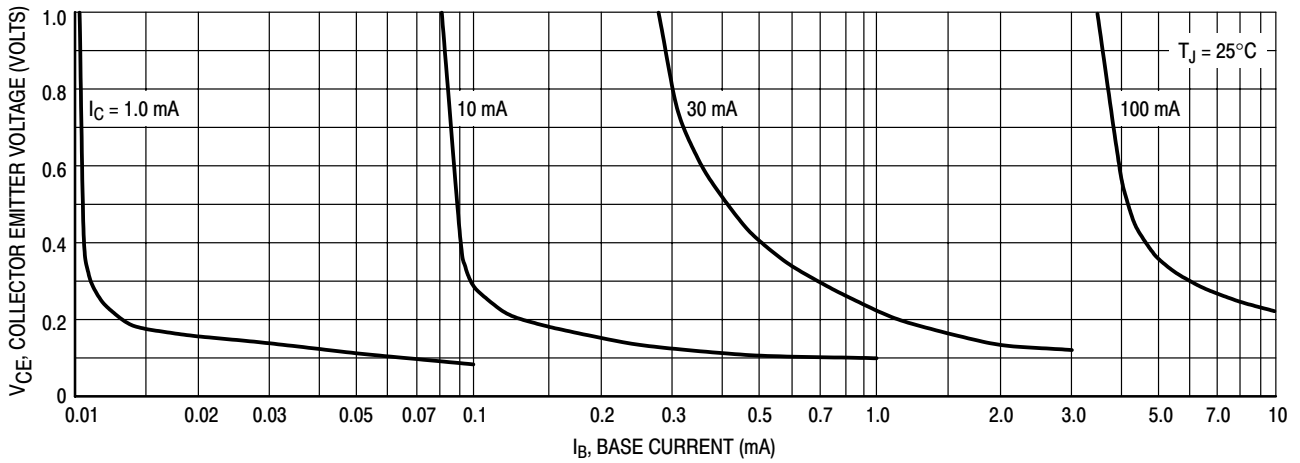


Figure 13. Collector Saturation Region

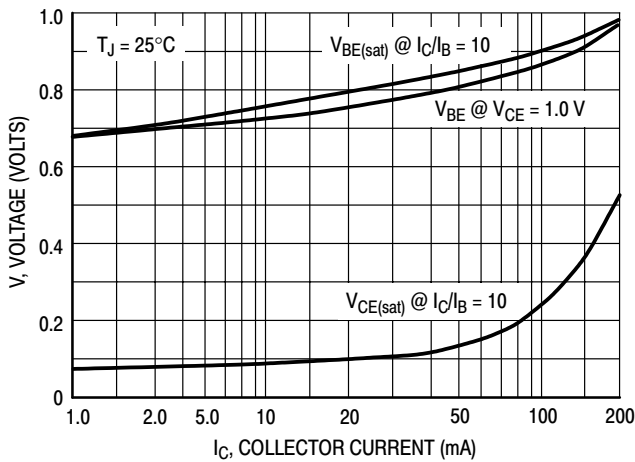


Figure 14. "ON" Voltages

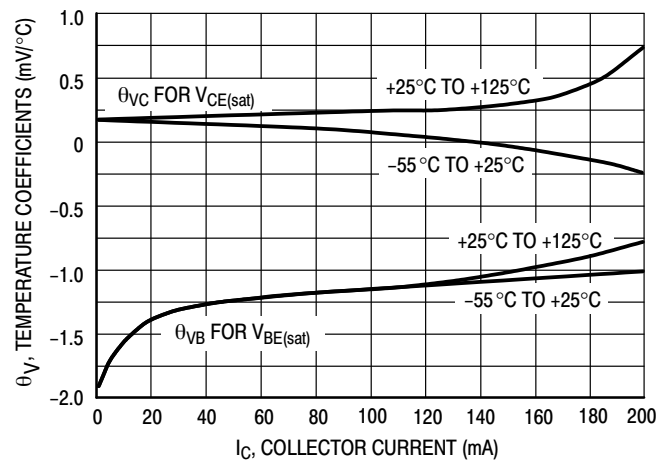
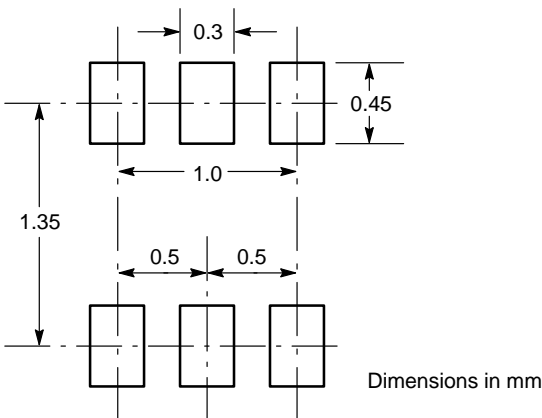


Figure 15. Temperature Coefficients

**INFORMATION FOR USING THE SOT-563 SURFACE MOUNT PACKAGE**  
**MINIMUM RECOMMENDED FOOTPRINT FOR SURFACE MOUNTED APPLICATIONS**

Surface mount board layout is a critical portion of the total design. The footprint for the semiconductor packages must be the correct size to insure proper solder connection

interface between the board and the package. With the correct pad geometry, the packages will self align when subjected to a solder reflow process.



**SOT-563**

**SOT-563 POWER DISSIPATION**

The power dissipation of the SOT-563 is a function of the pad size. This can vary from the minimum pad size for soldering to a pad size given for maximum power dissipation. Power dissipation for a surface mount device is determined by  $T_{J(max)}$ , the maximum rated junction temperature of the die,  $R_{\theta JA}$ , the thermal resistance from the device junction to ambient, and the operating temperature,  $T_A$ . Using the values provided on the data sheet for the SOT-563 package,  $P_D$  can be calculated as follows:

$$P_D = \frac{T_{J(max)} - T_A}{R_{\theta JA}}$$

The values for the equation are found in the maximum ratings table on the data sheet. Substituting these values into the equation for an ambient temperature  $T_A$  of 25°C, one can calculate the power dissipation of the device which in this case is 150 milliwatts.

$$P_D = \frac{150^\circ\text{C} - 25^\circ\text{C}}{833^\circ\text{C/W}} = 150 \text{ milliwatts}$$

The 833°C/W for the SOT-563 package assumes the use of the recommended footprint on a glass epoxy printed circuit board to achieve a power dissipation of 150 milliwatts. There are other alternatives to achieving higher power dissipation from the SOT-563 package. Another alternative would be to use a ceramic substrate or an aluminum core board such as Thermal Clad®. Using a board material such as Thermal Clad, an aluminum core board, the power dissipation can be doubled using the same footprint.

Thermal Clad is a registered trademark of the Bergquist Company.

**SOLDERING PRECAUTIONS**

The melting temperature of solder is higher than the rated temperature of the device. When the entire device is heated to a high temperature, failure to complete soldering within a short time could result in device failure. Therefore, the following items should always be observed in order to minimize the thermal stress to which the devices are subjected.

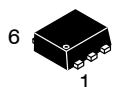
- Always preheat the device.
- The delta temperature between the preheat and soldering should be 100°C or less.\*
- When preheating and soldering, the temperature of the leads and the case must not exceed the maximum temperature ratings as shown on the data sheet. When using infrared heating with the reflow soldering method, the difference shall be a maximum of 10°C.
- The soldering temperature and time shall not exceed 260°C for more than 10 seconds.
- When shifting from preheating to soldering, the maximum temperature gradient shall be 5°C or less.
- After soldering has been completed, the device should be allowed to cool naturally for at least three minutes. Gradual cooling should be used as the use of forced cooling will increase the temperature gradient and result in latent failure due to mechanical stress.
- Mechanical stress or shock should not be applied during cooling.

\* Soldering a device without preheating can cause excessive thermal shock and stress which can result in damage to the device

# MECHANICAL CASE OUTLINE

## PACKAGE DIMENSIONS

ON Semiconductor®



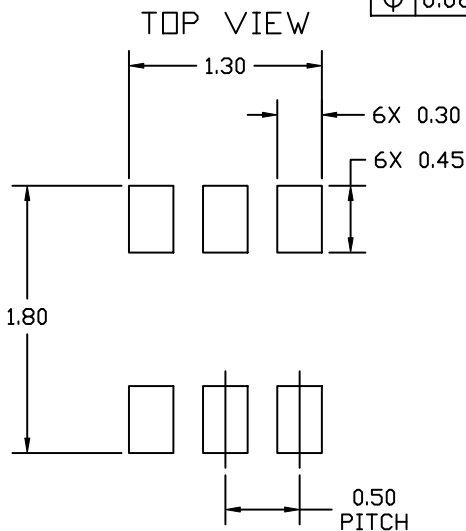
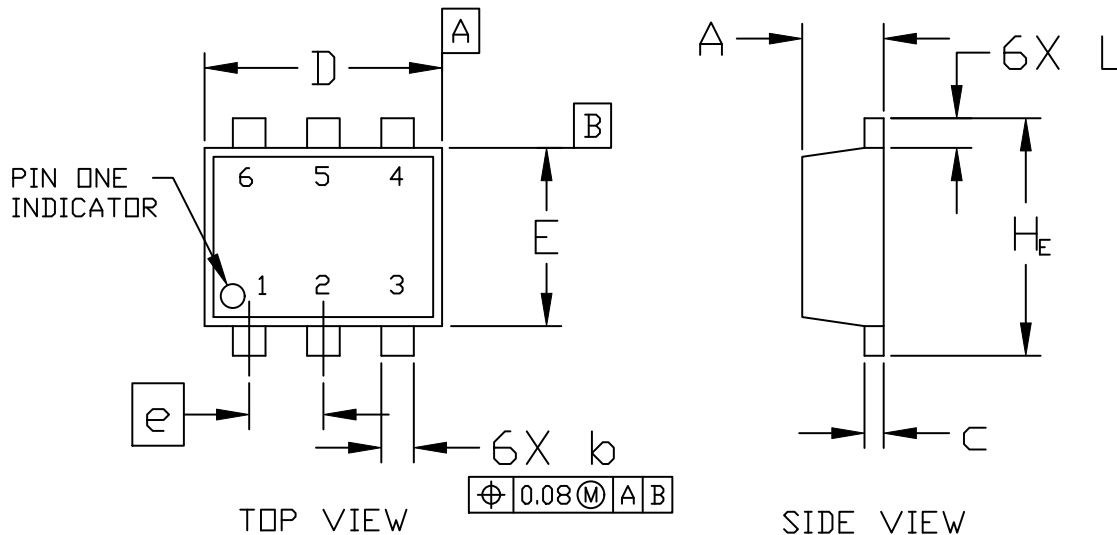
SCALE 4:1

**SOT-563, 6 LEAD**  
CASE 463A  
ISSUE H

DATE 26 JAN 2021

**NOTES:**

1. DIMENSIONING AND TOLERANCING PER ASME Y14.5M, 2009.
2. CONTROLLING DIMENSION: MILLIMETERS
3. MAXIMUM LEAD THICKNESS INCLUDES LEAD FINISH THICKNESS. MINIMUM LEAD THICKNESS IS THE MINIMUM THICKNESS OF BASE MATERIAL.



DIM	MILLIMETERS		
	MIN.	NOM.	MAX.
A	0.50	0.55	0.60
b	0.17	0.22	0.27
c	0.08	0.13	0.18
D	1.50	1.60	1.70
E	1.10	1.20	1.30
e	0.50 BSC		
L	0.10	0.20	0.30
H <sub>E</sub>	1.50	1.60	1.70

**RECOMMENDED MOUNTING FOOTPRINT\***

\* For additional information on our Pb-Free strategy and soldering details, please download the ON Semiconductor Soldering and Mounting Techniques Reference Manual, SOLDERRM/D.

<b>DOCUMENT NUMBER:</b>	<b>98AON11126D</b>	Electronic versions are uncontrolled except when accessed directly from the Document Repository. Printed versions are uncontrolled except when stamped "CONTROLLED COPY" in red.
<b>DESCRIPTION:</b>	<b>SOT-563, 6 LEAD</b>	<b>PAGE 1 OF 2</b>

ON Semiconductor and are trademarks of Semiconductor Components Industries, LLC dba ON Semiconductor or its subsidiaries in the United States and/or other countries. ON Semiconductor reserves the right to make changes without further notice to any products herein. ON Semiconductor makes no warranty, representation or guarantee regarding the suitability of its products for any particular purpose, nor does ON Semiconductor assume any liability arising out of the application or use of any product or circuit, and specifically disclaims any and all liability, including without limitation special, consequential or incidental damages. ON Semiconductor does not convey any license under its patent rights nor the rights of others.

**SOT-563, 6 LEAD**  
CASE 463A  
ISSUE H

DATE 26 JAN 2021

STYLE 1:  
PIN 1. EMITTER 1  
2. BASE 1  
3. COLLECTOR 2  
4. EMITTER 2  
5. BASE 2  
6. COLLECTOR 1

STYLE 2:  
PIN 1. EMITTER 1  
2. EMITTER 2  
3. BASE 2  
4. COLLECTOR 2  
5. BASE 1  
6. COLLECTOR 1

STYLE 3:  
PIN 1. CATHODE 1  
2. CATHODE 1  
3. ANODE/ANODE 2  
4. CATHODE 2  
5. CATHODE 2  
6. ANODE/ANODE 1

STYLE 4:  
PIN 1. COLLECTOR  
2. COLLECTOR  
3. BASE  
4. EMITTER  
5. COLLECTOR  
6. COLLECTOR

STYLE 5:  
PIN 1. CATHODE  
2. CATHODE  
3. ANODE  
4. ANODE  
5. CATHODE  
6. CATHODE

STYLE 6:  
PIN 1. CATHODE  
2. ANODE  
3. CATHODE  
4. CATHODE  
5. CATHODE  
6. CATHODE

STYLE 7:  
PIN 1. CATHODE  
2. ANODE  
3. CATHODE  
4. CATHODE  
5. ANODE  
6. CATHODE

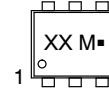
STYLE 8:  
PIN 1. DRAIN  
2. DRAIN  
3. GATE  
4. SOURCE  
5. DRAIN  
6. DRAIN

STYLE 9:  
PIN 1. SOURCE 1  
2. GATE 1  
3. DRAIN 2  
4. SOURCE 2  
5. GATE 2  
6. DRAIN 1

STYLE 10:  
PIN 1. CATHODE 1  
2. N/C  
3. CATHODE 2  
4. ANODE 2  
5. N/C  
6. ANODE 1

STYLE 11:  
PIN 1. EMITTER 2  
2. BASE 2  
3. COLLECTOR 1  
4. EMITTER 1  
5. BASE 1  
6. COLLECTOR 2

**GENERIC  
MARKING DIAGRAM\***



XX = Specific Device Code  
M = Month Code  
■ = Pb-Free Package

\*This information is generic. Please refer to device data sheet for actual part marking. Pb-Free indicator, "G" or microdot "■", may or may not be present. Some products may not follow the Generic Marking.

<b>DOCUMENT NUMBER:</b>	<b>98AON11126D</b>	Electronic versions are uncontrolled except when accessed directly from the Document Repository. Printed versions are uncontrolled except when stamped "CONTROLLED COPY" in red.
<b>DESCRIPTION:</b>	<b>SOT-563, 6 LEAD</b>	<b>PAGE 2 OF 2</b>

ON Semiconductor and are trademarks of Semiconductor Components Industries, LLC dba ON Semiconductor or its subsidiaries in the United States and/or other countries. ON Semiconductor reserves the right to make changes without further notice to any products herein. ON Semiconductor makes no warranty, representation or guarantee regarding the suitability of its products for any particular purpose, nor does ON Semiconductor assume any liability arising out of the application or use of any product or circuit, and specifically disclaims any and all liability, including without limitation special, consequential or incidental damages. ON Semiconductor does not convey any license under its patent rights nor the rights of others.



**onsemi**, **Onsemi**, and other names, marks, and brands are registered and/or common law trademarks of Semiconductor Components Industries, LLC dba "**onsemi**" or its affiliates and/or subsidiaries in the United States and/or other countries. **onsemi** owns the rights to a number of patents, trademarks, copyrights, trade secrets, and other intellectual property. A listing of **onsemi**'s product/patent coverage may be accessed at [www.onsemi.com/site/pdf/Patent-Marking.pdf](http://www.onsemi.com/site/pdf/Patent-Marking.pdf). **onsemi** reserves the right to make changes at any time to any products or information herein, without notice. The information herein is provided "as-is" and **onsemi** makes no warranty, representation or guarantee regarding the accuracy of the information, product features, availability, functionality, or suitability of its products for any particular purpose, nor does **onsemi** assume any liability arising out of the application or use of any product or circuit, and specifically disclaims any and all liability, including without limitation special, consequential or incidental damages. Buyer is responsible for its products and applications using **onsemi** products, including compliance with all laws, regulations and safety requirements or standards, regardless of any support or applications information provided by **onsemi**. "Typical" parameters which may be provided in **onsemi** data sheets and/or specifications can and do vary in different applications and actual performance may vary over time. All operating parameters, including "Typicals" must be validated for each customer application by customer's technical experts. **onsemi** does not convey any license under any of its intellectual property rights nor the rights of others. **onsemi** products are not designed, intended, or authorized for use as a critical component in life support systems or any FDA Class 3 medical devices or medical devices with a same or similar classification in a foreign jurisdiction or any devices intended for implantation in the human body. Should Buyer purchase or use **onsemi** products for any such unintended or unauthorized application, Buyer shall indemnify and hold **onsemi** and its officers, employees, subsidiaries, affiliates, and distributors harmless against all claims, costs, damages, and expenses, and reasonable attorney fees arising out of, directly or indirectly, any claim of personal injury or death associated with such unintended or unauthorized use, even if such claim alleges that **onsemi** was negligent regarding the design or manufacture of the part. **onsemi** is an Equal Opportunity/Affirmative Action Employer. This literature is subject to all applicable copyright laws and is not for resale in any manner.

## PUBLICATION ORDERING INFORMATION

### LITERATURE FULFILLMENT:

Email Requests to: [orderlit@onsemi.com](mailto:orderlit@onsemi.com)

**onsemi Website:** [www.onsemi.com](http://www.onsemi.com)

### TECHNICAL SUPPORT

**North American Technical Support:**

Voice Mail: 1 800-282-9855 Toll Free USA/Canada

Phone: 011 421 33 790 2910

**Europe, Middle East and Africa Technical Support:**

Phone: 00421 33 790 2910

For additional information, please contact your local Sales Representative