

SUMMARY



Image is for illustrative purpose only

Wires

Coax 1

Series 0A
Termination type Female solder
IP rating 50
AWG wire size 0.00 - 0.00
Cable Ø 0.00 - 0.00 mm
Status active

Download

[Request a quote](#)

[Catalog](#)

TECHNICAL DETAILS

Mechanics

Shell Style/Model ERN*: Fixed receptacle with tag, nut fixing
Keying
Housing Material Brass (nickel plated [SAE AMS QQ N 290]) shell, collet nut, latch sleeve and mid pieces
Weight 4.28 g

Performance

Configuration 0A.275 : 1 Coax (75 Ohm)
Insulator
Rated Current

Specifications

Contact Type: Coaxial 75 Ohm (Solder)

Others

Endurance (Shell): 5000 mating cycles
Salt Spray Corrosion: >144 hr

LEMO products and services are provided "as is". LEMO makes no warranties or representations with regard to LEMO product & services or use of them, express, implied or statutory, including for accuracy, completeness, or security. The user is fully responsible for his products and applications using LEMO components.

DRAWINGS

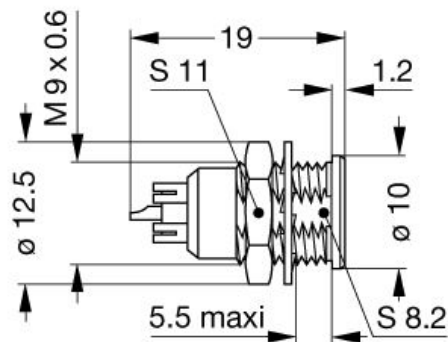





Dimensions

| | A | B | E _{max} | L | M | S1 | S2 | e1 |
|-----|------|------|------------------|------|------|------|------|--------|
| mm. | 10 | 12.5 | 5.5 | 19 | 1.2 | 8.2 | 11 | M9x0.6 |
| in. | 0,39 | 0,49 | 0,22 | 0,75 | 0,05 | 0,32 | 0,43 | |



RECOMMENDED BY LEMO

Tools

Cables

| | | | |
|--------|-----------|-------|--|
| 159580 | PVC | Black | |
| 17420 | PVC | Black |  |
| 17450 | COPOLYMER | Black |  |
| 178190 | PTFE | Brown | |
| 18000 | PTFE | Brown |  |
| 18700 | PTFE | White |  |
| 18800 | PTFE | White | |
| 196270 | PTFE | White | |
| 31600 | PTFE | Brown | |
| 62000 | PVC | Black | |

LEMO products and services are provided "as is". LEMO makes no warranties or representations with regard to LEMO product & services or use of them, express, implied or statutory, including for accuracy, completeness, or security. The user is fully responsible for his products and applications using LEMO components.

| | | | |
|---------------------|------|-------|--|
| CCX.50.030.083.180B | | White | |
| CCX.50.RG0.58AU14B | FEP | White | |
| CCX.50.RG1.74-U25N | PVC | Black | |
| CCX.50.RG1.74AU28N | PVC | Black | |
| CCX.50.RG1.74AU28N | PVC | Black |  |
| CCX.50.RG1.74U25N | PVC | Black | |
| CCX.50.RG1.78BU18M | FEP | Brown | |
| CCX.50.RG1.78BU18M | PTFE | Brown | |
| CCX.50.RG1.88AU24B | TFE | White | |
| CCX.50.RG1.88AU26B | PFA | White | |
| CCX.50.RG1.88AU26B | PTFE | White | |
| CCX.50.RG1.96AU19B | PTFE | White | |
| CCX.50.RG1.96AU20B | PFA | White | |
| CCX.50.RG3.16BU26M | FEP | Brown | |
| CCX.50.RG3.16U28M | PTFE | Brown | |
| CCX.75.040.195327G | PVC | Grey | |
| CCX.75.RG0.59BU62N | PVC | Black | |
| CCX.75.RG1.79BU26M | FEP | Brown | |
| CCX.75.RG1.87AU26B | PFA | White | |
| CCX.75.RG1.87AU27B | PTFE | White |  |
| CCX.93.RG0.62AU62N | PVC | Black | |
| CCX.95.RG1.80BU36M | PTFE | Brown |  |
| CCX.95.RG1.95AU37B | PFA | White | |

LEMO products and services are provided "as is". LEMO makes no warranties or representations with regard to LEMO product & services or use of them, express, implied or statutory, including for accuracy, completeness, or security. The user is fully responsible for his products and applications using LEMO components.