

Build Your Own Clone Envelope Filter & Fixed Wah Kit Instructions

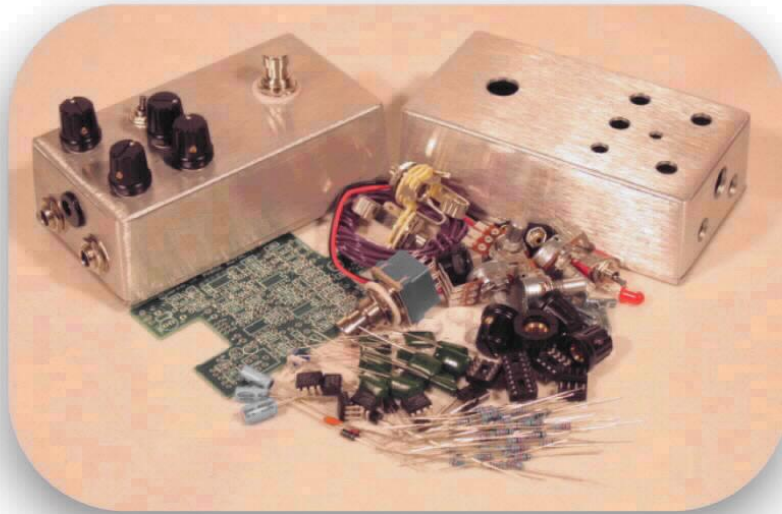

Warranty:

BYOC, LLC guarantees that your kit will be complete and that all parts and components will arrive as described, functioning and free of defect. Soldering, clipping, cutting, stripping, or using any of the components in any way voids this guarantee. BYOC, LLC guarantees that the instructions for your kit will be free of any major errors that would cause you to permanently damage any components in your kit, but does not guarantee that the instructions will be free of typos or minor errors. BYOC, LLC does not warranty the completed pedal as a whole functioning unit nor do we warranty any of the individual parts once they have been used. If you have a component that is used, but feel it was defective prior to you using it, we reserve the right to determine whether or not the component was faulty upon arrival. Please direct all warranty issues to: sales@buildyourownclone.com This would include any missing parts issues.

Return:

BYOC, LLC accepts returns and exchanges on all products for any reason, as long as they are unused. We do not accept partial kit returns. Returns and exchanges are for the full purchase price less the cost of shipping and/or any promotional pricing. Return shipping is the customer's responsibility. This responsibility not only includes the cost of shipping, but accountability of delivery as well. Please contact sales@buildyourownclone.com to receive a return authorization before mailing.

Tech Support:

BYOC, LLC makes no promises or guarantees that you will successfully complete your kit in a satisfactory manner. Nor does BYOC, LLC promise or guarantee that you will receive any technical support. Purchasing a product from BYOC, LLC does not entitle you to any amount of technical support. BYOC, LLC does not promise or guarantee that any technical support you may receive will be able to resolve any or all issues you may be experiencing.

That being said, we will do our best to help you as much as we can. Our philosophy at BYOC is that we will help you only as much as you are willing to help yourself. We have a wonderful and friendly DIY discussion forum with an entire section devoted to the technical support and modifications of BYOC kits.

www.buildyourownclone.com/board

When posting a tech support thread on the BYOC forum, please post it in the correct lounge, and please title your thread appropriately. If everyone titles their threads "HELP!", then it makes it impossible for the people who are helping you to keep track of your progress. A very brief description of your specific problem will do. It will also make it easier to see if someone else is having or has had the same problem as you. The question you are about to ask may already be answered. Here are a list of things that you should include in the body of your tech support thread:

1. A detailed explanation of what the problem is. (not just, "It doesn't work, help")
2. Pic of the top side of your PCB.
3. Pic of the underside of your PCB.
4. Pic that clearly shows your footswitch/jack wiring and the wires going to the PCB
5. A pic that clearly shows your wiring going from the PCB to the pots and any other switches(only if your kit has non-PC mounted pots and switches)
6. Is bypass working?
7. Does the LED come on?
8. If you answer yes to 6 and 7, what does the pedal do when it is "on"?
9. Battery or adapter.(if battery, is it good? If adapter, what type?)

Also, please only post pics that are in focus. You're only wasting both parties' time if you post out of focus, low res pics from your cell phone.

Revision Notes:

Rev 1.0 - Error in PCB that causes bypass tone loss. The circuit output and off-board wiring to the out jack are connected.

Rev 1.1 - no known errors

For older envelope filter kit instructions go to:

www.buildyourownclone.com/oldfilter.pdf

Copyrights:

All material in this document is copyrighted 2010 by BYOC, LLC

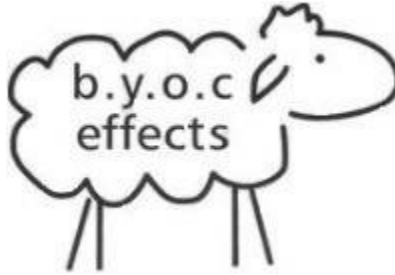

**ENVELOPE FILTER & FIXED WAH
KIT
INSTRUCTION INDEX**

PCB fix (rev1.0 only).....page 4

Parts Checklist.....page 5 - 6

Populating the Circuit Board.....page 7 - 15

Main PCB Assembly.....page 16 - 18

Wiring.....page 19 - 22

Installing the IC's and Finishing Up.....page 23

Operation Overview.....page 24 - 25

Schematic.....page 26 - 27

PCB Fix (for rev 1.0 only!)

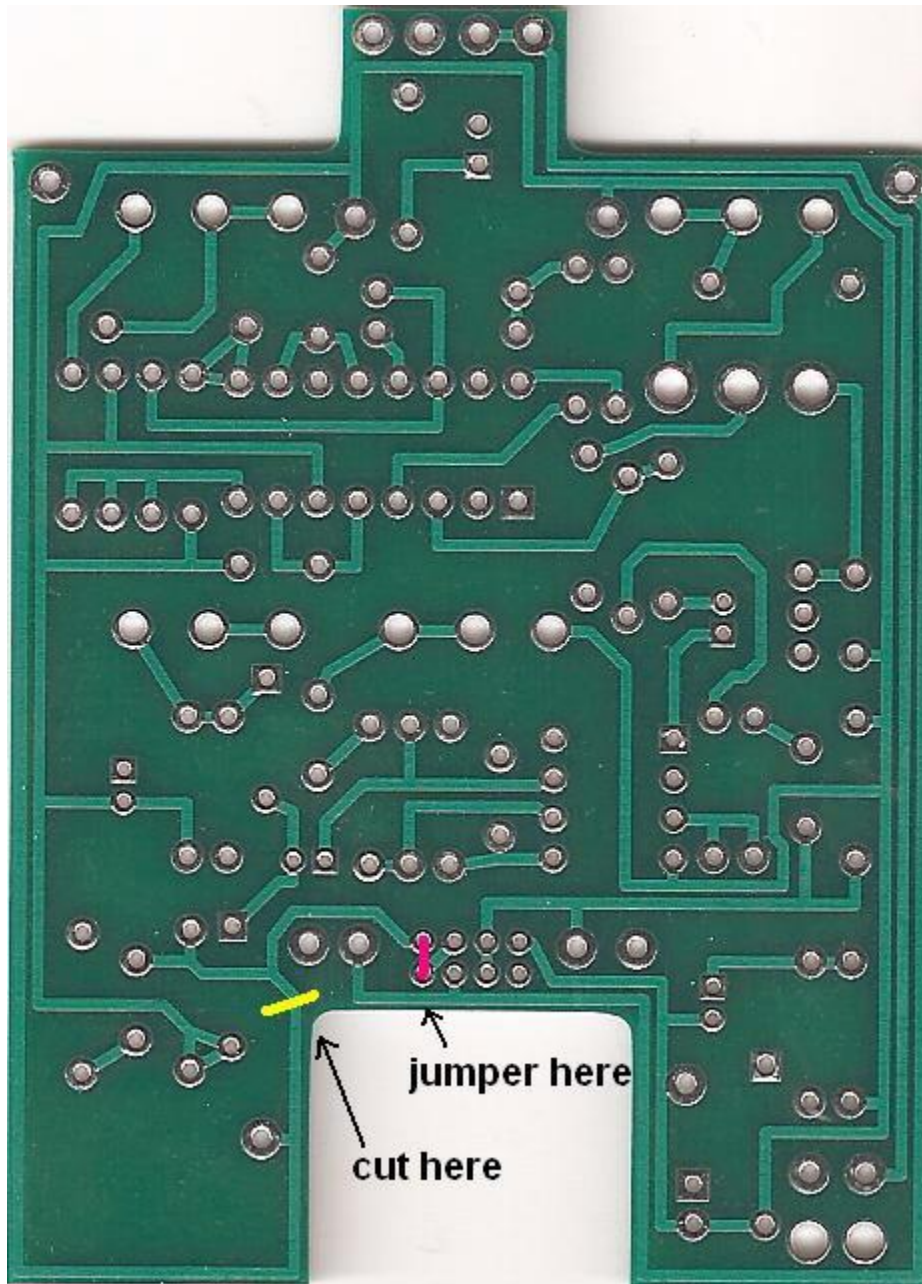

There is an error in the Rev 1.0 pcb. If you have a Rev 1.1 pcb or higher, you do not need to do anything to your pcb.

1. Using a razor blade, utility knife, or an awl, cut the trace on the underside of the pcb along the yellow line.
2. Using a small piece of clipping from one of the components, make a jumper along the red line, connecting the two eyelets. This jumper can be made on either the top or bottom side of the pcb. The eyelets are labelled "7" and "8" on the top side.

Parts Checklist for BYOC Envelope Filter & Fixed Wah

Resistors:

- 5 - 1k (brown/black/black/brown/brown)
- 1 - 4k7 (yellow/purple/black/brown/brown)
- 5 - 10k (brown/black/black/red/brown)
- 9 - 22k (red/red/black/red/brown)
- 1 - 100k (brown/black/black/orange/brown)
- 2 - 150k (brown/green/black/orange/brown)
- 3 - 1M (brown/black/black/yellow/brown)

Capacitors:

- 1 - 1n0 or .001 μ film (102)
- 3 - 10n or .01 μ film (103)
- 1 - 47n or .047 μ film (473)
- 2 - 100n or .1 μ film (104 or μ 1)
- 4 - 4.7 μ f aluminum electrolytic
- 1 - 100 μ f aluminum electrolytic

Diodes:

- 1 - 1N4001 (black plastic with silver stripe)
- 2 - 1N4148 (small orange glass with black stripe)

Transistors:

- 1 - 2N5088, 2N3904, or 2N2222

IC's:

- 1 - 4558, TL072 or other dual op amp
- 1 - JRC13600, JRC13700, LM13600, V13700, or other dual transconductance op amp
- 1 - 8 pin socket
- 1 - 16 pin socket

Potentiometers: Be sure to snap off the small tab on the side of each panel mounted pot.

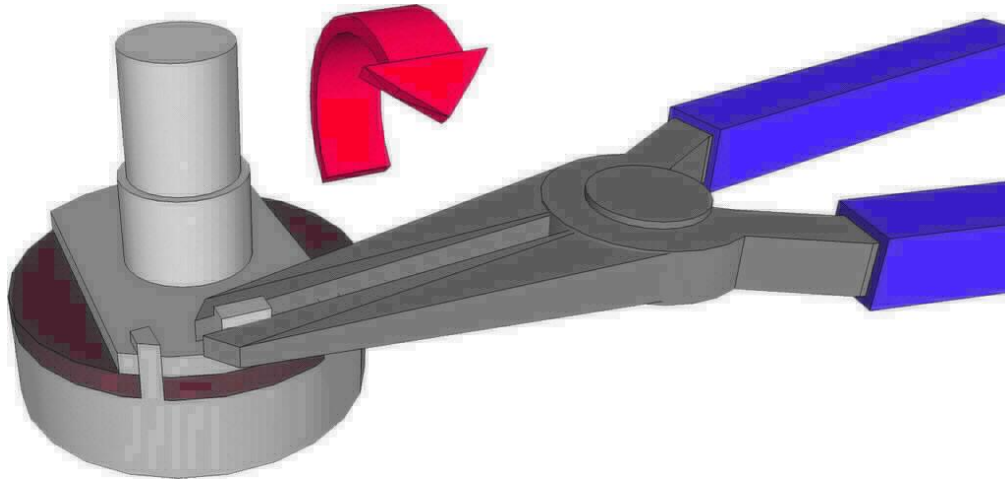

- 2 - B100k linear (Range and Attack knobs)
- 1 - C250k reverse audio (Sensitivity knob)
- 1 - A100k audio (Manual knob)

Hardware:

- 1 - drilled enclosure w/ 4 screws
- 1 - byoc envelope filter & fixed wah pcb
- 1 - SPDT toggle switch
- 1 - 3PDT footswitch
- 4 - knobs
- 1 - AC adaptor jack
- 1 - 1/4" mono jack
- 1 - 1/4" stereo jack
- 1 - red LED
- 1 - battery snap
- 4 - bumpers
- hook-up wire

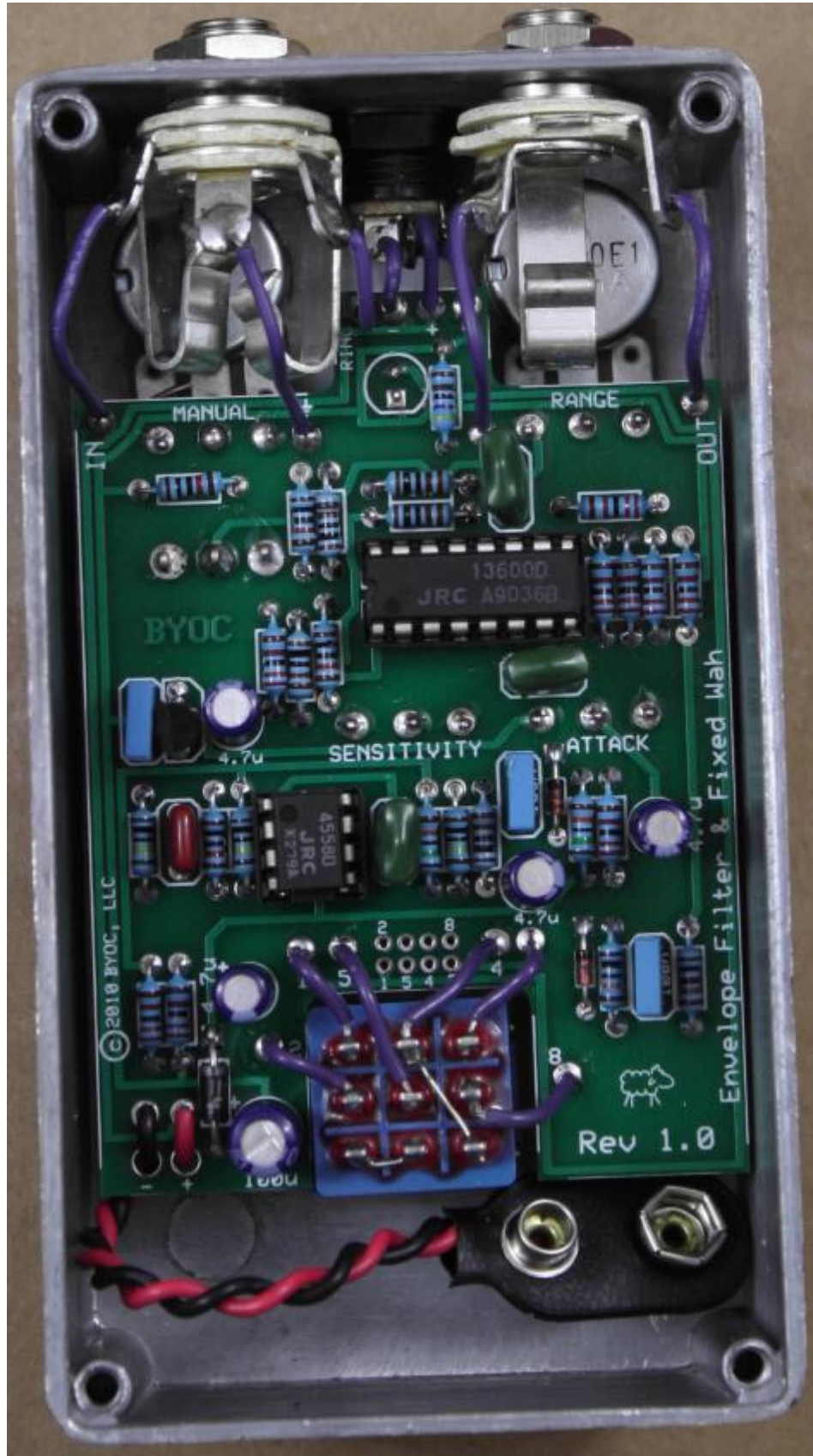

© 2018 BYOC, LLC

MANUAL

RANGE

IN

OUT

BYOC

SENSITIVITY

ATTACK

4.7u

4.7u

4.7u

4.7u

100u

Rev 1.0

Envelope Filter & Fixed Wah



1 2 3 4 5 6 7 8

8

5

4

3

2

1

0E1

RTN

+

-

Populating the Circuit Board

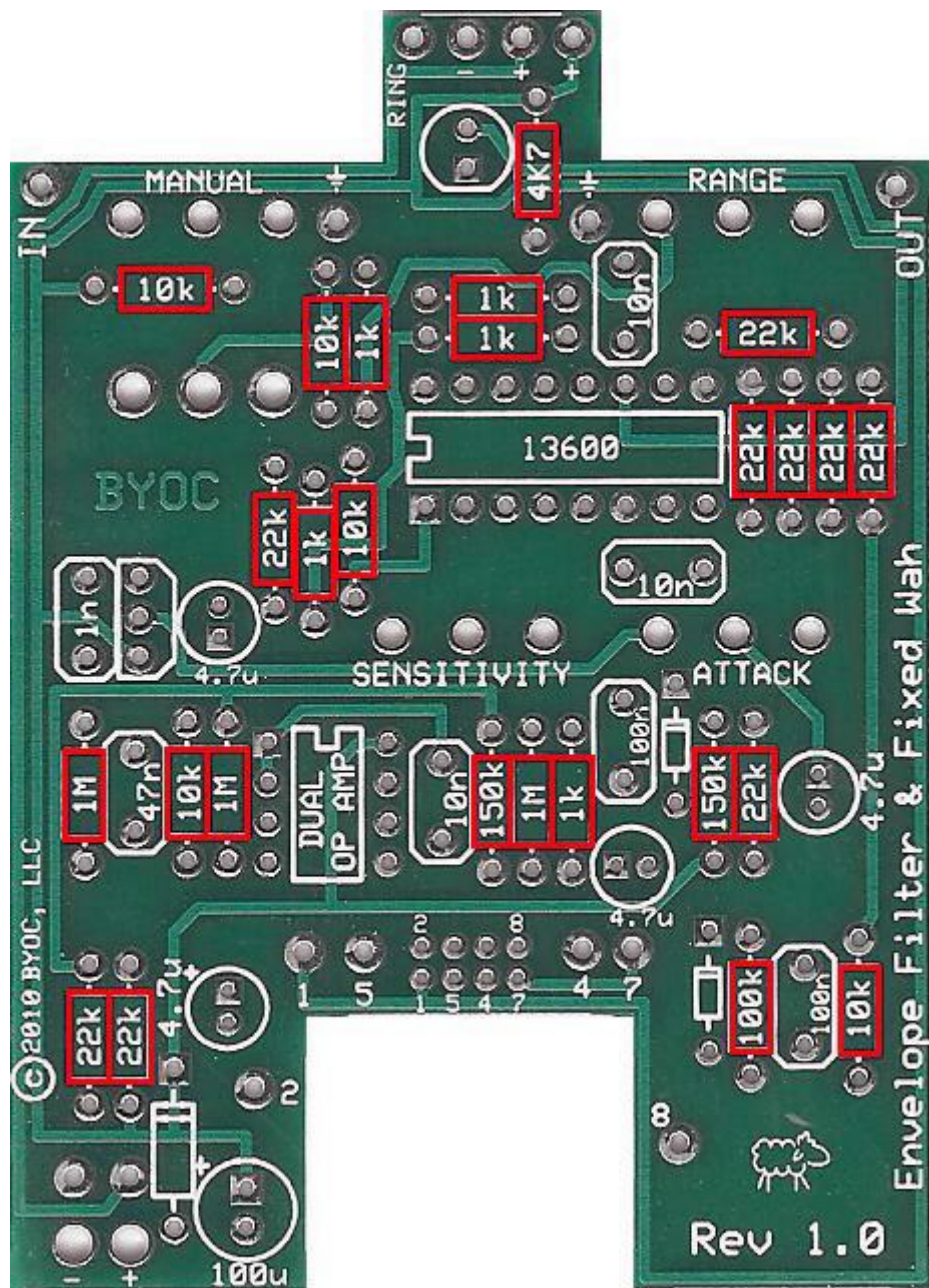

STEP 1: Add the resistors . Resistors are not polarized, so it does not matter which end goes in which solder pad.

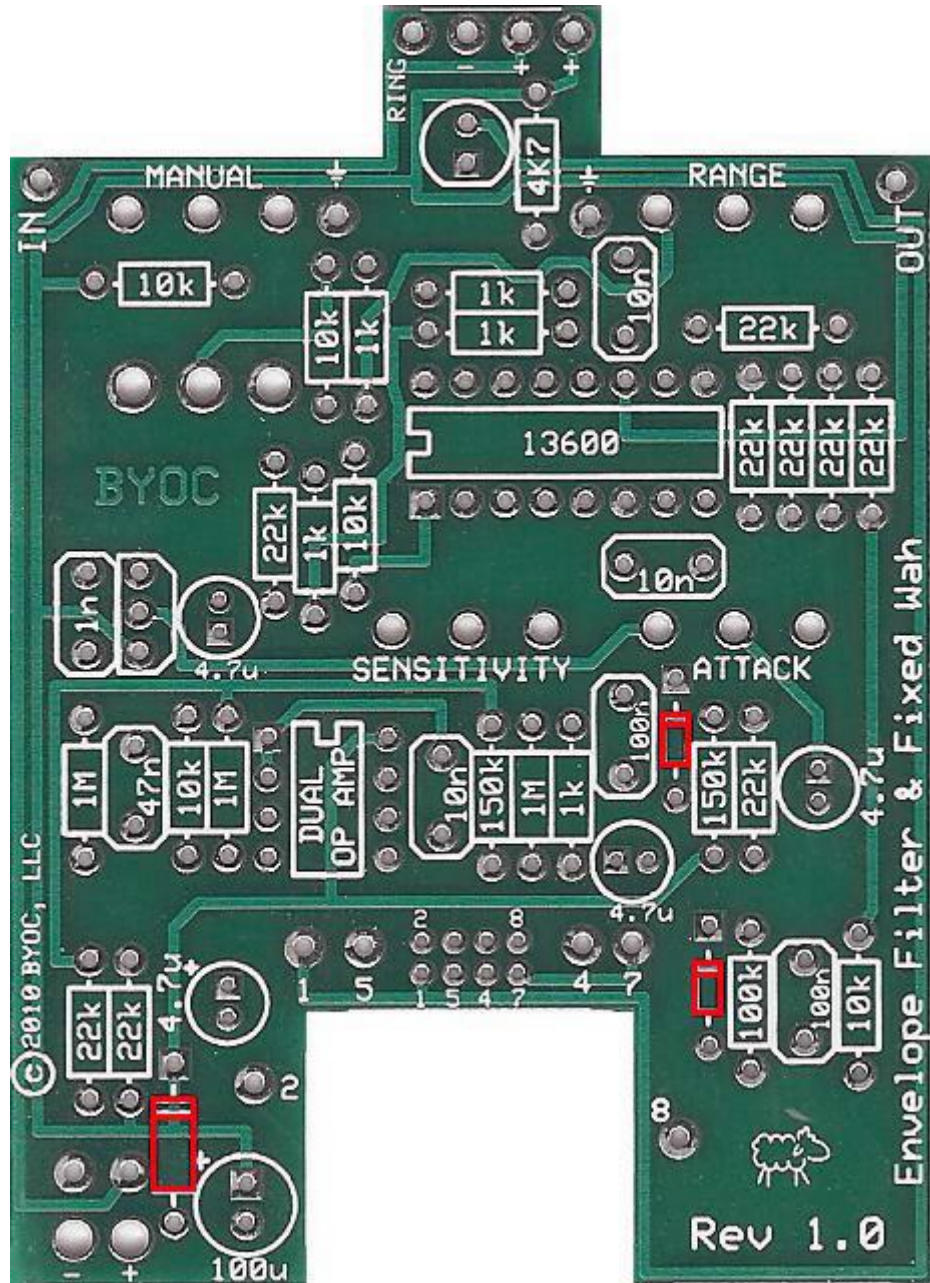

STEP 2: Add the diodes. Be sure to match the end of the diode with the stripe to the layout on the PCB. The stripped end should go in the square solder pad. The black plastic 1N4001 diode goes in the larger diode space. The orange glass 1N4148 diodes go in the smaller diode spaces.

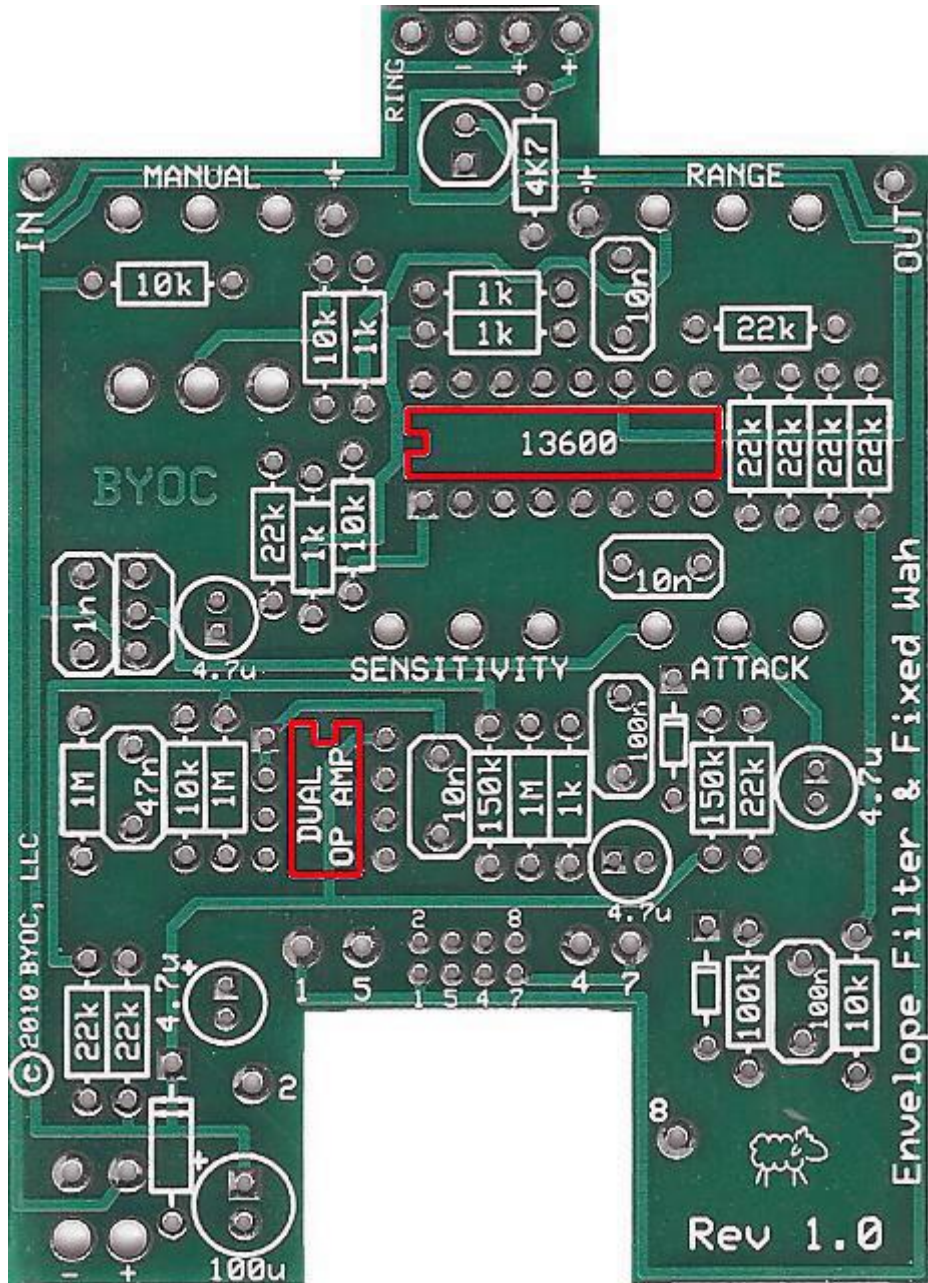

STEP 3: Add the 8 pin and 16 pin IC sockets. **ONLY SOLDER THE SOCKET! NOT THE ACTUAL IC!** These are sockets. The sockets get soldered to the PCB. The ICs get inserted into the sockets. The actual IC chips themselves, never get soldered. You will insert the ICs into the sockets after the entire pedal has been built.

See page 21 for instructions on how to install the IC's.

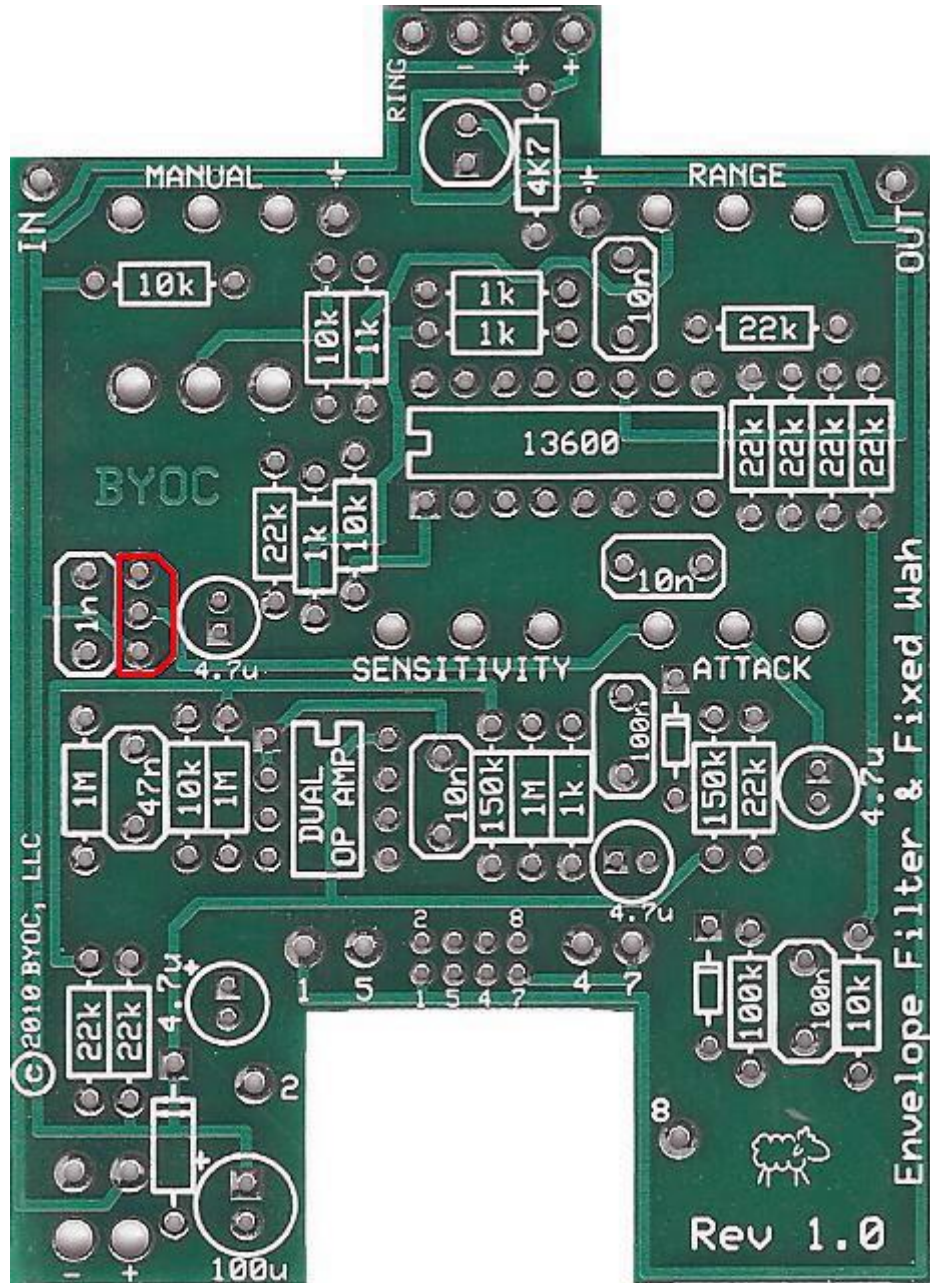

Step 4: Add the Transistor. Be sure to orient the transistor so that the flat side of the transistor body matches up with the flat side on the PCB layout.

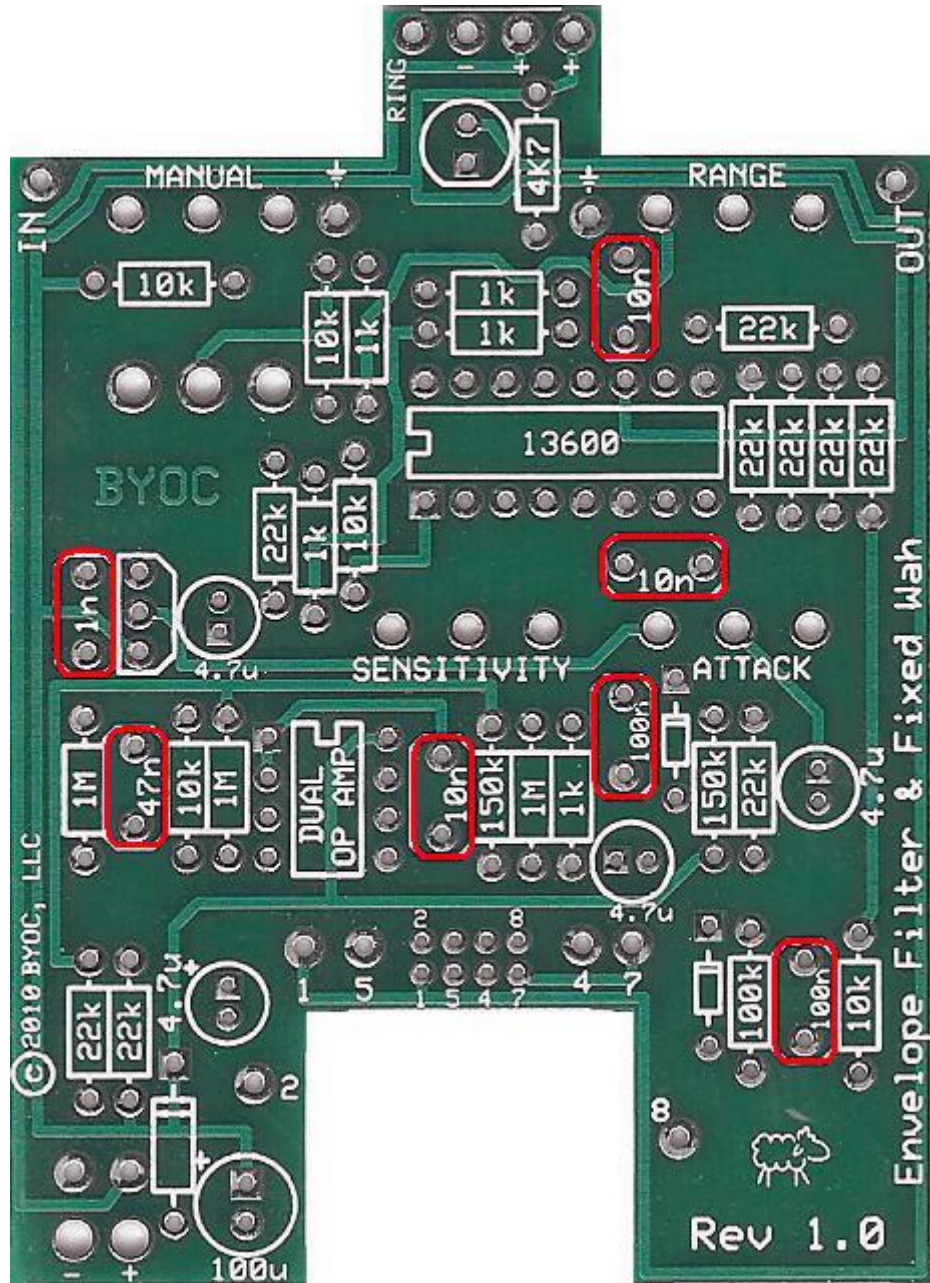

Step 5: Add the film capacitors. These are not polarized and can be inserted into the PCB either way.

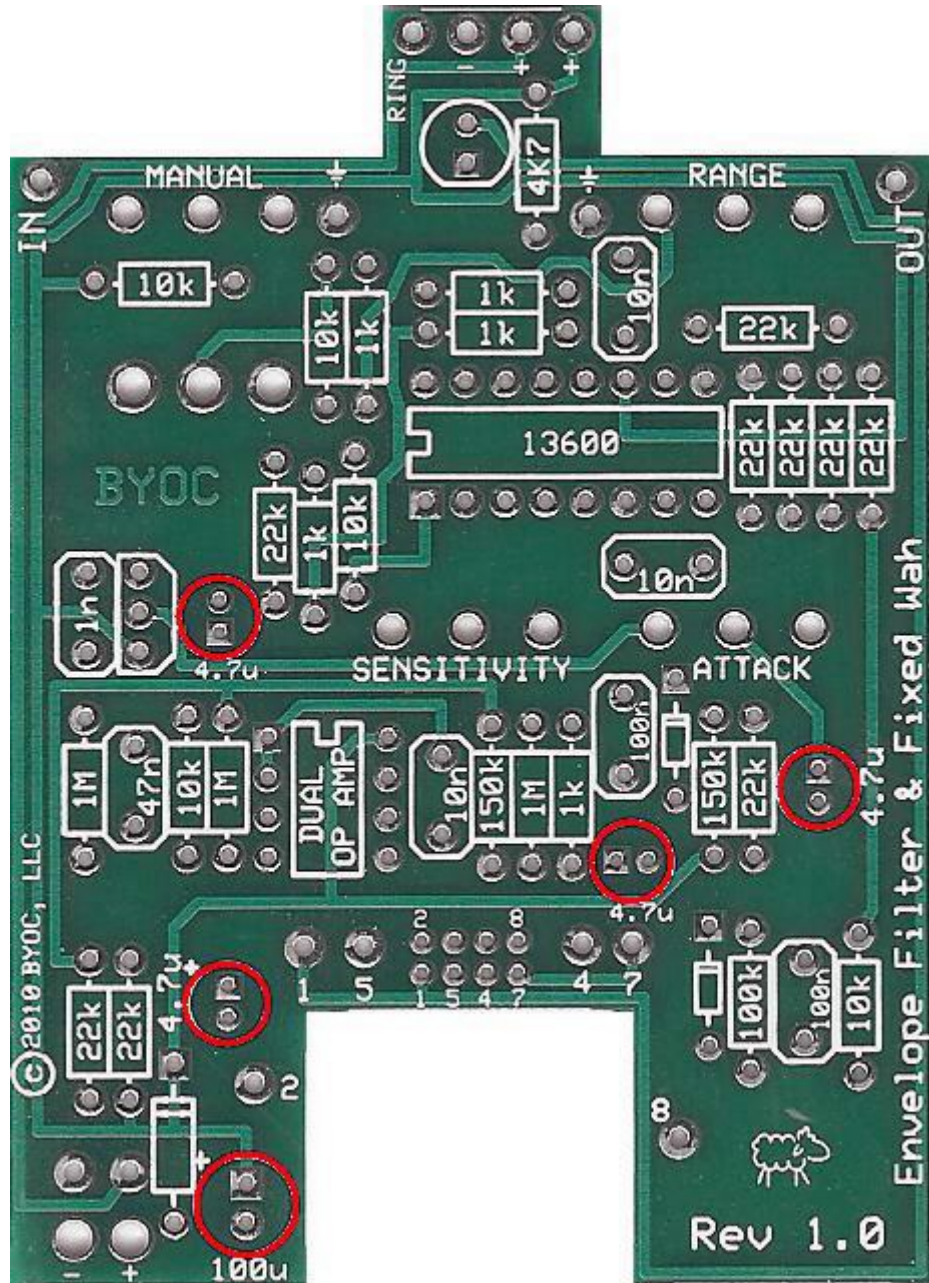

STEP 6: Add the aluminum electrolytic capacitors. These are polarized. The positive end will have a longer lead and should go in the square solder pad. The negative end will have a shorter lead with a black or white stripe running down the body of the capacitor.

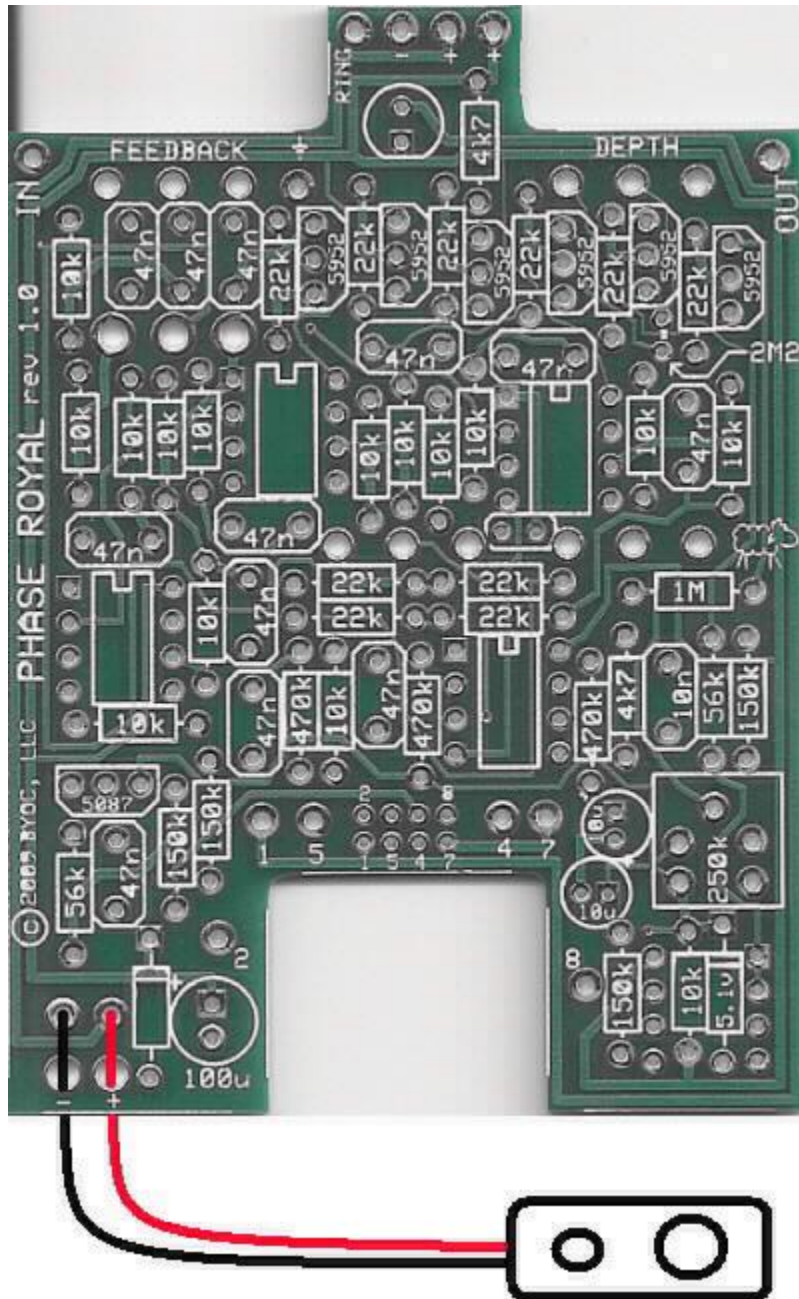

Step 7: Add the battery snap. Thread the solder ends of the battery snap into the strain relief holes from the bottom solderside of the PCB and out through the top. Insert the solder ends of the battery snap wires into the topside of their respective solder pads. Solder on the bottom side of the PCB. Remember the red wire goes in the “+” hole and the black wire goes in the “-” hole.

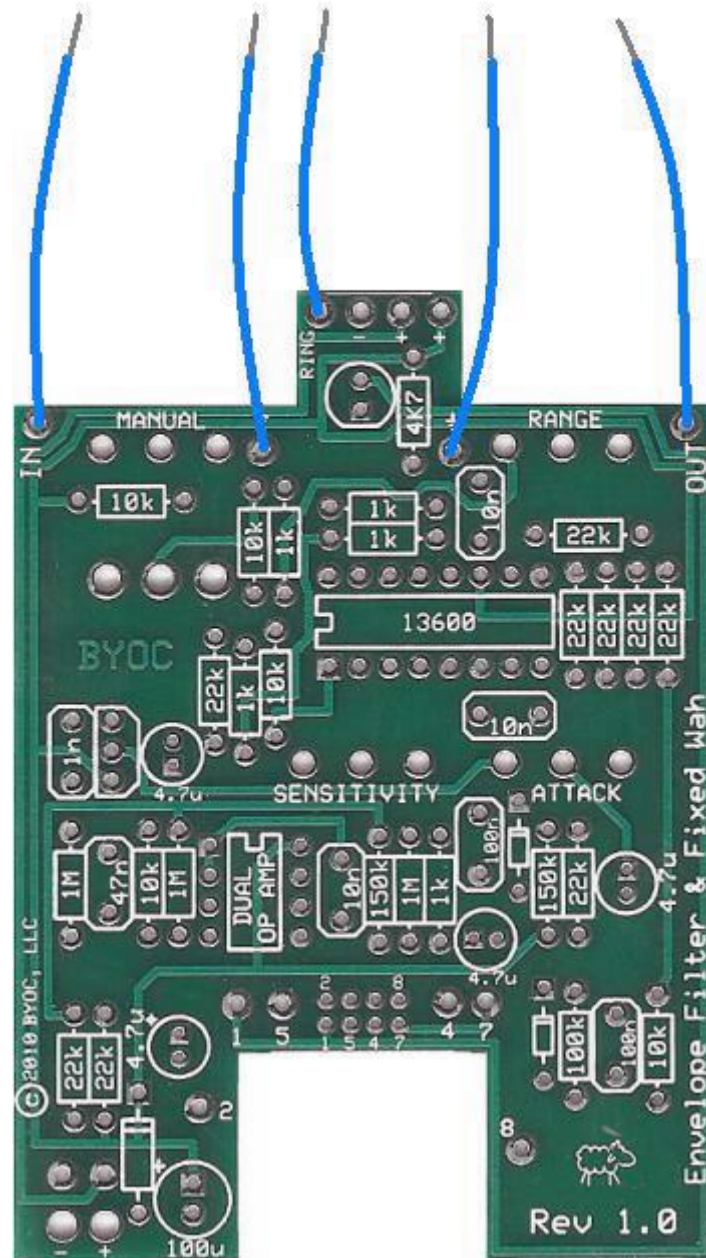

Step 8: Add wires to the IN, OUT, RING, and two Ground eyelets. Start by cutting four 2.5" pieces of wire and one 1.5" piece of wire. Strip 1/4" off each end and tin the ends. Tinning means to apply some solder to the stripped ends of the wires. This keeps the strands from fraying and primes the wire for soldering. Solder a 2.5" piece of wire to each of the IN, OUT, and Ground eyelets on the PCB. Solder the 1.5" piece of wire to the RING eyelet on the PCB. Load the wires in from the top and solder on the bottom of the PCB.

Main PCB Assembly

Step 1: Mount the DC adaptor jack to the enclosure.

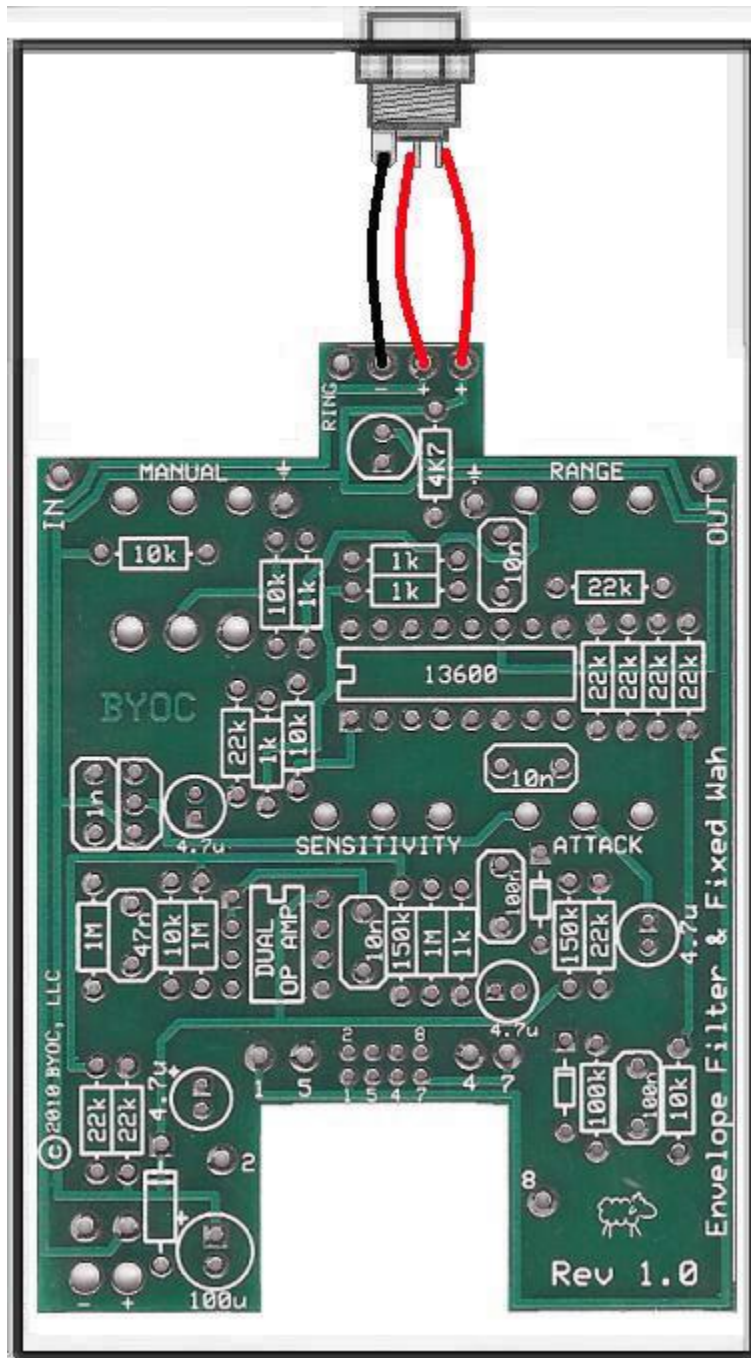

Step 2: Connect the TIP (negative) terminal of the DC adaptor jack to the “-” eyelet on the PCB with 2 inches of hook up wire. Connect the SLEEVE of the DC adaptor jack to the “+” eyelet on the far right side of the PCB with 2 inches of hook up wire. Connect the battery disconnect terminal of the DC adaptor jack to the “+” eyelet more towards the center of the PCB with 2” of hookup wire. Load the wires in from the bottom of the PCB and solder on the topside.

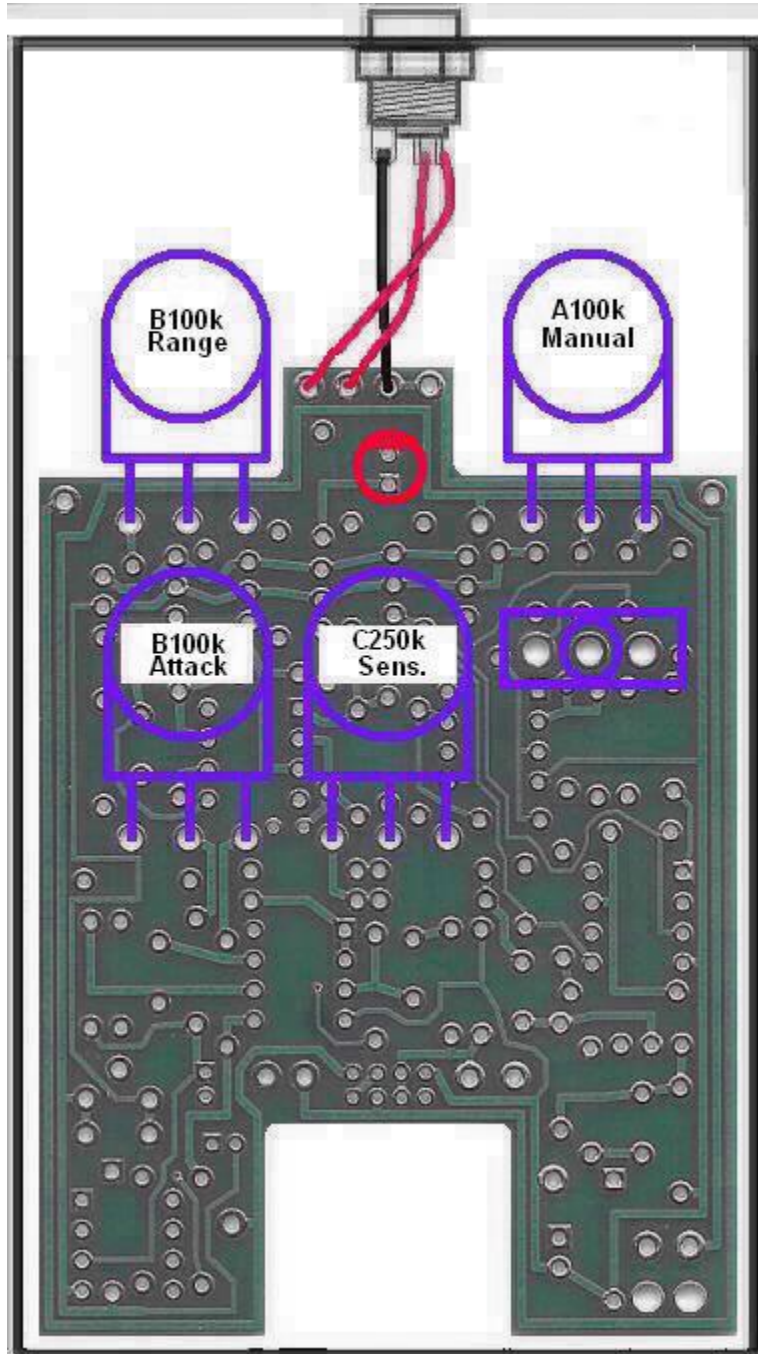

Step 3: Flip the PCB over so that the bottom or solder side is up. Insert the 2 x B100k(range & attack),C250k(sensitivity), A100K(manual) potentiometers, the SPDT toggle switch, and the LED into the bottom side of the PCB. **DO NOT SOLDER ANYTHING YET!!!** The LED will have one lead that is longer than the other. The longer lead goes in the hole with the square solder pad.

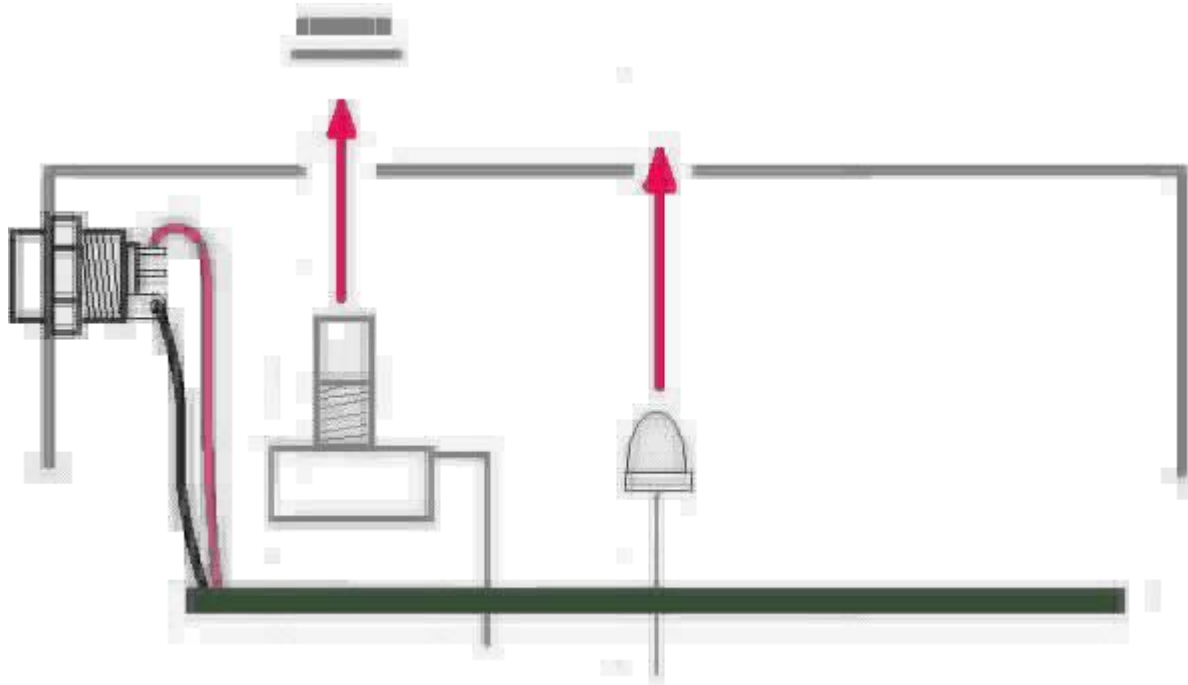

Step 4: Hold the PCB in one hand so that the component side of the PCB is in the palm of your hand and the bottom side with the pots, toggle switch and LED is facing up. Now use your other hand to guide the predrilled enclosure onto the PCB assembly so that the pots and LED all go into their respective holes. Once the PCB assembly is in place, secure it by screwing on the washers and nuts for the pots and toggle switch. Only tighten them with your fingers. You do not want them very tight yet. Be sure to keep your hand on the PCB so that it does not fall off the PCB mounting posts of the pots and toggle switch.

Step 5: Turn the entire pedal over so that the component side of the PCB is facing up. Lift the PCB up off the pots and toggle switch about 2mm just to make sure that the back of the PCB does not short out against the pots. Make sure the PCB is level and symmetrically seated inside the enclosure.

Step 6: Solder the pots and LEDs. You will solder these parts on the component side of the PCB. After you have soldered them in place, be sure to tighten up their nuts.

Wiring

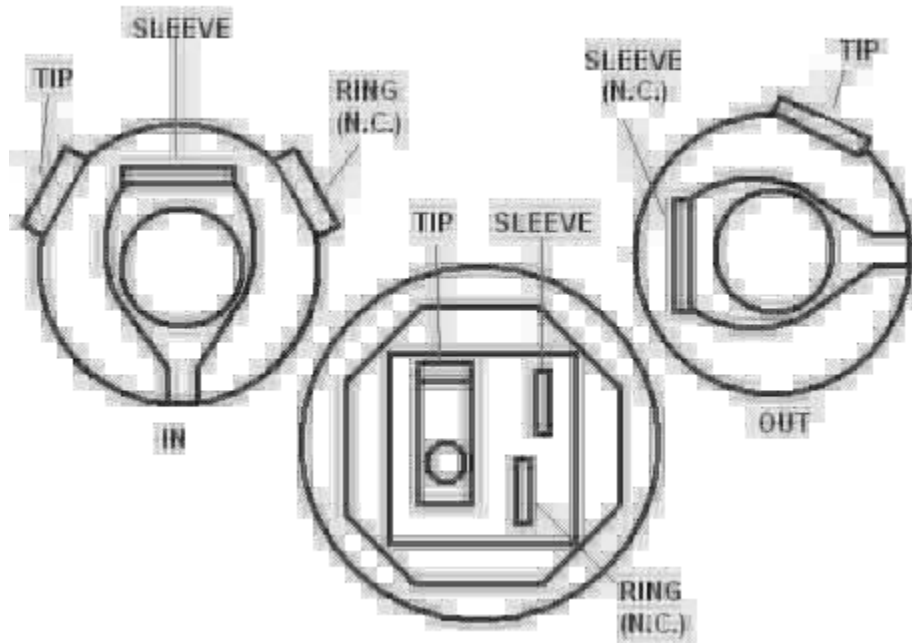

Step 1: Install the 1/4" jacks to the enclosure. Be sure to turn the OUT jack a 1/4 turn counter clockwise so that solder terminal for the tip does not short out against the enclosure.

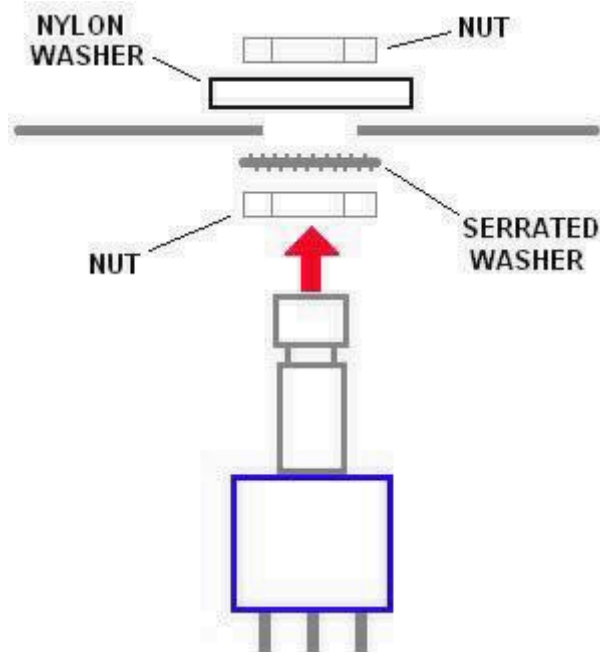

Step 2: Install the footswitch. Orient the footswitch so that the flat sides of the solder lugs are like the diagram below. NOTE: There are no actual number markings on the footswitch. There are two correct ways you can orient the footswitch. They are both 180

degrees of each other. Either way is fine. It does not matter as long as the flat sides of the solder lugs are running horizontal, not vertical.

Footswitch Solder Lug Designations

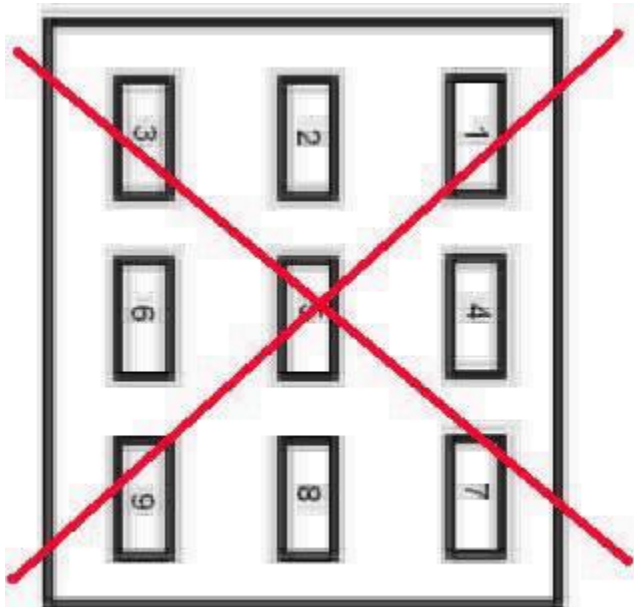
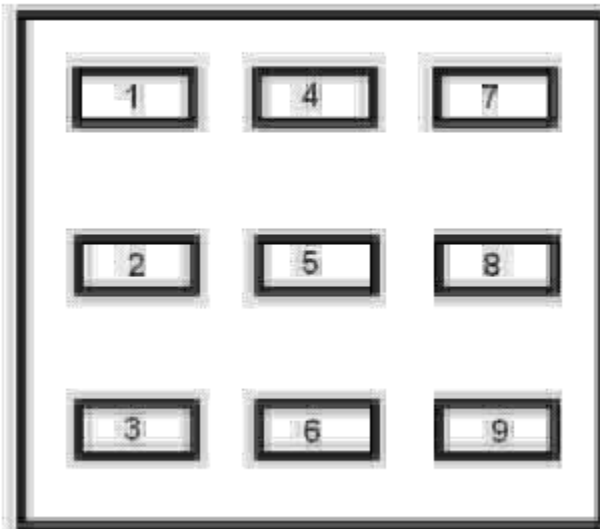

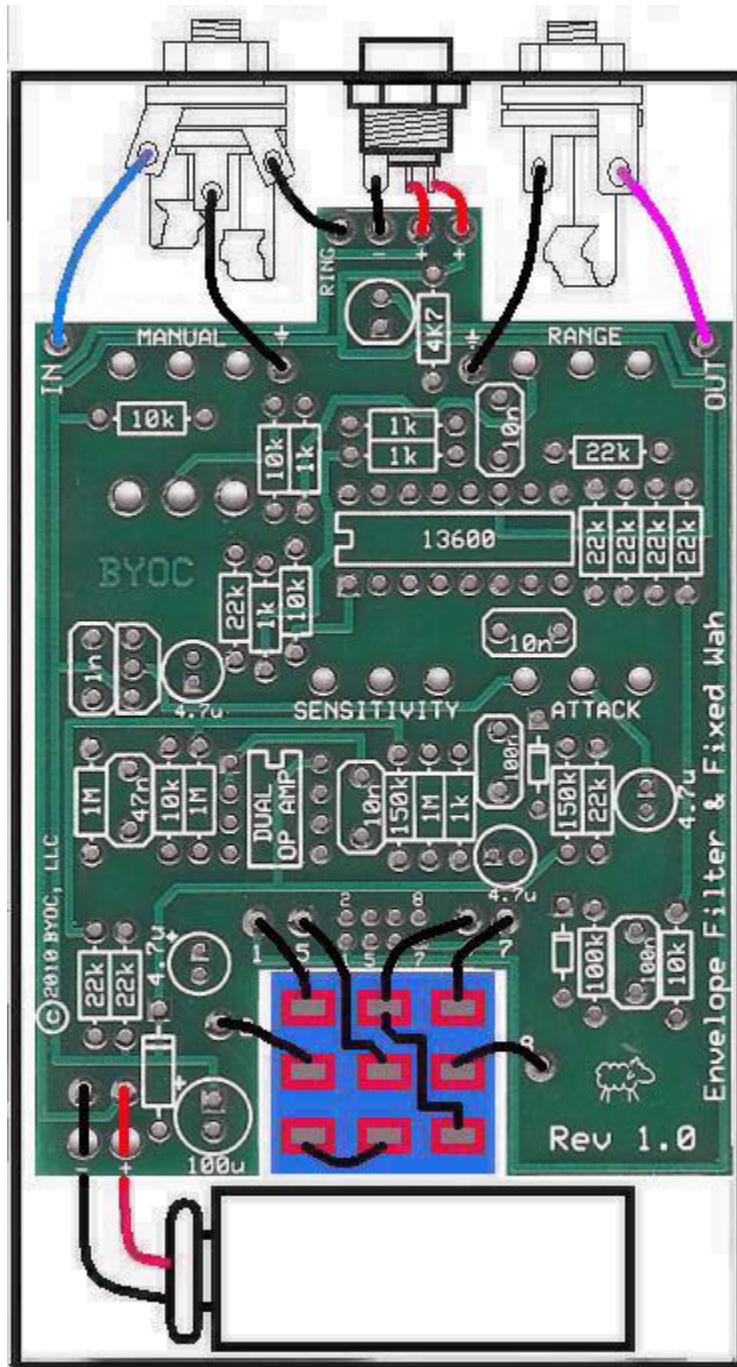

Step 3: Connect the pre stripped and tinned wires to the 1/4" jacks.

Step 4:

- Cut 4 x 3/4" pieces of wire. Strip 1/8" off each end. These will be used to connect lugs/eyelets 1, 2, 7, & 8
- Cut 1 x 1" piece of wire. Strip 1/8" off each end. This will be used to connect lug/eyelet 5
- Cut 1 x 1.5" peice of wire. Strip 1/8" of one end. Strip 1/2" off the other end. This will be used to connect lug/eyelet 4. The longer stripped end will be used to jumper lug 4 to 9.

- Cut 3 x 2" pieces of wire. Strip 1/4" off each end. These will be used to connect the tip and sleeve of the IN jack and the tip of the OUT jack to the PCB.
- Cut 1 x 1.5" piece of wire. Strip 1/4" off each end. This will be used to connect the ring of the IN jack to the ring eyelet on the PCB.

Step 5: Solder one end of the pre-cut and pre-stripped wires to the footswitch.

Step 6: Insert the other remaining ends of the pre-cut and pre-stripped wires into the topside of the PCB and solder. You can solder these on the topside as well. It is easier this way, but you may burn a small amount of the PVC coating on the wires. This is purely aesthetic and won't damage the wires in anyway. But you can avoid this by removing the PCB assembly and footswitch from the enclosure entirely (the PCB assembly will still be attached to the enclosure via the DC jack wiring) so that you have access to solder the underside of the PCB.

Installing the IC's and Finishing Up

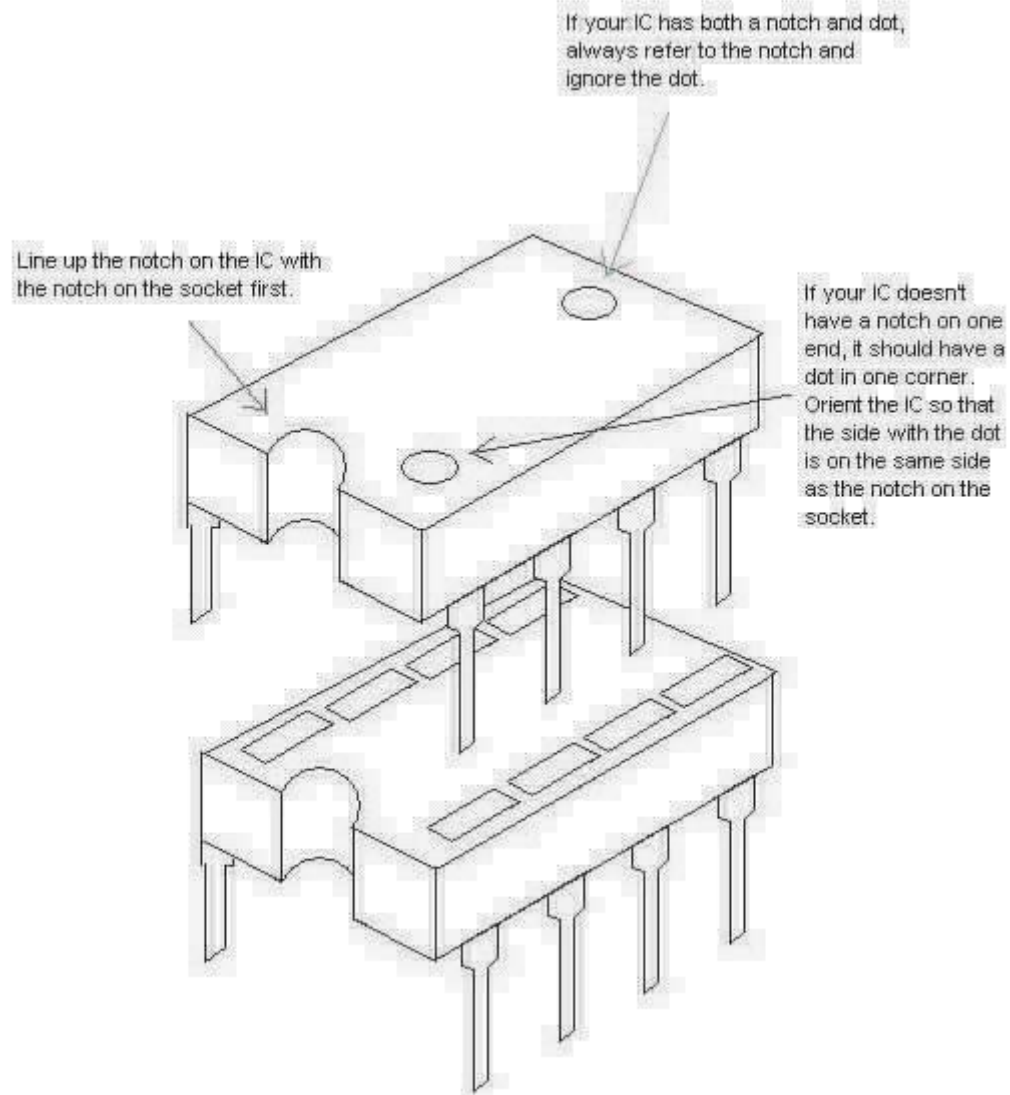

Don't forget to put the cover on the enclosure and apply the bumpers to the cover if you like to use them.

Operating Overview

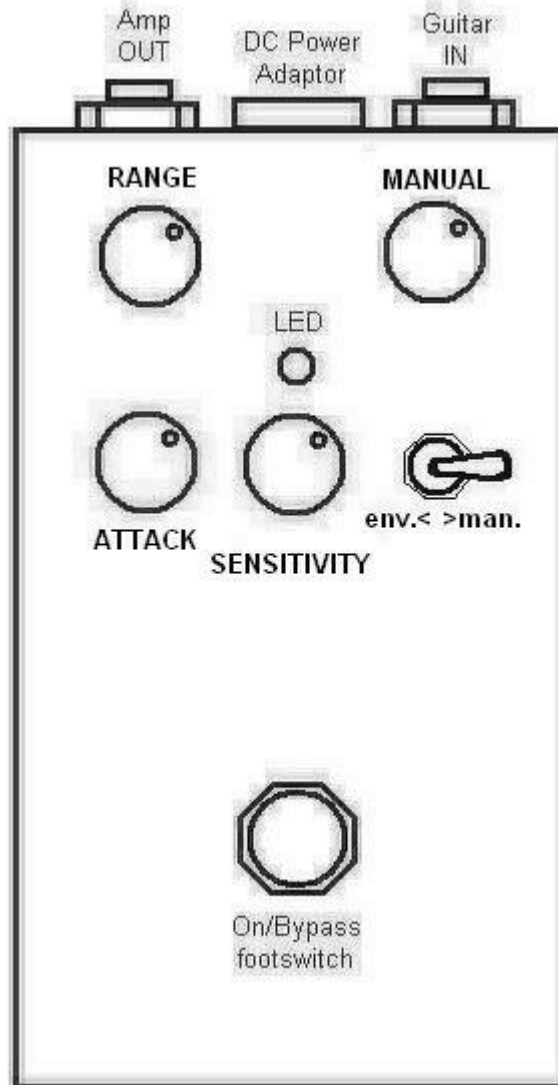

ATTACK: Controls how quickly the envelope trigger changes the filter

RANGE: Controls the intensity of the filter effect

SENSITIVITY: Controls how hard you need to pick in order to trigger the envelope.

MANUAL: Manual controls the filter sweep when the toggle switch is in the “man.” position

Envelope/Manual SWITCH: Sets whether the filter is controlled by the envelope trigger or by the manual knob. The sweep is controlled manually when the toggle is towards the right. This is the fixed wah effect.

DC power supply - Use a 2.5mm negative tip 9VDC adaptor (this is your standard guitar fx style adaptor). If using battery power, only use a single 9V battery.

Current Draw - 5.5mA

Input Impedance - 1M ohms

Output Impedance - 100k ohms

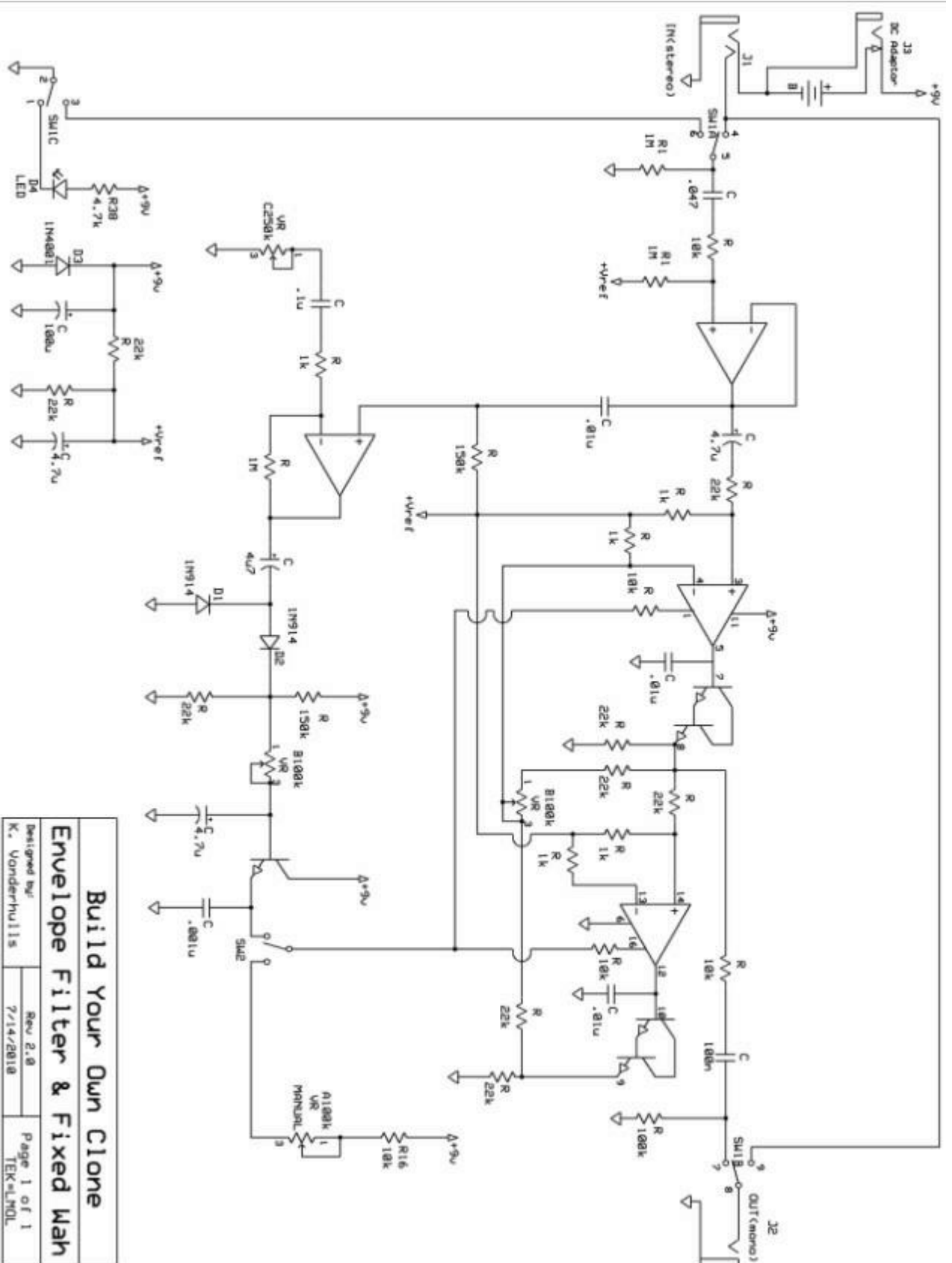

Build Your Own Clone

Envelope Filter & Fixed Wah

Designed by: K. Vonderhulst	Rev 2.8 7/14/2018	Page 1 of 1 TEK=LMOL
--------------------------------	----------------------	-------------------------

Please visit
<http://buildyourownclone.com/board>
for any technical support

copyright 2010
B.Y.O.C., LLC