

RH850 Evaluation Platform

RH850/F1H 100-pin PiggyBack board T2-V1

Y-RH850-F1X-100PIN-PB-T2-V1

All information contained in these materials, including products and product specifications, represents information on the product at the time of publication and is subject to change by Renesas Electronics Corp. without notice. Please review the latest information published by Renesas Electronics Corp. through various means, including the Renesas Technology Corp. website (<http://www.renesas.com>).

The newest version of this document can be obtained from the following web location
<http://www.renesas.eu/updates?oc=Y-RH850-F1X-100PIN-PB-T2-V1>

Table of Contents

Chapter 1	Introduction	3
Chapter 2	Overview	4
2.1	Overview	4
2.1.1	RH850-F1X-100PIN-PB-T2-V1	4
2.2	Mounting of the device	5
Chapter 3	Power supply	6
3.1	Board power connection	6
3.2	Voltage distribution	7
Chapter 4	Clock sources	8
4.1.1	MainOsc	8
Chapter 5	Debug and Programming interface	9
Chapter 6	Connectors for ports of device	10
6.1	Push button for RESET	10
6.2	Signal LEDs	10
6.3	Connectors to MainBoard	10
6.3.1	Connector CN1	10
6.3.2	Connector CN2	12
6.3.3	Connector CN3	13
Chapter 7	Mechanical dimensions	16
Chapter 8	Schematic	17
Chapter 9	Revision History	20

Chapter 1 Introduction

The RH850/F1x Application Board is part of the RH850 Evaluation Platform and serves as a simple and easy to use platform for evaluating the features and performance of Renesas Electronics 32-bit RH850/F1x microcontrollers. The piggyback board (Y-RH850-F1X-100PIN-PB-T2-V1) can be used as a standalone board, or can be mated with a mainboard (e.g. Y-RH850-X1X-MB-T2-Vx) for extended functionality.

Main features:

- Socket for mounting of device
- Standalone operation of the board
- Direct supply of device voltage (typ. 3.3V-5.0V)
- Device programming capability
- Device debugging capability
- Pin headers for direct access to each device pin
- Reset switch
- MainOSC circuitry
- Signal LEDs
- Connectors to MainBoard

This document describes the functionality provided by the piggyback board and guides the user through its operation.

For details regarding the operation of the microcontroller, refer to the RH850/F1x User's Manual.

Chapter 2 Overview

2.1 Overview

2.1.1 RH850-F1X-100PIN-PB-T2-V1

Figures 1 and 2 provide the views of the RH850-F1X-100PIN-PB-T2-V1 Piggyback Board.

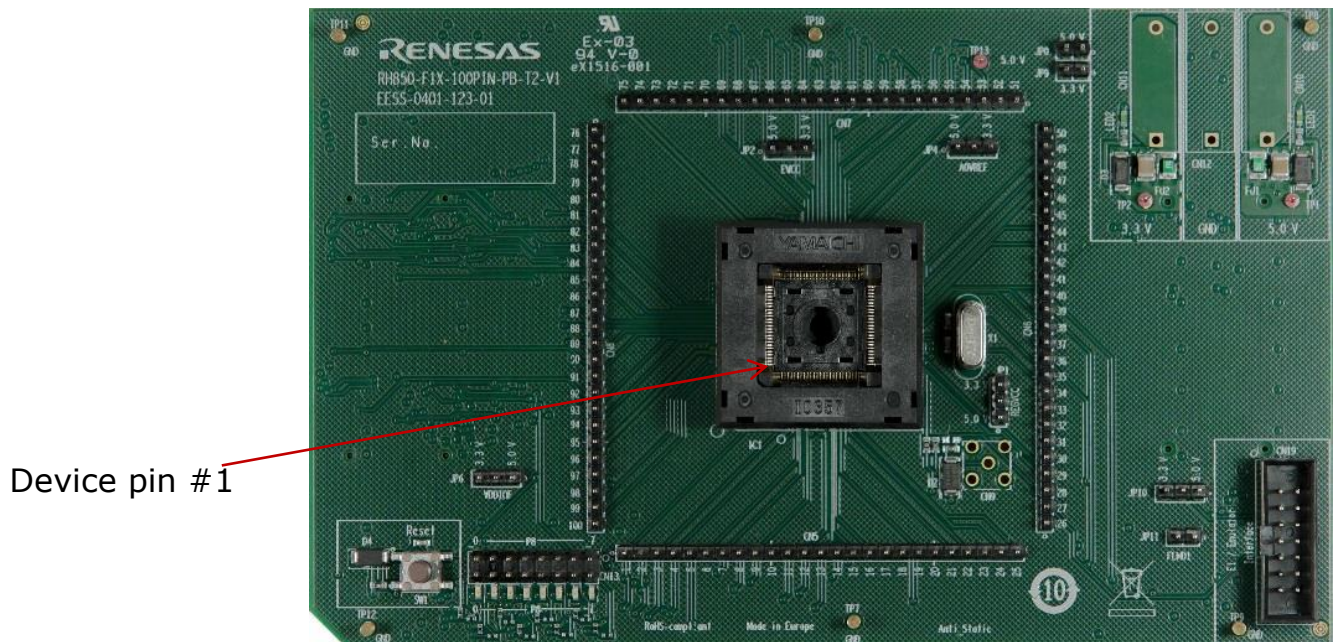

Figure 1 – RH850-F1X-100PIN-PB-T2-V1 top view

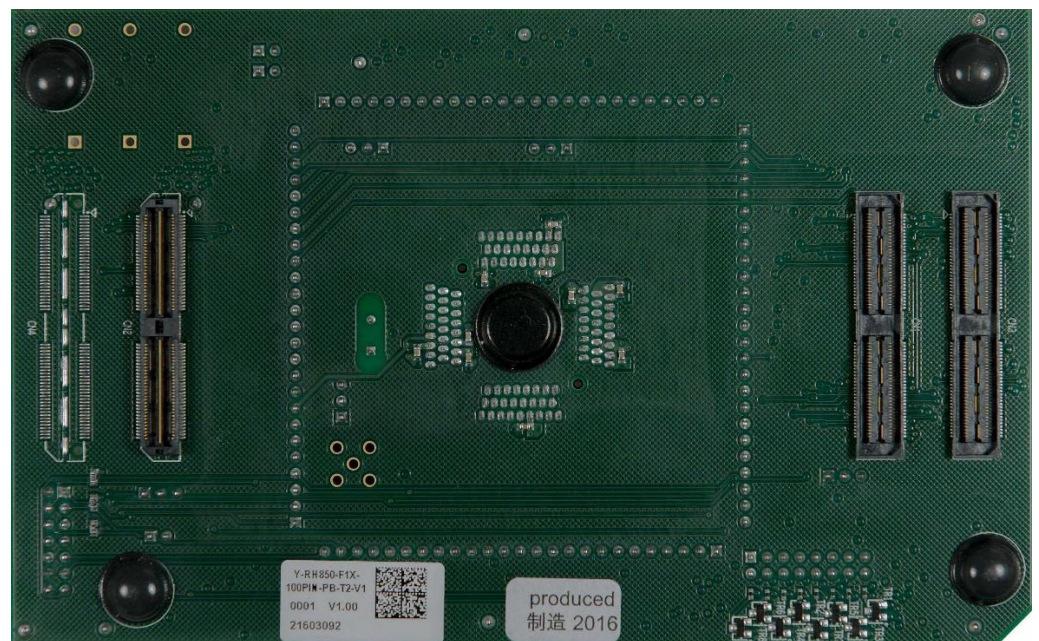

Figure 2 – RH850-F1X-100PIN-PB-T2-V1 bottom view

2.2 Mounting of the device

The board is designed for use with the following device:

RH850/F1H-100 PREMIUM

The device must be placed inside the socket IC1. To insert the device, press down the lid, align the #1 pin of the device to the #1 pin of the socket, insert the device inside the socket and release the lid.

Chapter 3 Power supply

3.1 Board power connection

For operation of the device, a supply voltage must be connected to the board. Though a single supply voltage is sufficient for the operation of the device, two (different) voltages can be supplied to the board.

Within this document the following voltages are considered as 'typical' connections:

Voltage1 = 5.0V

Voltage2 = 3.3V

The following connectors are available to supply those voltages:

Three 4mm 'banana-type' connectors:

- Two red connectors for voltages *Voltage1* (CN10) and *Voltage2* (CN11)
- A black connector for VSS connection on CN12

Note: The three connectors are supplied with the board but are not assembled.

- The E1 emulator that is used for debug purposes and flash programming can also supply a single operating voltage ('Dbg_Voltage'). The voltage is programmable via the E1 GUI as 3.3 or 5.0V (typ). See the documentation of the E1 and chapter 5 'Debug and Programming interface' for details.
- In case the PiggyBoard is mounted on a MainBoard, the voltages *Voltage1* and *Voltage2* are supplied by the on-board regulators of the MainBoard.

NOTE: Do not supply any voltage directly to the PiggyBoard in case it is mounted on the MainBoard.

For each of the two voltages, 'Voltage 1' and 'Voltage 2', a green LED (LED1 and LED2) is available to signal that the related voltage is available on the PiggyBoard.

3.2 Voltage distribution

The table shows the required device power supply pins and their function:

Device supply pin	Function
REGVCC	Supply for the device <u>internal regulators</u> for the digital logic.
EVCC	Supply for <u>ports</u> of AWO area.
A0VREF	Supply for <u>ports</u> and <u>analog functions</u> of ADC0.

Additionally one power supply for MainBoard can be selected:

Supply voltage	Function
VDDIOF	IO supply voltage for components located on a connected mainboard.

- For each of the above voltages, the voltage source can be selected from *Voltage1* (typ. 5.0V) or *Voltage2* (typ. 3.3V) by the jumpers JP0, JP1, JP2, JP3, JP6 and JP9.

See the picture for details:

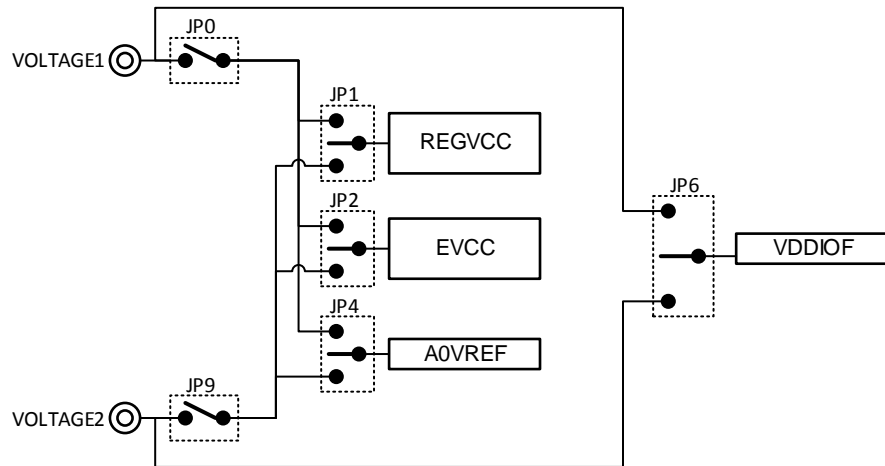

Chapter 4 Clock sources

For mounting of the external crystal oscillator, a socket is available.

4.1.1

MainOsc

A crystal or ceramic resonator in the range of 8MHz to 24MHz can be mounted on socket X1.

A 8MHz and 16Mhz oscillator is supplied with the board.

Chapter 5 Debug and Programming interface

For connection of the microcontroller debug and flash programming tools, the connector CN19 is provided.

The signal connection of the connector CN19 is shown in the picture below:

CN19 pin	Device Port	Device signal
1	JP0_2	DCUTCK / LPDCLK
2	GND	GND
3	JP0_4	DCUTRST
4	FLMD0	FLMD0
5	JP0_1	DCUTDO / LPDO
6	P10_8*	FLMD1
7	JP0_0	DCUTDI / LPDI
8	'Dbg_Voltage'	-
9	JP0_3	DCUTMS
10	-	-
11	JP0_5	DCURDY / LPDCLKOUT
12	GND	-
13	RESET	-
14	GND	-

* In case of connecting a debug/programming tool to CN19, the pin header JP11 must be closed.

The 'Dbg_Voltage' (on CN19 pin 8) can be monitored by the debug and flash programming tools. Therefore it is possible to select either Voltage1 or the Voltage2 by pin header JP10:

JP10 pin	Selection for Dbg_Voltage
1-2	Voltage1 is selected
2-3	Voltage2 is selected

Chapter 6 Connectors for ports of device

Connection to each pin of the device is possible via the connectors CN5 to CN8.

Note :The pin headers are directly connected to the pins, therefore special care must be taken to avoid any electrostatic or other damage to the device.

6.1 Push button for RESET

In order to issue a RESET to the device, the push-button SW1 is available.

6.2 Signal LEDs

Eight LEDs, LED4 to LED11, are provided to allow visual observation of microcontroller output port states.

The LEDs can be connected to P8_0 to P8_7 of the device via the pin header CN13:

CN13 pin	Device Port	LED
1-2	P8_7	LED11 (LEDP8_7)
3-4	P8_6	LED10 (LEDP8_6)
5-6	P8_5	LED9 (LEDP8_5)
7-8	P8_4	LED8 (LEDP8_4)
9-10	P8_3	LED7 (LEDP8_3)
11-12	P8_2	LED6 (LEDP8_2)
13-14	P8_1	LED5 (LEDP8_1)
15-16	P8_0	LED4 (LEDP8_0)

6.3 Connectors to MainBoard

Three connectors (CN1 to CN3) are available to connect the PiggyBoard to a MainBoard.

The signal connection of each connector is described in the following tables:

6.3.1 Connector CN1

Pin	Function	Device Port	Pin	Function	Device Port
1	VOLTAGE1	-	2	VOLTAGE1	-
3	VOLTAGE1	-	4	VOLTAGE1	-
5	RESET	_RESET	6	NMI	P9_0
7	WAKE	-	8	-	-
9	INT0	P9_1	10	INT1	P0_6
11	INT2	P9_2	12	INT3	P9_3
13	-	-	14	-	-

15	UART0TX	P10_10
17	UART0RX	P10_9
19	LIN0TX	P10_10
21	LIN0RX	P10_9
23	IIC0SDL	P10_3
25	IIC0SDA	P10_2
27	CAN0TX	P10_1
29	CAN0RX	P10_0
31	SENTIN0	-
33	SENTOUT0	-
35	PSI50Rx	-
37	PSI50Tx	-
39	PSI50Ssync	-
41	FLX0TX	-
43	FLX0RX	-
45	FLX1TX	-
47	FLX1RX	-
49	-	-
51	ETH0MDIO	-
53	ETH0RXD0	-
55	ETH0RXD1	-
57	ETH0RXD2	-
59	ETH0RXD3	-
61	ETH0RXDCLK	-
63	ETH0RXER	-
65	ETH0CRSDV	-
67	ETH0RXDV	-
69	ETH0RESET	-
71	-	-
73	USB0UDMF	-
75	USB0UDPF	-
77	-	-
79	-	-
81	-	-
83	-	-
85	DIGIO_0	P8_0
87	DIGIO_2	P8_2
89	DIGIO_4	P8_4
91	DIGIO_6	P8_6
93	DIGIO_8	P10_0
95	DIGIO_10	P10_8
97	DIGIO_12	P0_9
99	DIGIO_14	P0_11
101	-	-
103	MUX0	P10_4

16	UART1TX	P0_5
18	UART1RX	P0_4
20	LIN1TX	P0_8
22	LIN1RX	P0_7
24	IIC1SDL	-
26	IIC1SDA	-
28	CAN1TX	P0_3
30	CAN1RX	P0_2
32	SENTIN1	-
34	SENTOUT1	-
36	PSI51Rx	-
38	PSI51Tx	-
40	PSI51Sync	-
42	FLX0EN	-
44	FLXSTPWT	-
46	FX1EN	-
48	FLXCLK	-
50	-	-
52	ETH0MDC	-
54	EH0TXD0	-
56	EH0TXD1	-
58	EH0TXD2	-
60	EH0TXD3	-
62	ETH0TXCLK	-
64	ETH0TXER	-
66	ETH0TXEN	-
68	ETH0COL	-
70	-	-
72	-	-
74	USB0UDMH	-
76	USB0UDPH	-
78	-	-
80	-	-
82	-	-
84	-	-
86	DIGIO_1	P8_1
88	DIGIO_3	P8_3
90	DIGIO_5	P8_5
92	DIGIO_7	P11_0
94	DIGIO_9	P10_7
96	DIGIO_11	P10_15
98	DIGIO_13	P0_10
100	DIGIO_15	P0_12
102	-	-
104	MUX1	P10_5

105	MUX2	P10_6
107	ADC0	AP0_8
109	ADC2	AP0_2
111	ADC4	AP0_4
113	ADC6	AP0_6
115	VDDIOF	-
117	VOLTAGE2	-
119	VOLTAGE2	-

106	-	-
108	ADC1	AP0_1
110	ADC3	AP0_3
112	ADC5	AP0_5
114	ADC7	AP0_7
116	VDDIOF	-
118	VOLTAGE2	-
120	VOLTAGE2	-

6.3.2 Connector CN2

Pin	Function	Device Port
1	CAN2Tx	P0_4
3	CAN2Rx	P0_5
5	CAN4Tx	P0_10
7	CAN4Rx	P0_9
9	LIN2Tx	P0_10
11	LIN2Rx	P0_9
13	LIN4Tx	P11_2
15	LIN4Rx	P11_1
17	LIN6Tx	-
Q	LIN6Rx	-
21	LIN8Tx	-
23	LIN8Rx	-
25	LIN10Tx	-
27	LIN10Rx	-
29	LIN12Tx	-
31	LIN12Rx	-
33	LIN14Tx	-
35	LIN14Rx	-
37	-	-
39	-	-
41	MLBCLK	-
43	MLBSIG	-
45	-	-
47	CAN6Tx	P10_5
49	CAN6Rx	P10_4
51	-	-
53	-	-
55	-	-
57	-	-
59	-	-

Pin	Function	Device Port
2	CAN3Tx	P11_4
4	CAN3Rx	P11_3
6	CAN5Tx	P11_6
8	CAN5Rx	P11_5
10	LIN3Tx	P20_5
12	LIN3Rx	P20_4
14	LIN5Tx	-
16	LIN5Rx	-
18	LIN7Tx	-
20	LIN7Rx	-
22	LIN9Tx	-
24	LIN9Rx	-
26	LIN11Tx	-
28	LIN11Rx	-
30	LIN13Tx	-
32	LIN13Rx	-
34	LIN15Tx	P10_11
36	LIN15Rx	P10_12
38	-	-
40	-	-
42	MLBRESET	-
44	MLBDAT	-
46	-	-
48	CAN7Tx	P10_13
50	CAN7Rx	P10_14
52	-	-
54	-	-
56	-	-
58	-	-
60	-	-

61	-	-
63	-	-
65	-	-
67	-	-
69	-	-
71	-	-
73	-	-
75	-	-
77	-	-
79	-	-
81	-	-
83	-	-
85	-	-
87	-	-
89	-	-
91	-	-
93	-	-
95	-	-
97	-	-
99	-	-
101	-	-
103	-	-
105	-	-
107	-	-
109	-	-
111	-	-
113	-	-
115	-	-
117	-	-
119	-	-

62	-	-
64	-	-
66	-	-
68	-	-
70	-	-
72	-	-
74	-	-
76	-	-
78	-	-
80	-	-
82	-	-
84	-	-
86	-	-
88	-	-
90	-	-
92	-	-
94	-	-
96	-	-
98	-	-
100	-	-
102	-	-
104	-	-
106	-	-
108	-	-
110	-	-
112	-	-
114	-	-
116	-	-
118	-	-
120	-	-

6.3.3 Connector CN3

Pin	Function	Device Port
1	PWM00	P10_0
3	PWM02	P10_2
5	PWM04	P10_7
7	PWM06	P10_9
9	PWM08	P9_0
11	PWM10	P0_4
13	PWM12	P0_2
15	PWM14	P8_0

Pin	Function	Device Port
2	PWM01	P10_1
4	PWM03	P10_3
6	PWM05	P10_8
8	PWM07	P10_10
10	PWM09	P9_1
12	PWM11	P0_1
14	PWM13	P0_3
16	PWM15	-

17	PWM16	-
19	PWM18	-
21	PWM20	P9_0
23	PWM22	-
25	PWM24	-
27	PWM26	-
29	PWM28	P11_3
31	PWM30	-
33	PWM32	-
35	PWM34	-
37	PWM36	-
39	PWM38	P8_6
41	PWM40	-
43	PWM42	-
45	PWM44	-
47	PWM46	-
49	PWM48	-
51	PWM50	-
53	PWM52	-
55	PWM54	-
57	PWM56	-
59	PWM58	-
61	PWM60	-
63	PWM62	-
65	PWM64	-
67	PWM66	-
69	PWM68	-
71	PWM70	-
73	PWM72	-
75	PWM74	-
77	PWM76	-
79	PWM78	-
81	PWMADC00	AP0_8
83	PWMADC02	AP0_10
85	PWMADC04	AP0_12
87	PWMADC06	AP0_14
89	PWMADC08	-
91	PWMADC10	-
93	PWMADC12	-
95	PWMADC14	-
97	-	-
99	-	-
101	-	-
103	-	-
105	-	-

18	PWM17	-
20	PWM19	-
22	PWM21	-
24	PWM23	-
26	PWM25	P11_0
28	PWM27	P11_2
30	PWM29	P11_4
32	PWM31	-
34	PWM33	-
36	PWM35	-
38	PWM37	-
40	PWM39	-
42	PWM41	-
44	PWM43	-
46	PWM45	-
48	PWM47	-
50	PWM49	-
52	PWM51	-
54	PWM53	-
56	PWM55	-
58	PWM57	-
60	PWM59	-
62	PWM61	-
64	PWM63	-
66	PWM65	-
68	PWM67	-
70	PWM69	-
72	PWM71	-
74	PWM73	-
76	PWM75	-
78	PWM77	-
80	PWM79	-
82	PWMADC01	AP0_9
84	PWMADC03	AP0_11
86	PWMADC05	AP0_13
88	PWMADC07	AP0_15
90	PWMADC09	-
92	PWMADC11	-
94	PWMADC13	-
96	PWMADC15	-
98	-	-
100	-	-
102	-	-
104	-	-
106	-	-

107	-	-
109	-	-
111	-	-
113	-	-
115	-	-
117	-	-
119	-	-

108	-	-
110	-	-
112	-	-
114	-	-
116	-	-
118	-	-
120	-	-

Chapter 7 Mechanical dimensions

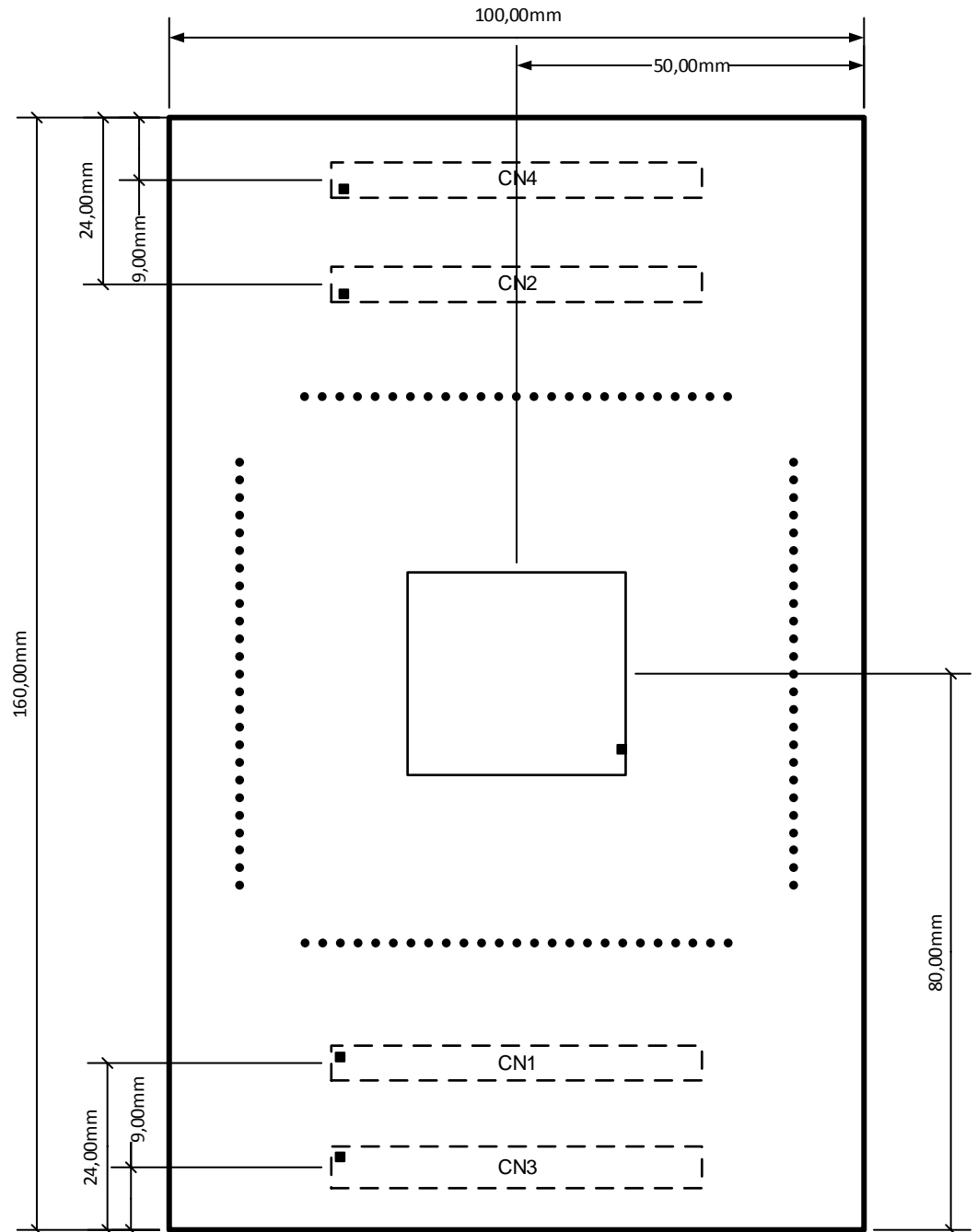

Chapter 8 Schematic

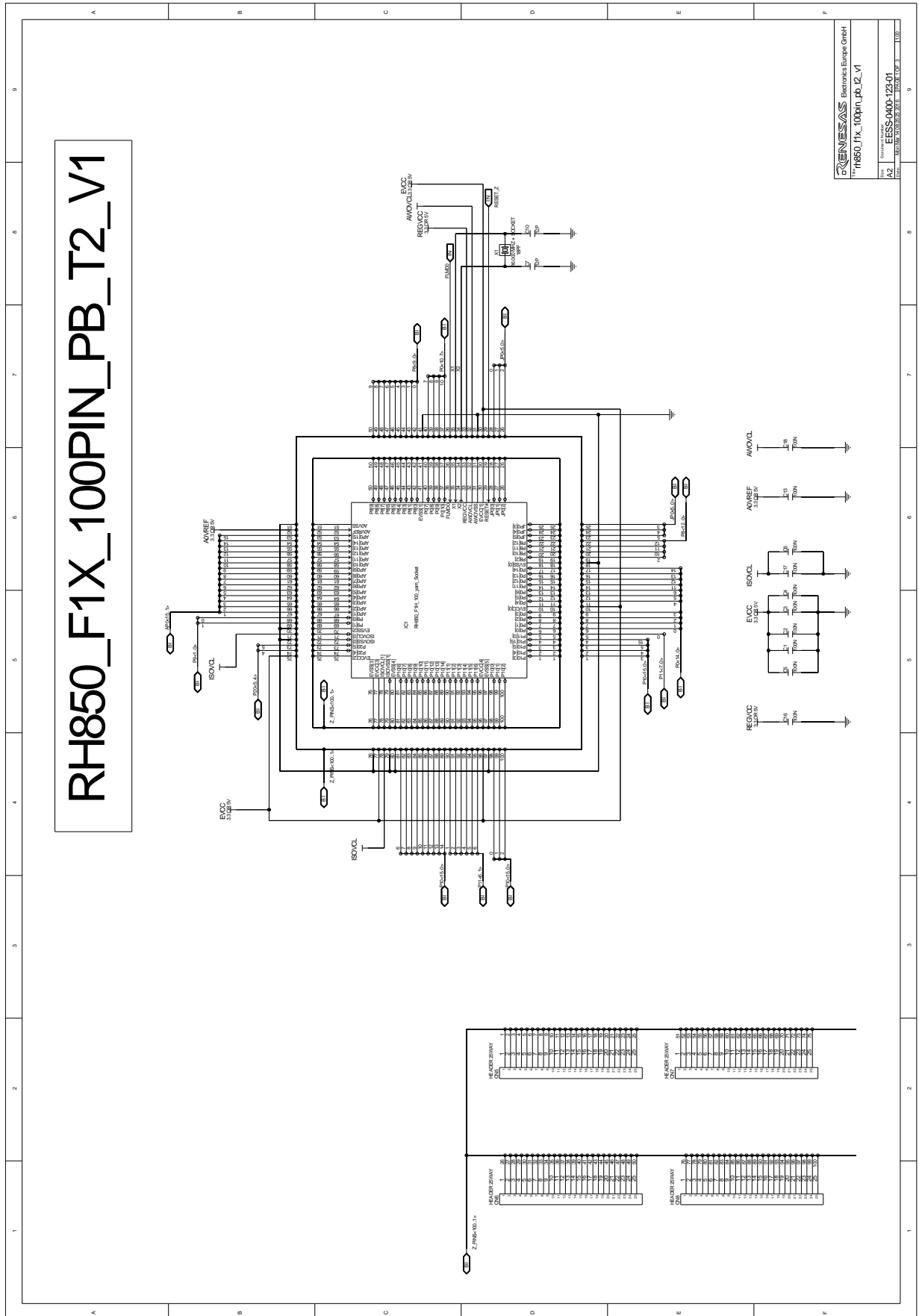

RENEASAS Electronics Europe GmbH
 Y-RH850_F1X_100pin_pb_t2_v1
 Rev. 02
 Date: 2016-05-25
 Part No.: R20UT3802ED0100

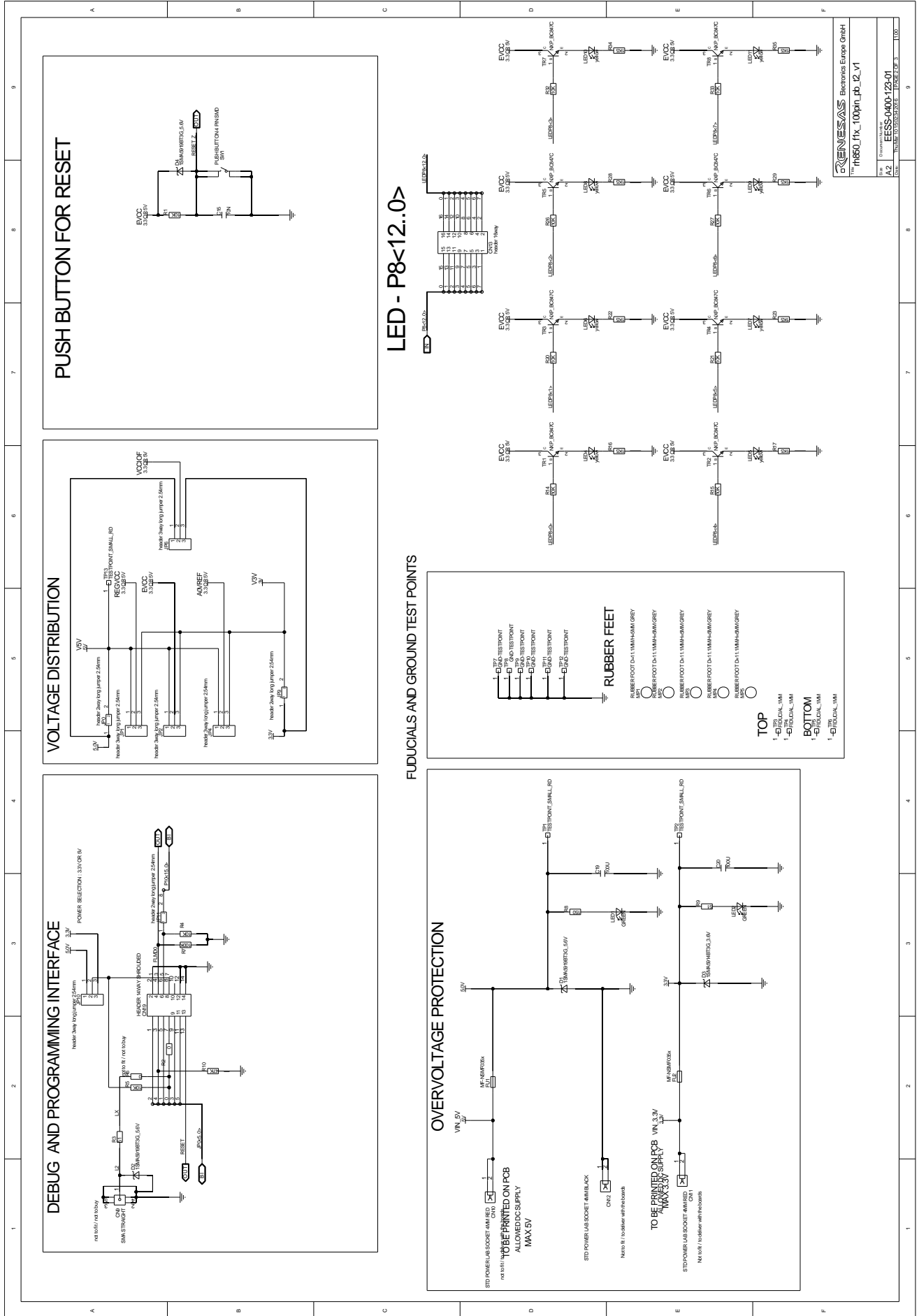

RENESESAS
rh850_f1x_100pin_pb_t2_v1

Electronic Europe GmbH

Document ID: EESS-0400-123-01

Rev: 1.00

DATE: 2016-05-25

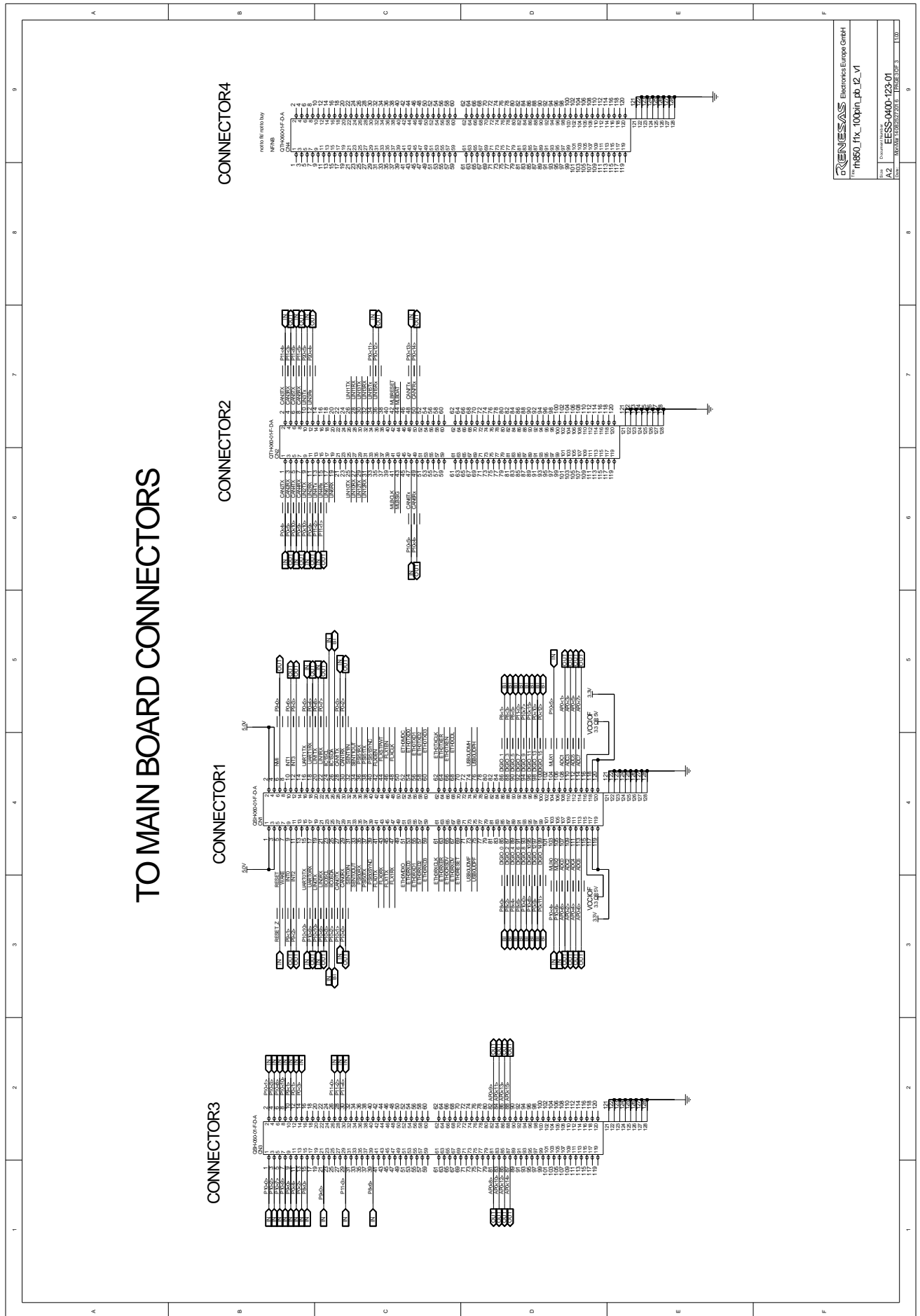

Chapter 9 Revision History

The table provides information about the major changes of the document versions.

Date	Version	Description
2016-05-28	1.0	Initial release

Notice

1. All information included in this document is current as of the date this document is issued. Such information, however, is subject to change without any prior notice. Before purchasing or using any Renesas Electronics products listed herein, please confirm the latest product information with a Renesas Electronics sales office. Also, please pay regular and careful attention to additional and different information to be disclosed by Renesas Electronics such as that disclosed through our website.
2. Renesas Electronics does not assume any liability for infringement of patents, copyrights, or other intellectual property rights of third parties by or arising from the use of Renesas Electronics products or technical information described in this document. No license, express, implied or otherwise, is granted hereby under any patents, copyrights or other intellectual property rights of Renesas Electronics or others.
3. You should not alter, modify, copy, or otherwise misappropriate any Renesas Electronics product, whether in whole or in part.
4. Descriptions of circuits, software and other related information in this document are provided only to illustrate the operation of semiconductor products and application examples. You are fully responsible for the incorporation of these circuits, software, and information in the design of your equipment. Renesas Electronics assumes no responsibility for any losses incurred by you or third parties arising from the use of these circuits, software, or information.
5. When exporting the products or technology described in this document, you should comply with the applicable export control laws and regulations and follow the procedures required by such laws and regulations. You should not use Renesas Electronics products or the technology described in this document for any purpose relating to military applications or use by the military, including but not limited to the development of weapons of mass destruction. Renesas Electronics products and technology may not be used for or incorporated into any products or systems whose manufacture, use, or sale is prohibited under any applicable domestic or foreign laws or regulations.
6. Renesas Electronics has used reasonable care in preparing the information included in this document, but Renesas Electronics does not warrant that such information is error free. Renesas Electronics assumes no liability whatsoever for any damages incurred by you resulting from errors in or omissions from the information included herein.
7. Renesas Electronics products are classified according to the following three quality grades: "Standard", "High Quality", and "Specific". The recommended applications for each Renesas Electronics product depends on the product's quality grade, as indicated below. You must check the quality grade of each Renesas Electronics product before using it in a particular application. You may not use any Renesas Electronics product for any application categorized as "Specific" without the prior written consent of Renesas Electronics. Further, you may not use any Renesas Electronics product for any application for which it is not intended without the prior written consent of Renesas Electronics. Renesas Electronics shall not be in any way liable for any damages or losses incurred by you or third parties arising from the use of any Renesas Electronics product for an application categorized as "Specific" or for which the product is not intended where you have failed to obtain the prior written consent of Renesas Electronics.

The quality grade of each Renesas Electronics product is "Standard" unless otherwise expressly specified in a Renesas Electronics data sheets or data books, etc.

"Standard": Computers; office equipment; communications equipment; test and measurement equipment; audio and visual equipment; home electronic appliances; machine tools; personal electronic equipment; and industrial robots.

"High Quality": Transportation equipment (automobiles, trains, ships, etc.); traffic control systems; anti-disaster systems; anti-crime systems; safety equipment; and medical equipment not specifically designed for life support.

"Specific": Aircraft; aerospace equipment; submersible repeaters; nuclear reactor control systems; medical equipment or systems for life support (e.g. artificial life support devices or systems), surgical implantations, or healthcare intervention (e.g. excision, etc.), and any other applications or purposes that pose a direct threat to human life.

8. You should use the Renesas Electronics products described in this document within the range specified by Renesas Electronics, especially with respect to the maximum rating, operating supply voltage range, movement power voltage range, heat radiation characteristics, installation and other product characteristics. Renesas Electronics shall have no liability for malfunctions or damages arising out of the use of Renesas Electronics products beyond such specified ranges.

9. Although Renesas Electronics endeavors to improve the quality and reliability of its products, semiconductor products have specific characteristics such as the occurrence of failure at a certain rate and malfunctions under certain use conditions. Further, Renesas Electronics products are not subject to radiation resistance design. Please be sure to implement safety measures to guard them against the possibility of physical injury, and injury or damage caused by fire in the event of the failure of a Renesas Electronics product, such as safety design for hardware and software including but not limited to redundancy, fire control and malfunction prevention, appropriate treatment for aging degradation or any other appropriate measures. Because the evaluation of microcomputer software alone is very difficult, please evaluate the safety of the final products or system manufactured by you.
10. Please contact a Renesas Electronics sales office for details as to environmental matters such as the environmental compatibility of each Renesas Electronics product. Please use Renesas Electronics products in compliance with all applicable laws and regulations that regulate the inclusion or use of controlled substances, including without limitation, the EU RoHS Directive. Renesas Electronics assumes no liability for damages or losses occurring as a result of your noncompliance with applicable laws and regulations.
11. This document may not be reproduced or duplicated, in any form, in whole or in part, without prior written consent of Renesas Electronics.
12. Please contact a Renesas Electronics sales office if you have any questions regarding the information contained in this document or Renesas Electronics products, or if you have any other inquiries.

(Note 1) "Renesas Electronics" as used in this document means Renesas Electronics Corporation and also includes its majority-owned subsidiaries.

(Note 2) "Renesas Electronics product(s)" means any product developed or manufactured by or for Renesas Electronics.



Renesas Electronics Corporation
www.renesas.com