

XMC4300 Relax EtherCAT[®] Kit

For XMC4000 family

About this document

Scope and purpose

This document provides a hardware description of the XMC4300 Relax EtherCAT[®] Kit including schematics and list of material. For fast software development you can find the mapping of XMC4300 functions to the on-board components in various tables.

Intended audience

This document is intended for anyone who wants to develop software on the XMC4300 Relax EtherCAT[®] Kit or wants to use this kit for evaluating and demonstrating the capabilities of the XMC4300 microcontroller.

Table of contents

	About this document	1
	Table of contents	2
1	Introduction	2
1.1	Key features	3
1.2	Block diagram	4
2	Hardware description	4
2.1	Power supply	5
2.2	Arduino compatible connector	6
2.3	mikroBUS™ socket	7
2.4	User push buttons and user LEDs	8
2.5	Debugging and UART-to-USB communication	9
2.5.1	On-board debug probe	9
2.5.2	Cortex® debug connector (10-pin)	9
2.6	Reset	10
2.7	CAN transceiver	10
2.8	Phy-2-Phy EtherCAT® connection	10
3	Production data	11
3.1	Schematics	11
3.2	Components placement and geometry	23
3.3	Bill of material	26
	Revision history	29
	Disclaimer	30

1 Introduction

This document describes the features and hardware details of the XMC4300 Relax EtherCAT® Kit equipped with an ARM® Cortex®-M4 based XMC™ microcontroller from Infineon Technologies AG.

It can be used with a wide range of development tools including Infineon's free of charge Eclipse based IDE DAVE™. The XMC4300 Relax EtherCAT® Kit is designed to evaluate the capabilities of the XMC4300 microcontroller especially in EtherCAT® slave applications. Table 1 shows the kit specification.

Table 1 Kit specification

Processor	Infineon's ARM® Cortex®-M4 XMC4300 microcontroller running at 144 MHz in LQFP100 package (order number XMC4300-F100K256)
Flash memory	256 kB
Data memory	128 kB
Dimensions	75 x 138 mm (91 x 144mm with connectors incl. Phy-2-Phy)

(table continues...)

1 Introduction

Table 1 (continued) Kit specification

Clock crystals	12 MHz and 32.768 kHz crystal for CPU
Power	<ul style="list-style-type: none"> Via USB connector (Micro-AB USB) or Via On-Board Debugger (Micro-AB USB)
Connectors	<ul style="list-style-type: none"> EtherCAT® Slave IN and OUT interface via RJ45 jack mikroBUS™ socket (2x8-pin) Arduino compatible connectors (1x10-pin, 2x8-pin, 1x6pin, 2x3pin) USB connector (Micro-AB USB) CAN connector (D-Sub DE-9) EtherCAT® Phy-2-Phy connector (not assembled) Serial Wire Debug interface (2x5, 50 mil pitch) to XMC™ (not assembled) (on board debugger can be overridden by externally connected debugger)
Debugger	On-Board J-Link debug probe via USB supporting <ul style="list-style-type: none"> Serial Wire Debug (SWD) UART-to-USB bridge (virtual COM)
Others	<ul style="list-style-type: none"> On-board debug probe, based on XMC4200 microcontroller 2x EtherCAT® Phys CAN transceiver 2 user push-buttons, 2 user LED Reset push-button

1.1 Key features

The XMC4300 Relax EtherCAT® Kit has the following key features and components:

- XMC4300 microcontroller (ARM® Cortex®-M4 based), 144 MHz, 256 kB Flash, 128 kB SRAM, LQFP100 package
- On-board debug probe with USB interface supporting SWD + SWO
- Virtual COM port via on-board debug probe
- EtherCAT® slave components: 2 EtherCAT® phys and 2 RJ45 jacks
- Prepared for EtherCAT® Phy-2-Phy connection for backplane applications (assembly option)
- Arduino compatible connector and voltage level shifter for 3.3 V / 5 V Arduino shields
- mikroBUS™ socket for plug-and-play click boards™
- CAN transceiver and CAN connector (D-Sub DE-9)
- USB interface (Micro-AB USB plug)
- Voltage regulator 5 V -> 3.3
- 2 x User push-buttons
- 2 x User LED
- Reset push-button
- 12 MHz crystal
- 32.768 kHz RTC crystal

2 Hardware description

1.2 Block diagram

The block diagram in [Figure 1](#) shows the main components of the XMC4300 Relax EtherCAT® Kit and their interconnections.

There are following main building blocks:

- XMC4300 microcontroller in a LQFP100 package
- On-board USB debug probe based on XMC4200 for SWD, SWV and Virtual COM port support
- 2 EtherCAT® Phy with 2 RJ45 plugs
- Connection Header for Arduino
- mikroBUS™ socket
- 2 User push-buttons, 2 User LEDs, Reset push-button
- Micro-AB USB Plug
- CAN transceiver

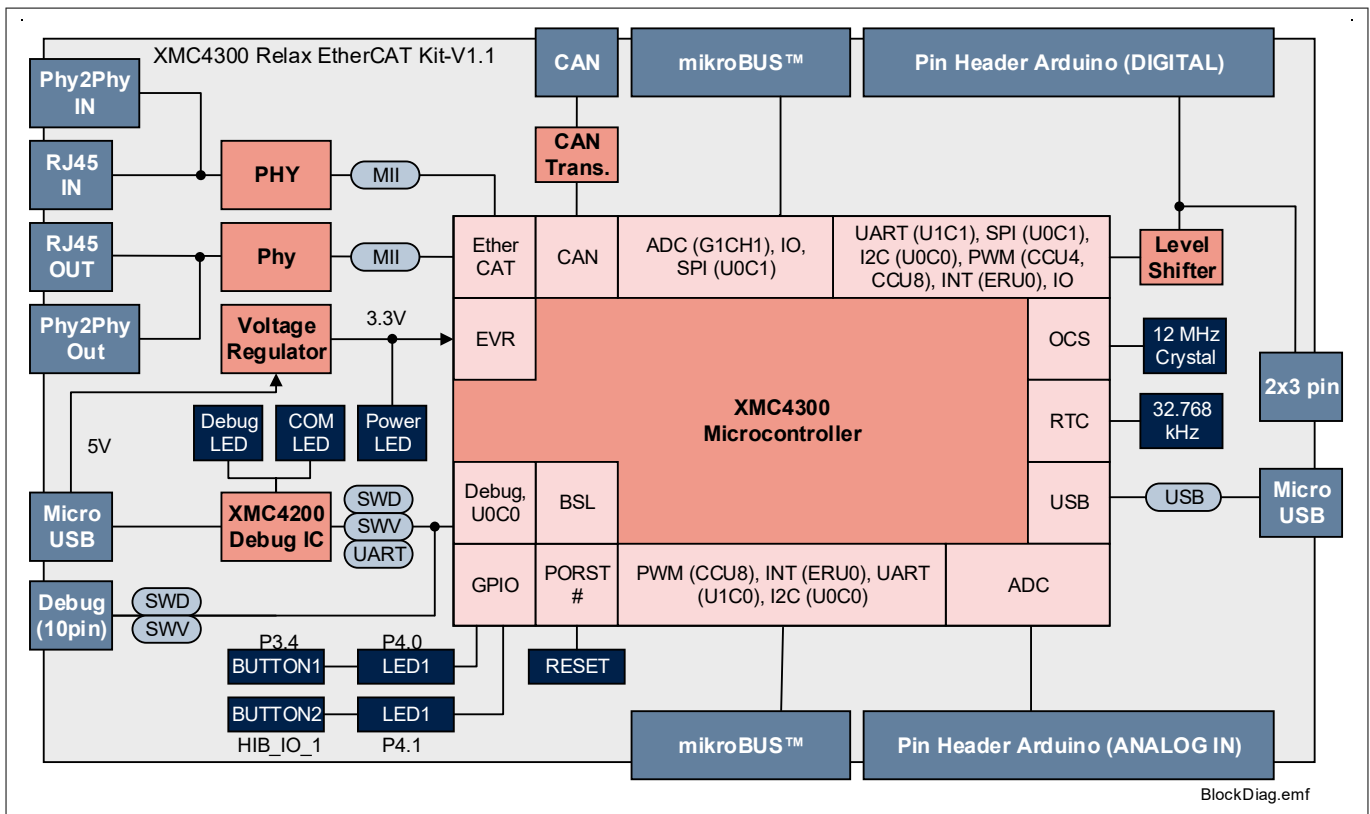

Figure 1 Block diagram of the XMC4300 Relax EtherCAT® Kit

2 Hardware description

The following chapters provide a detailed description of the hardware and how it can be used. The hardware is depicted in [Figure 2](#).

2 Hardware description

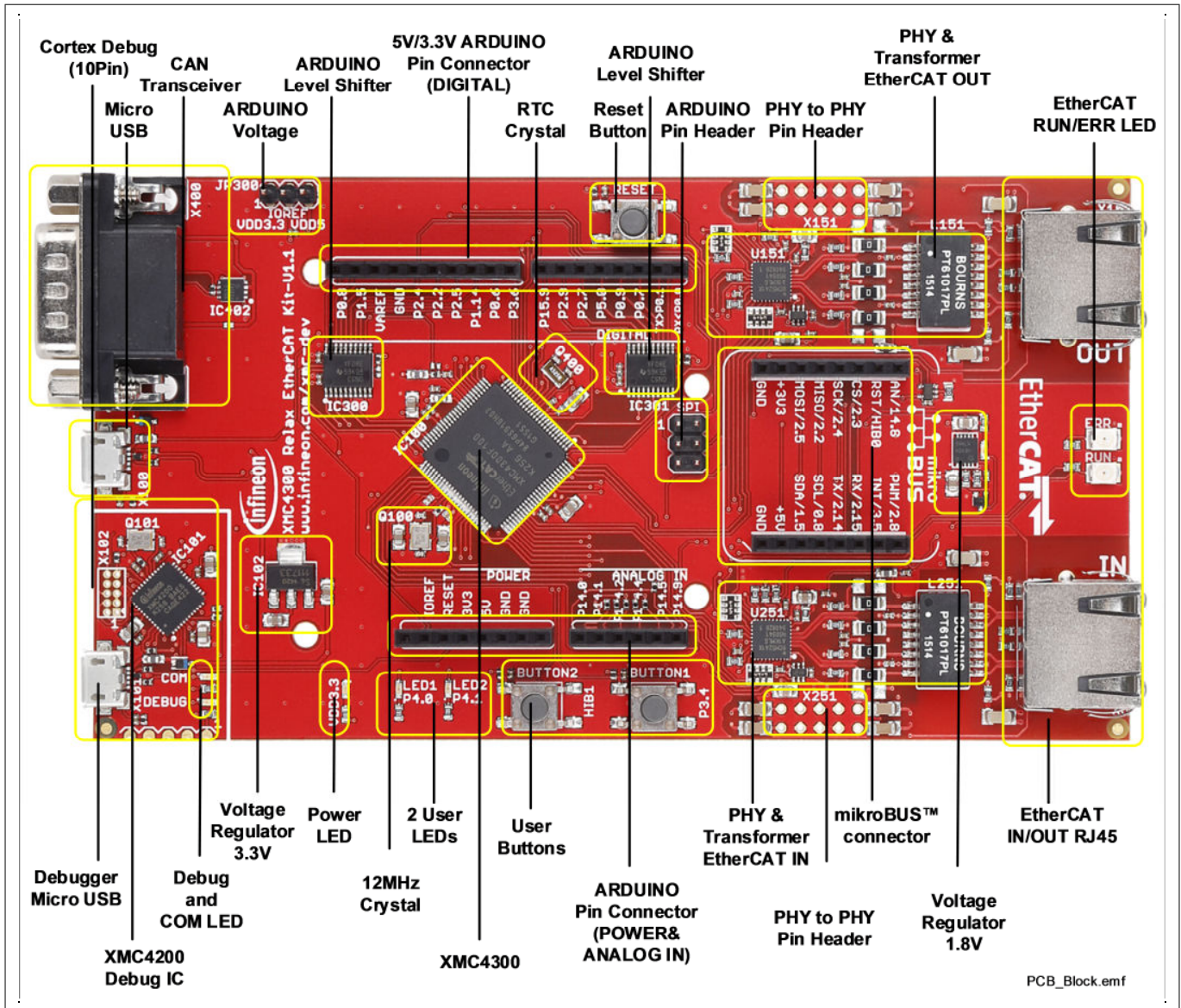

Figure 2 PCB of the XMC4300 Relax EtherCAT® kits

2.1 Power supply

The XMC4300 Relax EtherCAT® Kit must be supplied by an external 5 volt DC power supply connected to any of the micro USB plugs (X100, X101). Out of the box with the pre-programmed EtherCAT® slave application and the on-board debug probe in operation, the XMC4300 Relax EtherCAT® Kit typically draws about 440 mA in an EtherCAT® environment. This current can be delivered via the USB plug of a PC, which is specified to deliver up to 500 mA. The green Power LED (VDD3.3) indicates the presence of the generated 3.3 V supply voltage.

On-board reverse current protection diodes will ensure safe operation when power is provided through both USB plugs at the same time. These protection diodes allows to use the on-board debug probe connected with a PC/Notebook via X101 and a second host PC/Laptop connected with the XMC4300 Relax EtherCAT® Kit via X100.

If the board is powered via a USB plug, it is not recommended to apply an additional 5 Volt power supply to one of the 5 Volt power pins (VDD5, 5 V) on the Arduino headers or mikroBUS™ socket, because there is no protection against reverse current into the external power supply. These power pins can be used to power an external circuit, but care must be taken not to draw more current than USB can deliver. A PC acting as a USB host can typically deliver up to 500 mA current. If higher currents are required and in order to avoid damage to the USB

2 Hardware description

host, the use of an external USB power supply which is able to deliver higher currents than 500 mA is strongly recommended.

After power-up the green DEBUG LED starts blinking. When there is a connection to a PC via the Debug USB plug X101 and the USB Debug Device drivers are installed on this PC, the DEBUG LED will turn from blinking to constant illumination.

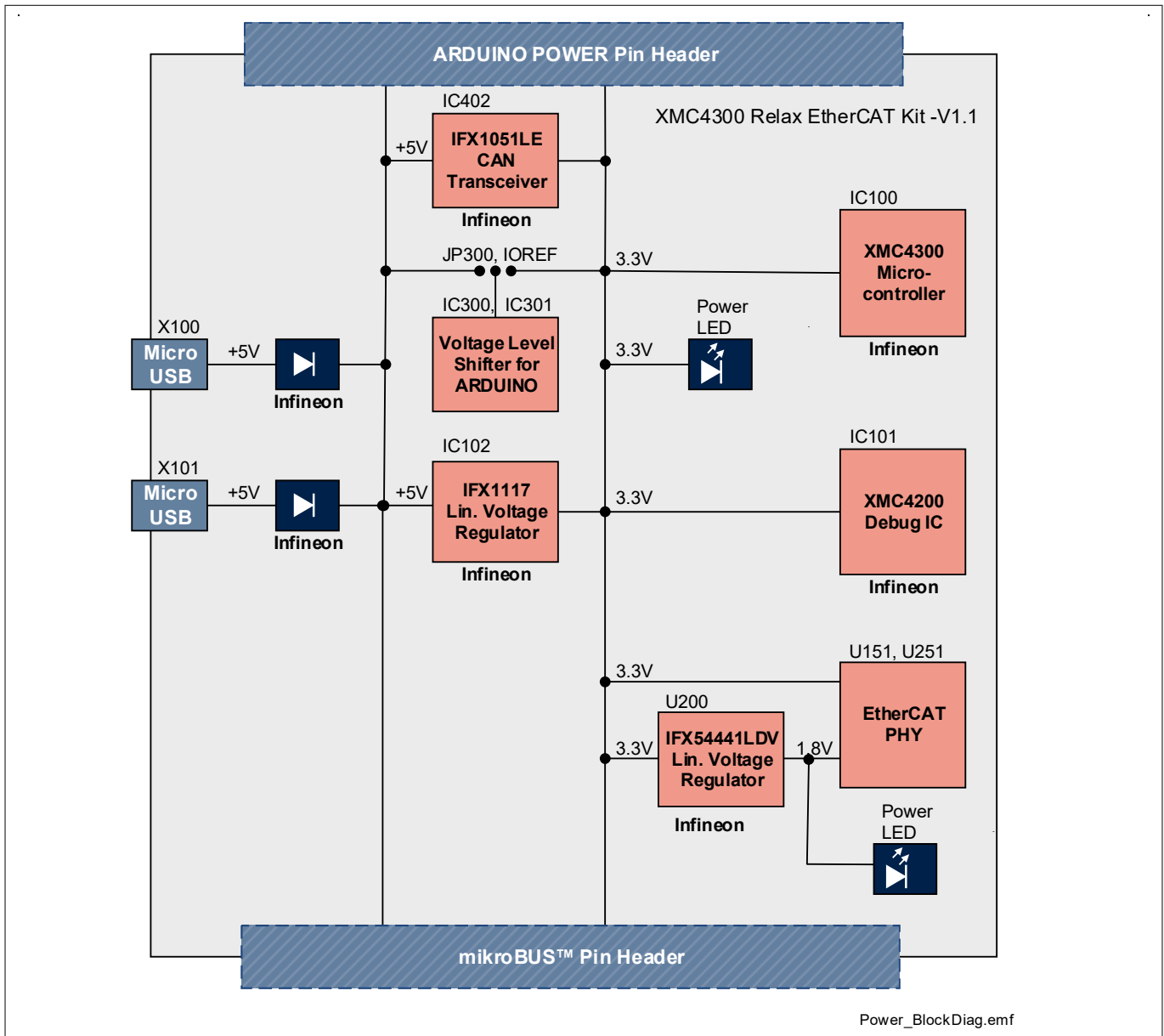

Figure 3 Power supply concept

2.2 Arduino compatible connector

The mapping of GPIOs and XMC™ pin functions to Arduino compatible functions can be found in [Figure 4](#). The Arduino compatible connector supports

- SPI interface (SPI_XXX)
- I2C interface (I2C_XXX)
- UART interface (UART_XXX)
- PWM signal outputs (PWM0-5)

2 Hardware description

- ADC input (ADC0-5)
- Interrupt input (INT0-1)
- Reset

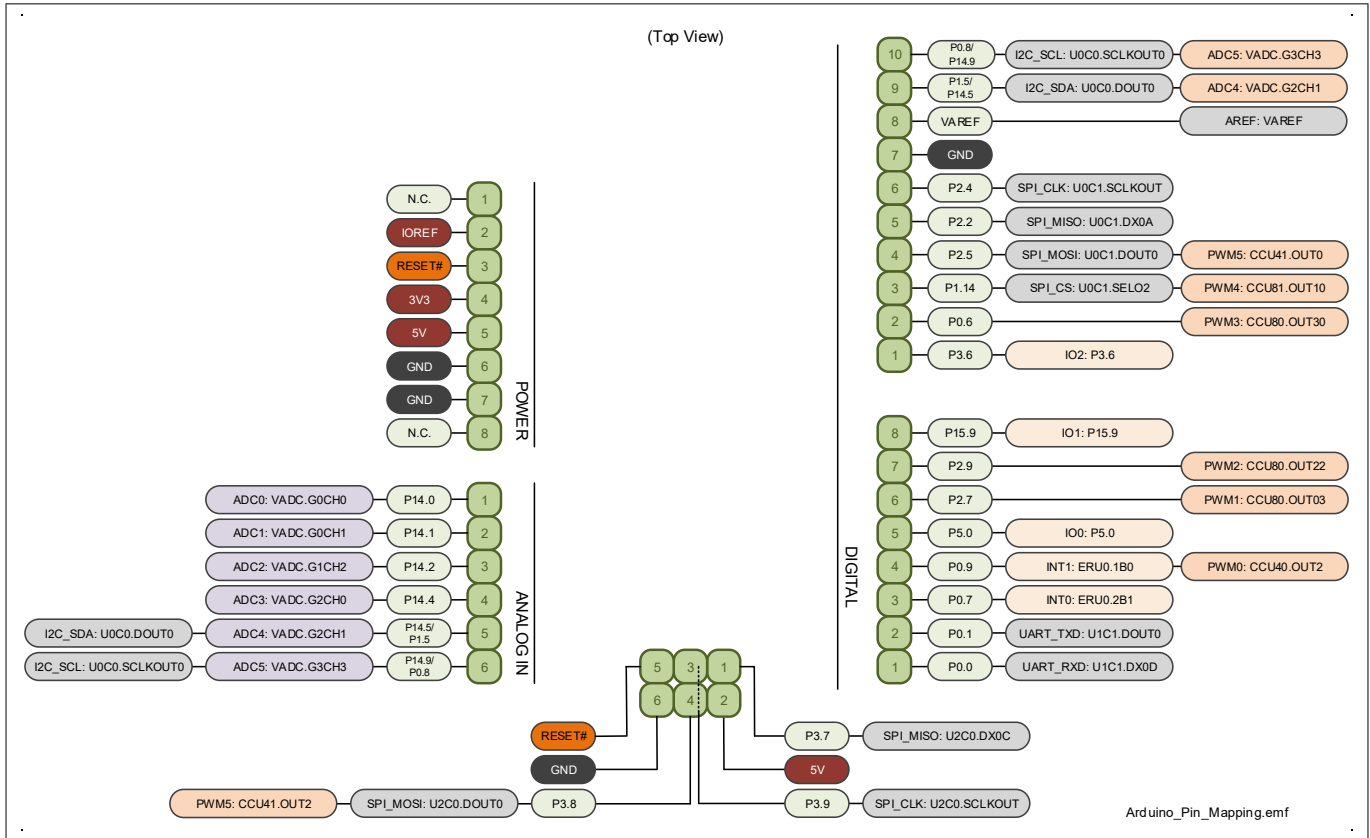

Figure 4 Mapping of Arduino™ functions to XMC™ pin functions

The XMC4300 Relax EtherCAT[®] Kit features a bi-directional voltage level shifter and therefore supports 5 V Arduino shields as well as 3.3 V Arduino shields. Jumper JP300 (IOREF) determines whether the Arduino shield is driven with 5 V or 3.3 V.

The analog input signals (ADC0-5) are limited to 3.3 V input voltage. A serial 100 Ohm resistor protects the analog input pin against overcurrent.

Primarily, ADC0 to ADC3 should be used as analog inputs, because there is no additional circuit connected to these pins, whereas ADC4 and ADC5 have additional circuitry and require an input signal with low input impedance (<500 Ohm).

Note: Parallel operation of I2C and ADC4/ADC5 is not possible, because they share the same Arduino pins.

2.3 mikroBUS™ socket

The mapping of GPIOs and XMC™ pin functions to mikroBUS™ functions can be found in [Table 5](#). The mikroBUS™ connector supports

- SPI interface with one chip select (SPI_XXX)
- I2C interface (I2C_XXX)
- UART interface (UART_XXX)
- PWM signal output (PWM)
- ADC input (ADC)

2 Hardware description

- Interrupt input (INT)
- Reset (RST)

Attention: *Jumper JP300 (IOREF) must be set to 3.3 V (VDD3.3) when using click™ boards. 5 V click™ boards cannot be used with the XMC4300 Relax EtherCAT® Kit.*

Note: *The mikroBUS™ UART and debugger’s UART shares the same USIC channel (U1C0) of the XMC4300 device, but do not share the same pins. Parallel operation by time multiplexing is possible.*

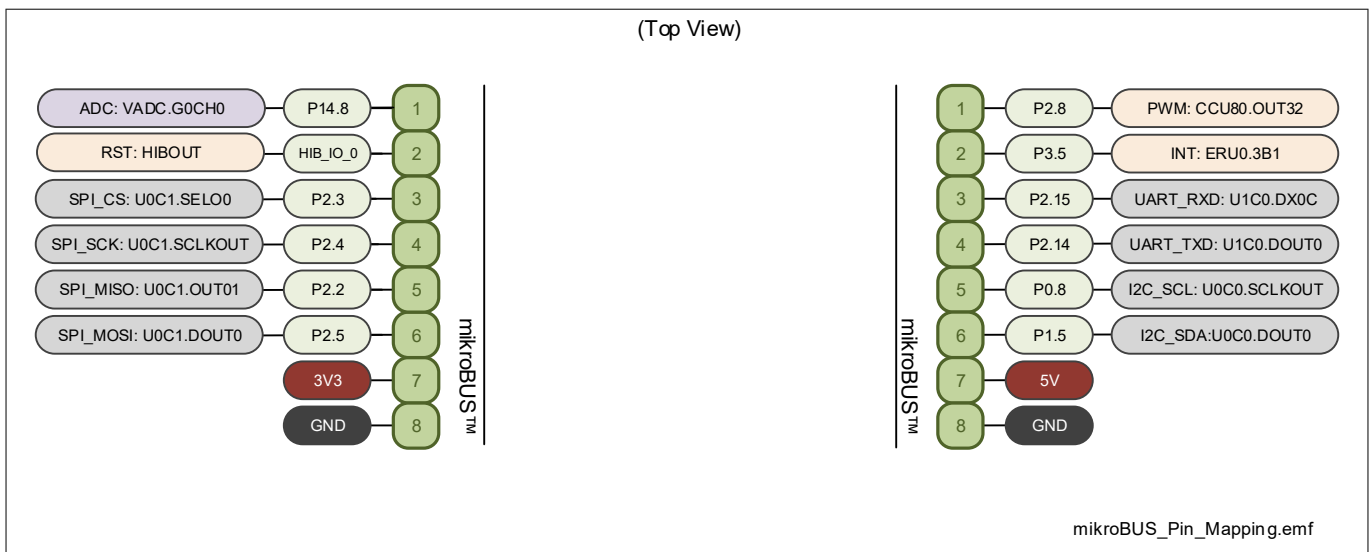

Figure 5 Mapping of Arduino™ functions to XMC™ pin functions

2.4 User push buttons and user LEDs

The XMC4300 Relax EtherCAT® Kit provides two push buttons and two LEDs. The port pins used can be found in [Table 2](#) and [Table 3](#). These pins are used exclusively for this function and they are not mapped to other devices or connectors.

Table 2 XMC4300 pin mapping for user LEDs

LED	XMC™ pin
LED1	P4.0
LED2	P4.1

Table 3 XMC4300 pin mapping for user push buttons

Button	XMC™ pin
BUTTON1	P3.4
BUTTON2	HIB_IO_1

2 Hardware description

2.5 Debugging and UART-to-USB communication

The XMC4300 Relax EtherCAT® Kit supports debugging via 2 different channels:

- On-board debug probe
- 10-pin Cortex® Debug connector (not assembled)

2.5.1 On-board debug probe

The on-board debug probe supports Serial Wire Debug (SWD) and UART communication. Both require the installation of Segger's J-Link Driver which is part of the DAVE™ installation. DAVE™ is a highly efficient development platform for the XMC® microcontroller families to simplify and shorten software development. It can be downloaded at <http://www.infineon.com/dave>. The latest Segger J-Link Driver can be downloaded at <http://www.segger.com/jlink-software.html>. Table 4 shows the pin assignment of the XMC4300 used for debugging and UART communication.

Table 4 XMC4300 pins mapping for debugging and UART-communication

Pin function	Input/Output	XMC™ Pin
Data pin for debugging via SWD	I/O	TMS
Clock pin for debugging via SWD	O	TCK
Transmit pin for UART communication (PC_RXD)	O	P0.5 (U1C0.DOUT0)
Receive pin for UART communication (PC_TXD)	I	P0.4 (U1C0.DX0A)

2.5.2 Cortex® debug connector (10-pin)

The 10-pin Cortex® debug connector supports Serial Wire Debug (SWD) and Serial Wire Viewer (SWV). The pin assignment of the Cortex® debug connector is shown in Table 5.

Table 5 Pin assignment of the Cortex® Debug Connector (X102)

Pin No.	Signal name	Description
1	VCC	+3.3 V
2	TMS	Serial Wire Data I/O
3	GND	Ground
4	TCK	Serial Wire Clock
5	GND	Ground
6	SWV	Serial Wire Viewer (Trace Data Out
7	Key	Key
8	NC	Not connected
9	GND_Detect	Ground detect
10	RESET	Reset (active low)

2 Hardware description

2.6 Reset

The reset pin (PORST#) of the XMC4300 is a bi-directional pin in open drain mode. An internal pull-up resistor keeps the PORST# pin high during normal operation. A low level at this pin will force a hardware reset. In case of a MCU internal reset the PORST# pin will drive a low signal.

A reset signal can be issued by

- the on-board Reset Button (SW102, “RESET”)
- the on-board debug probe (IC101.46)
- the external debugger connected to the 10-pin Cortex® debug probe connector (X102)
- the Arduino Power Header (RESET)
- the mikroBUS™ socket (RST)

An XMC™ internal circuit always ensures a safe Power-on-Reset. The XMC™ does not require any additional external components to generate a reset signal during power-up.

2.7 CAN transceiver

The XMC4300 Relax EtherCAT® Kit provides a CAN interface via a D-Sub DE-9 connector. Infineon’s high speed CAN transceiver {IFX1051LE) for industrial applications supports 3.3V I/O logic and is suitable for 12 V and 24 V bus systems with an excellent EMC performance. The CAN bus (signals CANH, CANL) are terminated by a 120 Ohm resistor.

Table 6 CAN signals and XMC4300 pin mapping

Signal name	Pin no. at D-Sub DE-9 (X400)	XMC™ Pin, XMC™ function
CANH	X400.7	-
CANL	X400.2	-
CAN_TX	-	P2.0, CAN.N0_TXD
CAN_RX	-	P14.3, CAN.N0_RXDB
GND	X400.3, X400.6	-
VDD5	X400.9 (needs to be connected)	-

2.8 Phy-2-Phy EtherCAT® connection

For backplane/mid-plane oriented EtherCAT® applications, communication can be implemented without using isolation transformers. Instead, low-cost ceramic capacitors can be used. The PCB layout of the XMC4300 Relax EtherCAT® Kit has been prepared for EtherCAT® operation through direct Phy-2-Phy connection.

For this purpose two XMC4300 Relax EtherCAT® kits are required and some modifications must be made to the kits (see [Figure 6](#)). All components required for this modification can be found attached to the kit.

- Remove four 0 Ohm resistors from each XMC4300 Relax EtherCAT® Kit
- Solder two 0 Ohm resistors onto each XMC4300 Relax EtherCAT® Kit
- Solder the connectors onto the XMC4300 Relax EtherCAT® Kits

Note: After this modification EtherCAT® communication through the RJ45 is disabled.

3 Production data

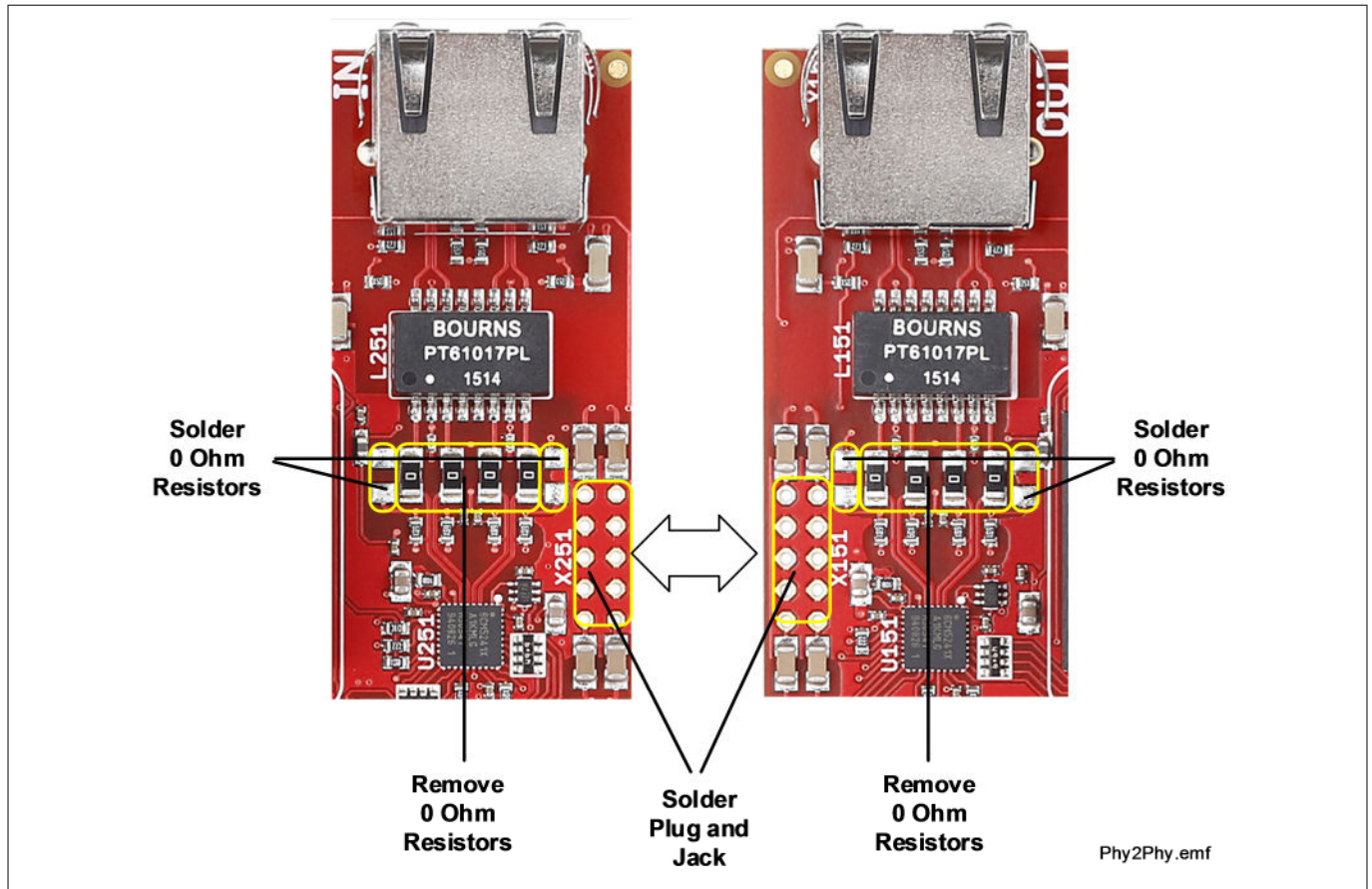

Figure 6 **Phy-2-Phy EtherCAT® connection between two XMC4300 Relax EtherCAT® Kits**

3 Production data

This chapter covers schematics, board dimensions, component placement and the bill of material.

3.1 Schematics

The following figures show the schematics of the XMC4300 Relax EtherCAT® Kit in hardware version 1.1:

- [Figure 7](#)
- [Figure 8](#)
- [Figure 9](#)
- [Figure 10](#)
- [Figure 11](#) (See Revision 1.1)
- [Figure 12](#) (See Revision 1.1)
- [Figure 13](#) (See Revision 1.1)
- [Figure 14](#) (See Revision 1.1)
- [Figure 15](#) (See Revision 1.2)
- [Figure 16](#) (See Revision 1.2)
- [Figure 17](#) (See Revision 1.2)
- [Figure 18](#) (See Revision 1.2)

3 Production data

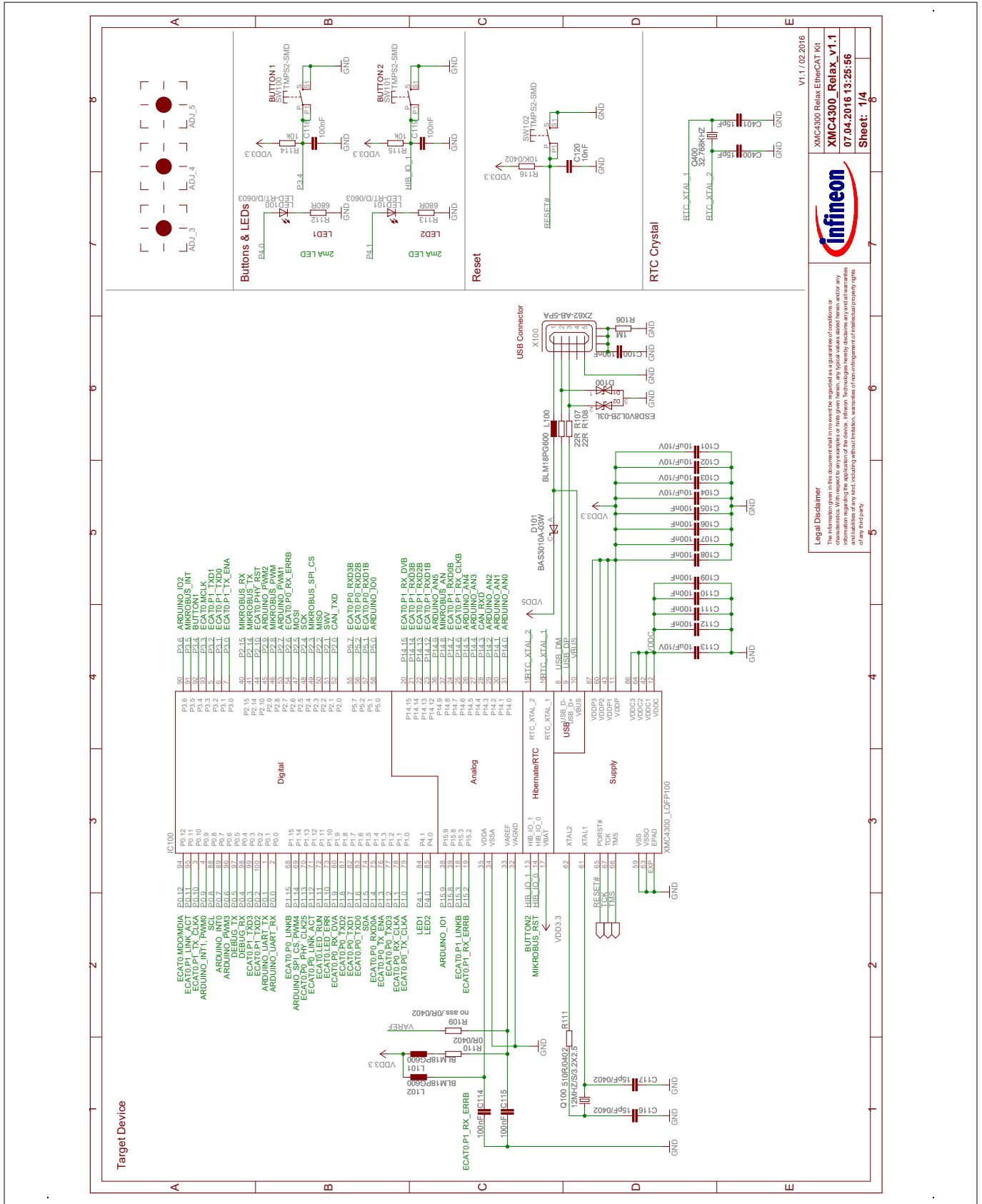

Legal Disclaimer
The information given in this document shall not be regarded as a guarantee of conditions or characteristics. With respect to any examples or tests given herein, any typical values stated herein and/or any information regarding the application of the device, Infineon Technologies hereby disclaims any and all warranties of any kind, including without limitation, the warranty of merchantability and fitness for any particular purpose.

Infineon
XMC4300 Relax EtherCAT Kit
07.04.2016 13:25:56
Sheet: 1/4

Figure 7 Schematic: MCU, Push Buttons, LEDs, Reset Button, Crystals, USB

3 Production data

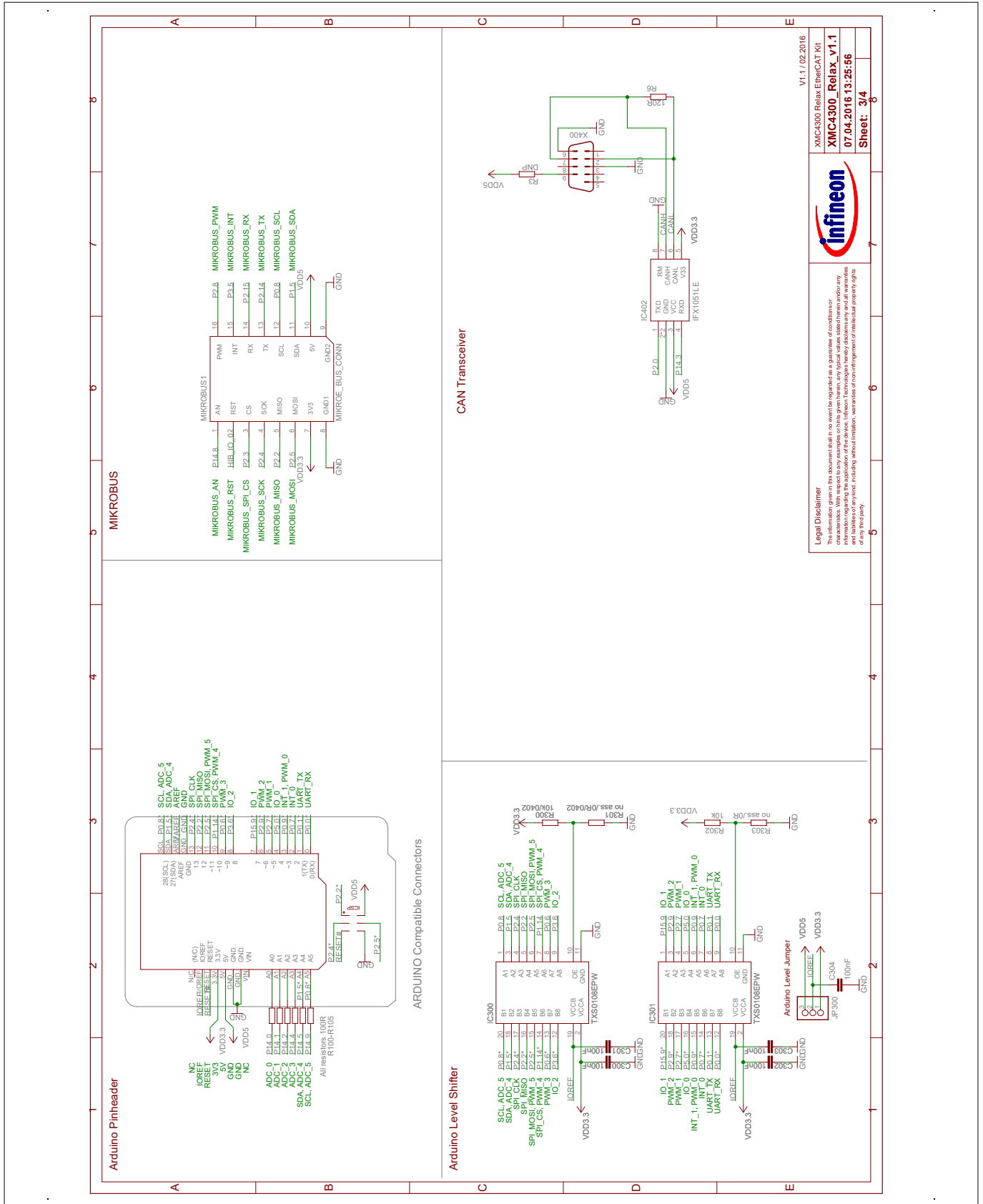
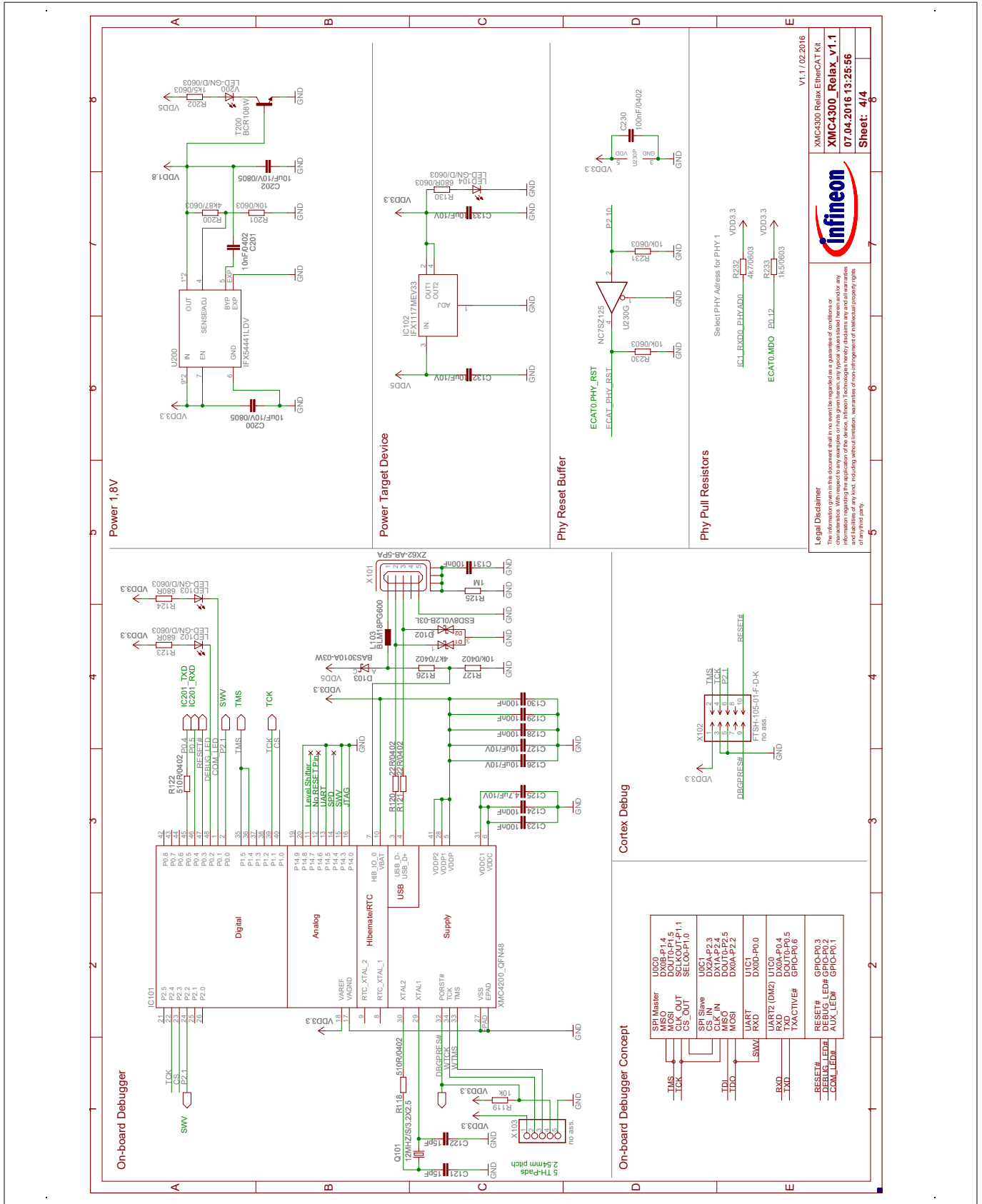

Figure 9 Schematic: Arduino, mikroBUS, CAN

3 Production data



Legal Disclaimer
The information given in this document shall be no way be regarded as a guarantee of conditions or characteristics. With respect to any examples or figures herein, any typical values stated herein and/or any information regarding the application of the devices, Infineon Technologies hereby disclaims any and all warranties of any kind, including accuracy, completeness, timeliness, non-infringement, intellectual property rights or otherwise.

Infineon
XMC4300 Relax EtherCAT Kit
07.04.2016 13:25:56
Sheet: 4/4

Figure 10 Schematic: On-Board Debug Probe, Power Supply

3 Production data

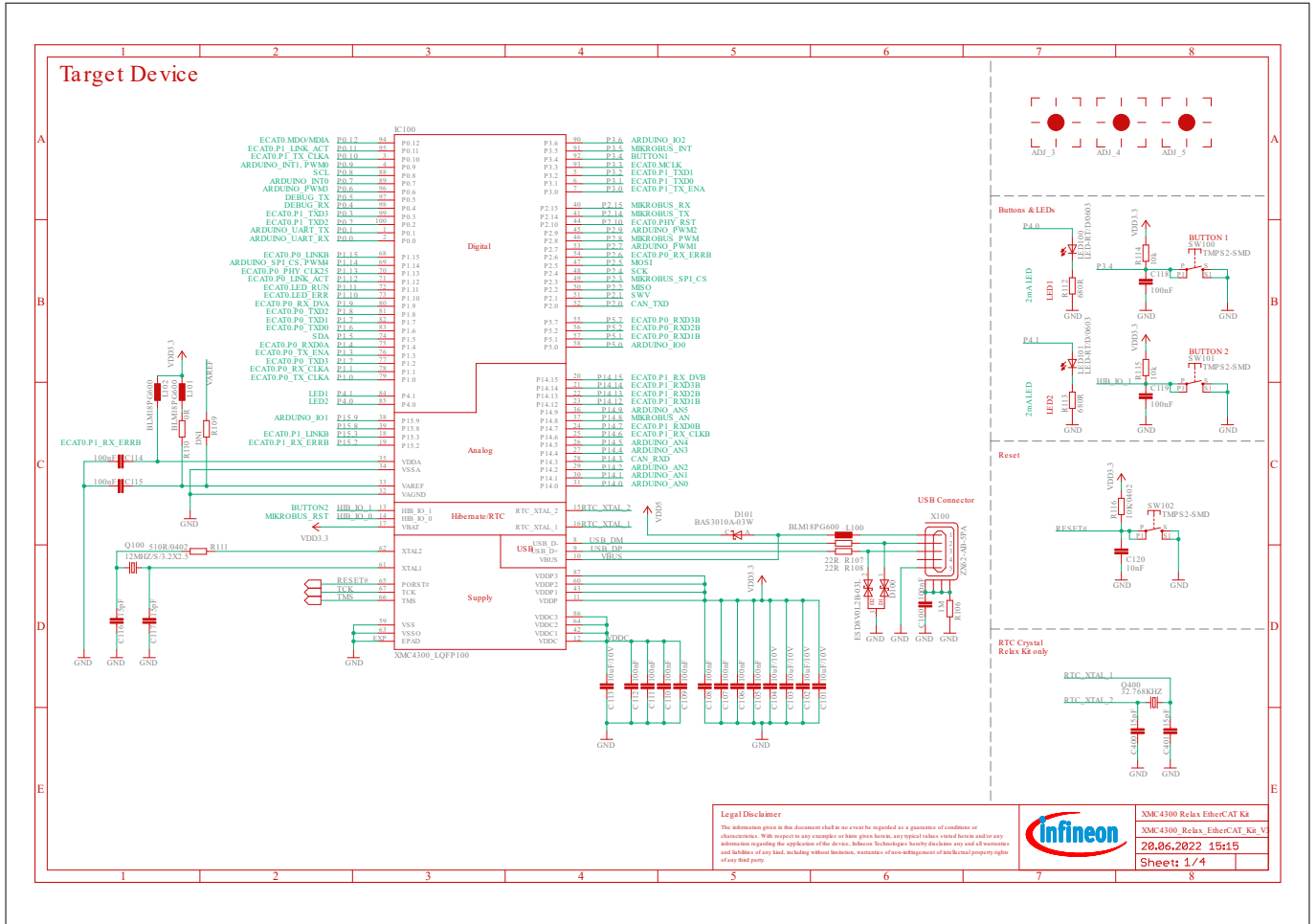

Figure 11 Schematic: MCU, Push Buttons, LEDs, Reset Button, Crystals, USB (see revision Revision 1.1)

3 Production data

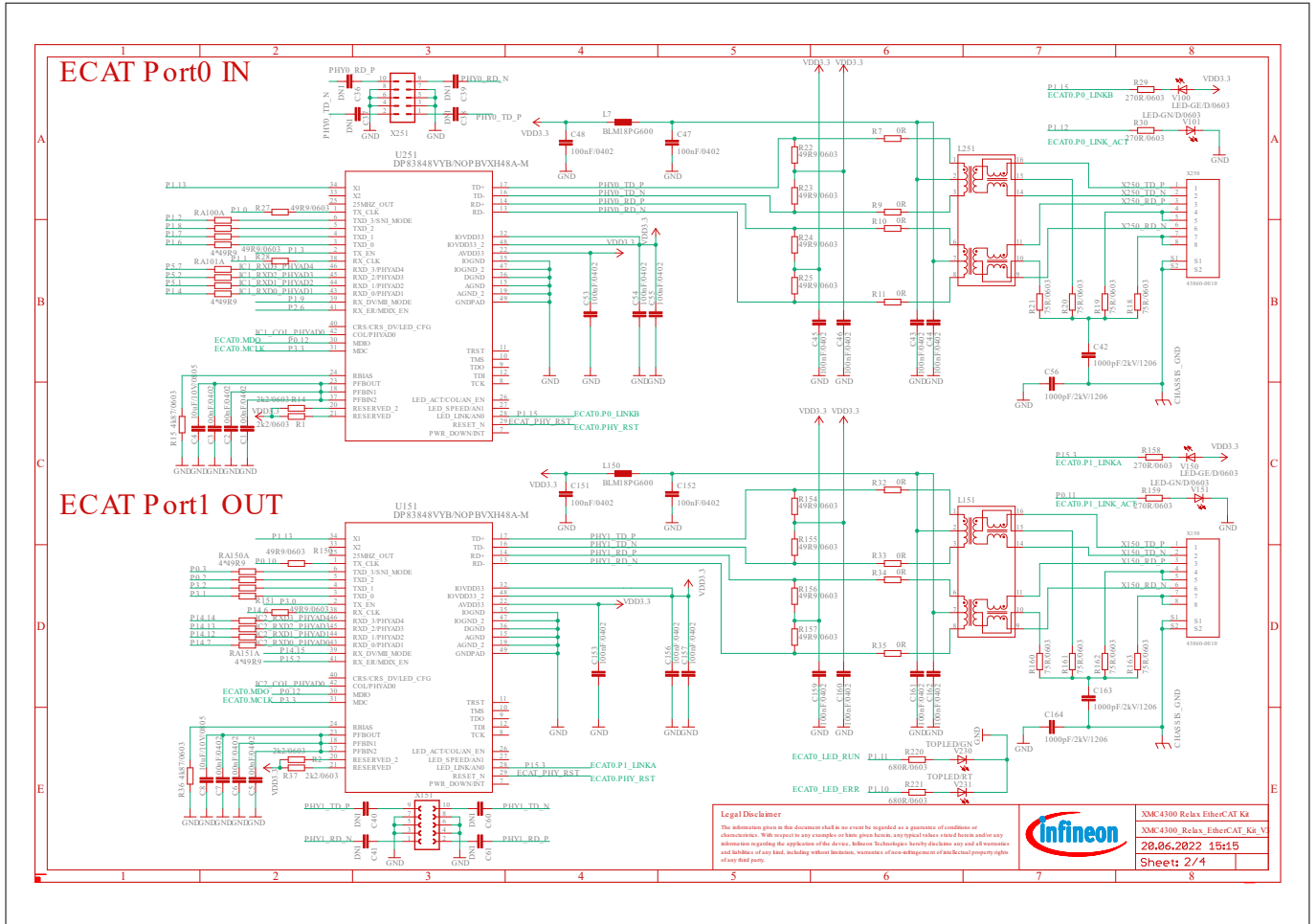

Figure 12 Schematic: EtherCAT® Phys, Magnetics, Phy-2-Phy (see revision Revision 1.1)

3 Production data

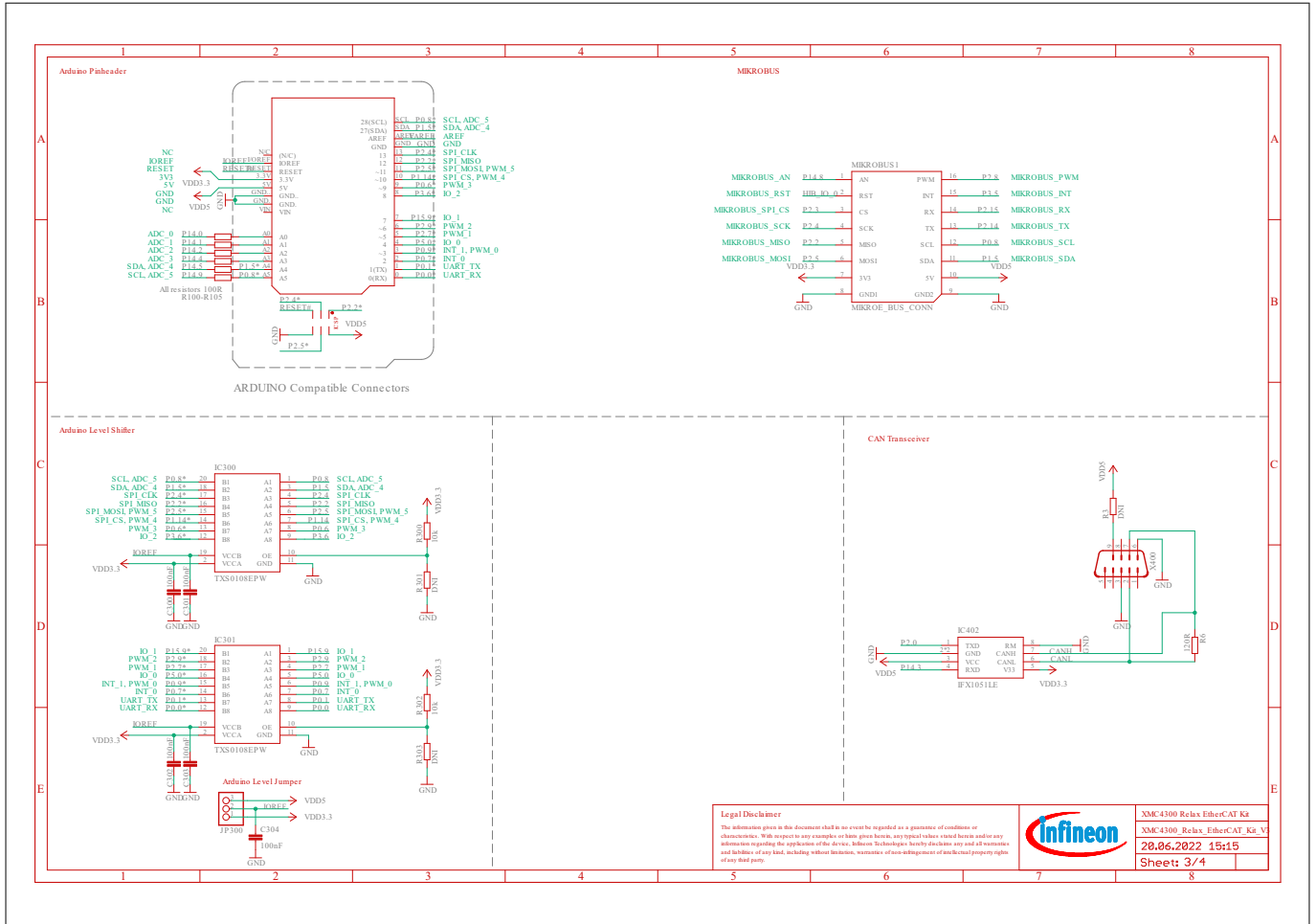

Figure 13 Schematic: Arduino, mikroBUS, CAN (see revision Revision 1.1)

3 Production data

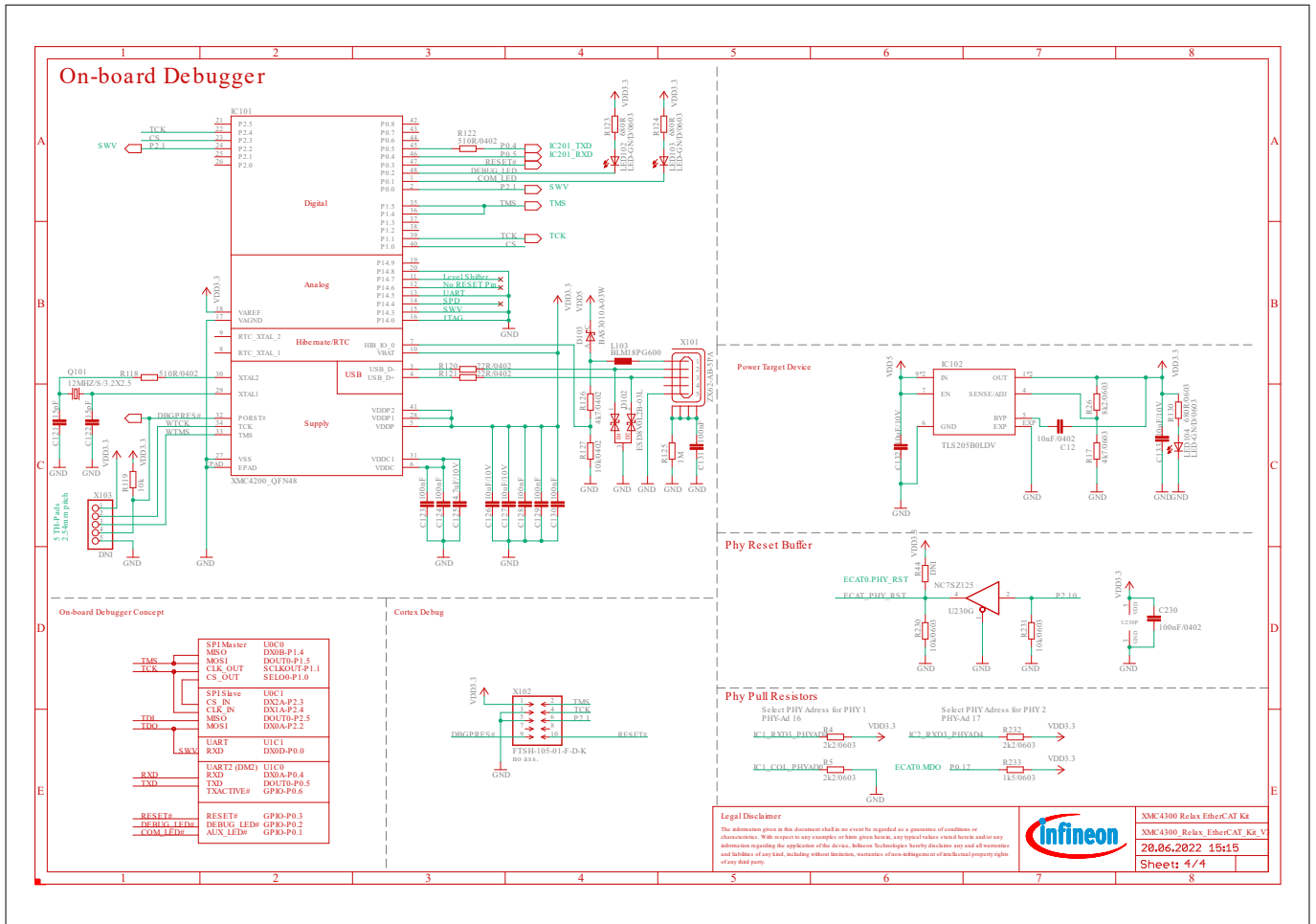

Figure 14 Schematic: On-Board Debug Probe, Power Supply (see revision Revision 1.1)

3 Production data

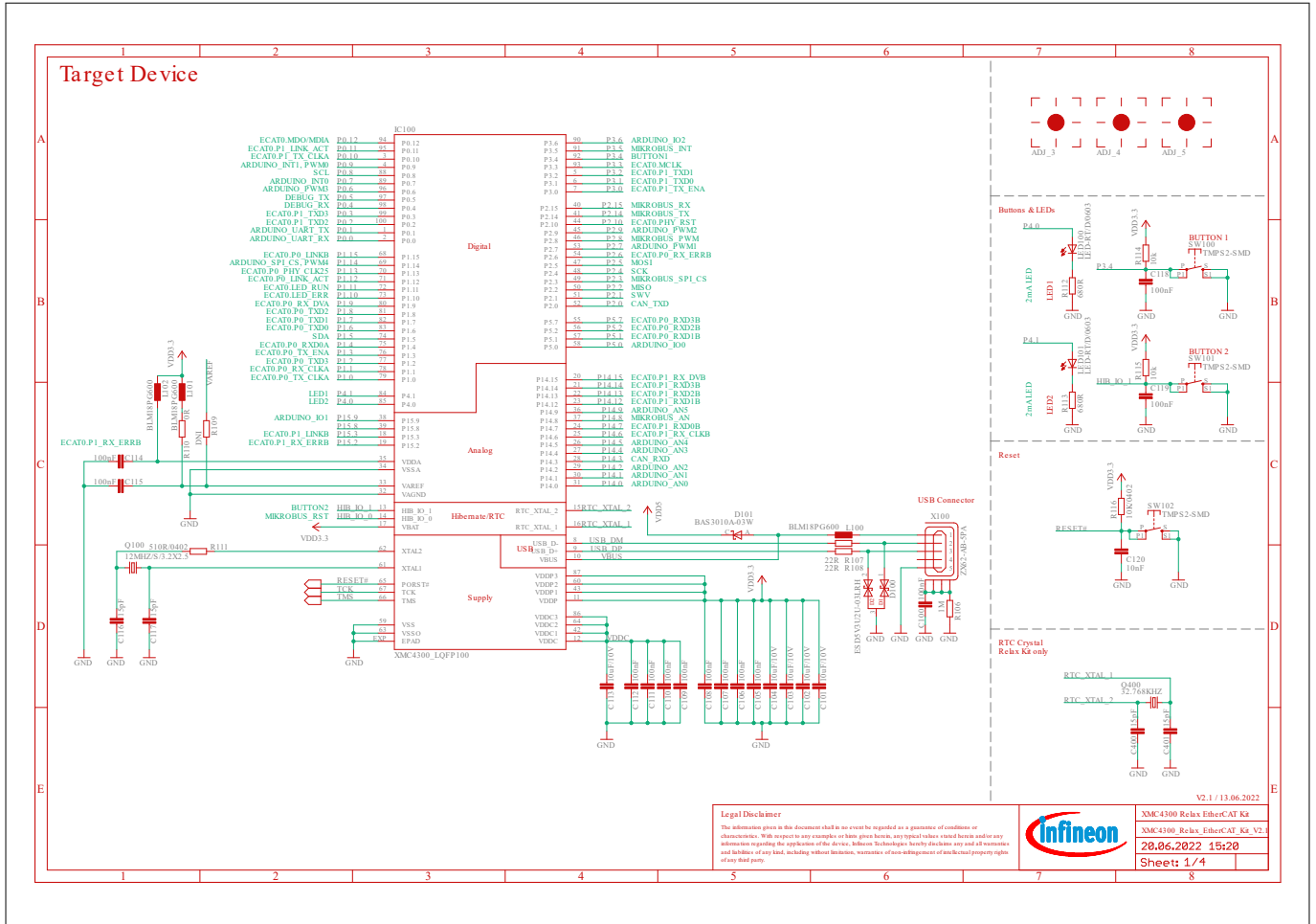

Figure 15 MCU, Push Buttons, LEDs, Reset Button, Crystals, USB (See Revision 1.2)

3 Production data

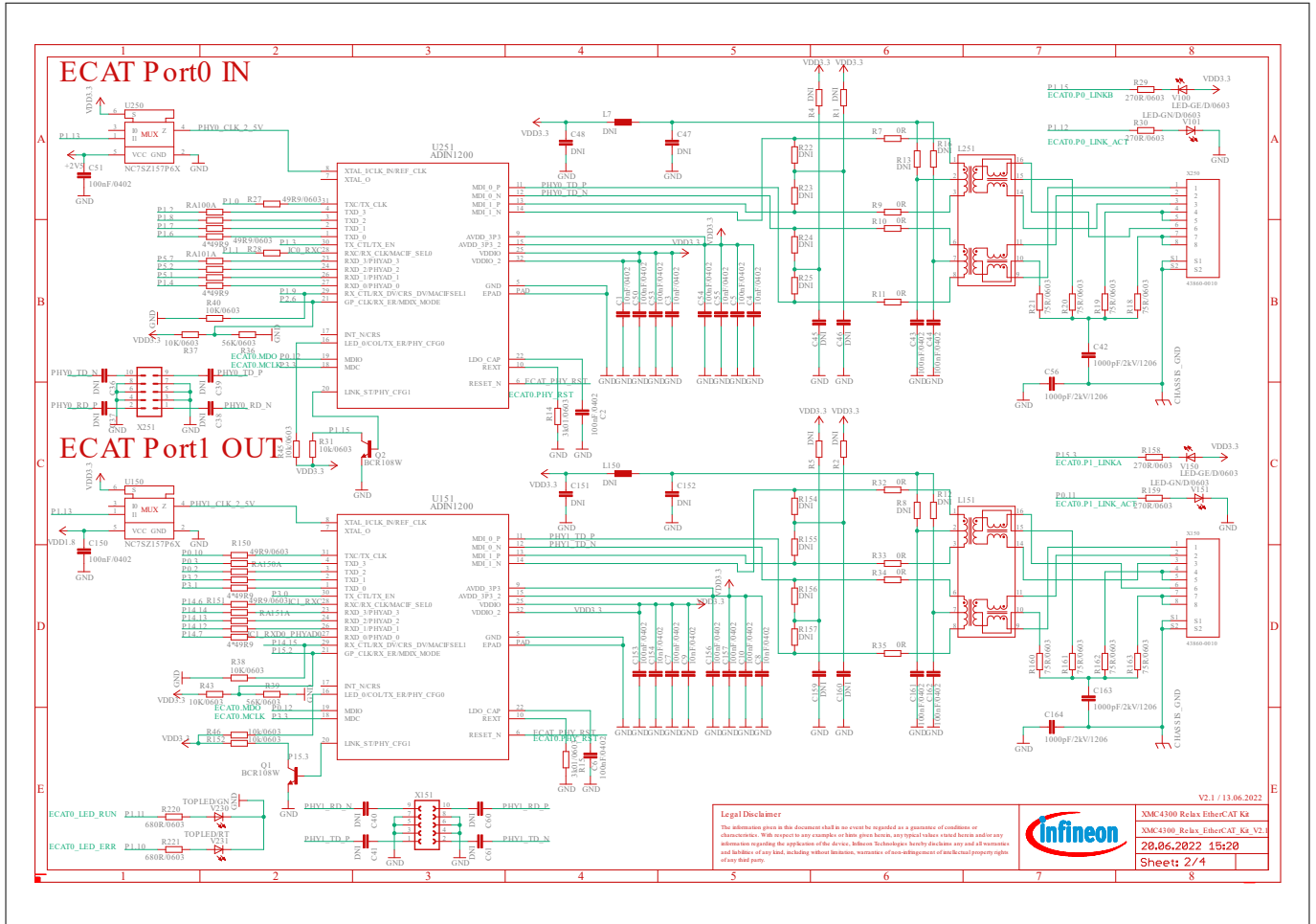

Figure 16 EtherCAT® Phys, Magnetics, Phy-2-Phy (See Revision 1.2)

3 Production data

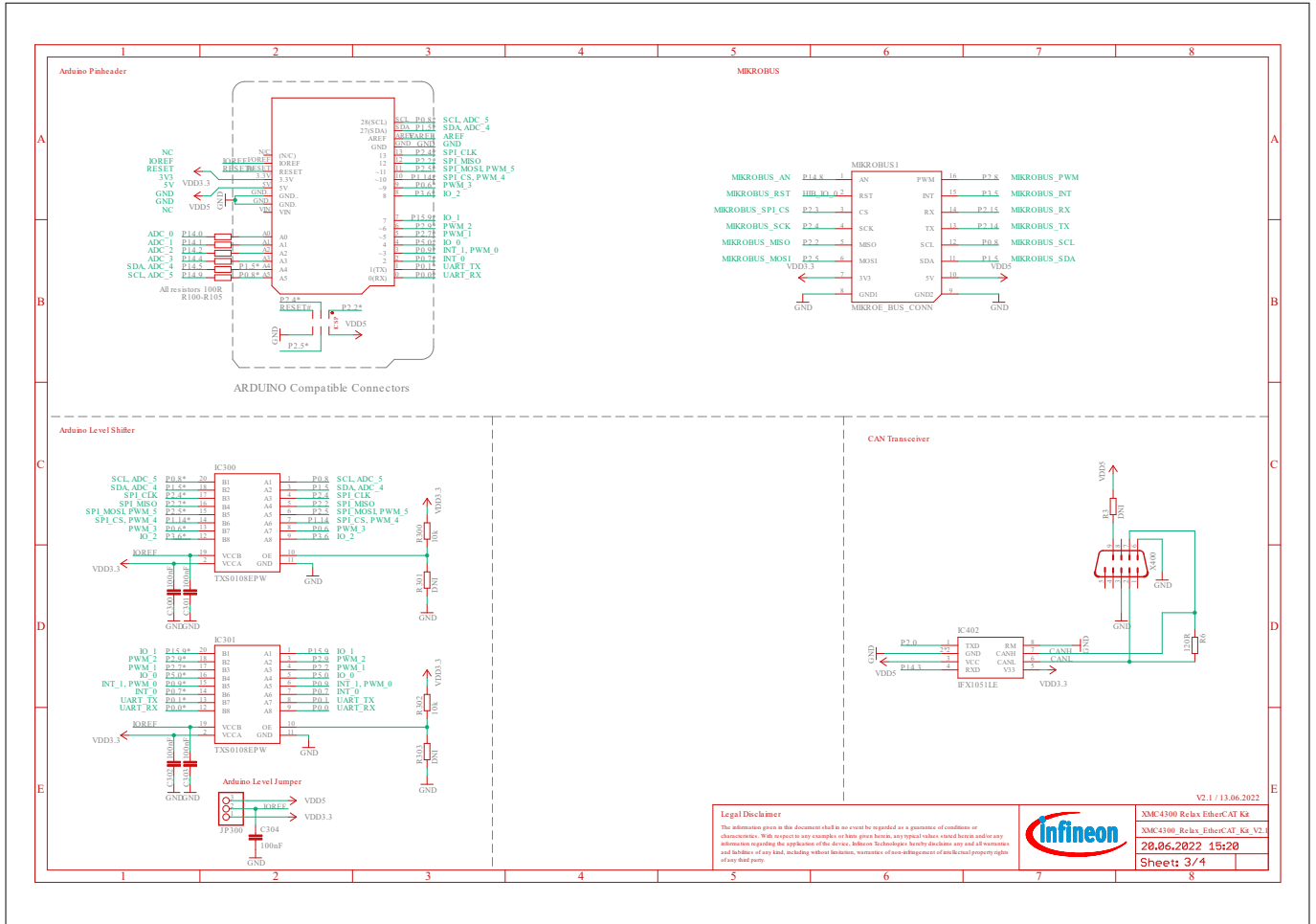

Figure 17 Arduino, mikroBUS, CAN (See Revision 1.2)

3 Production data

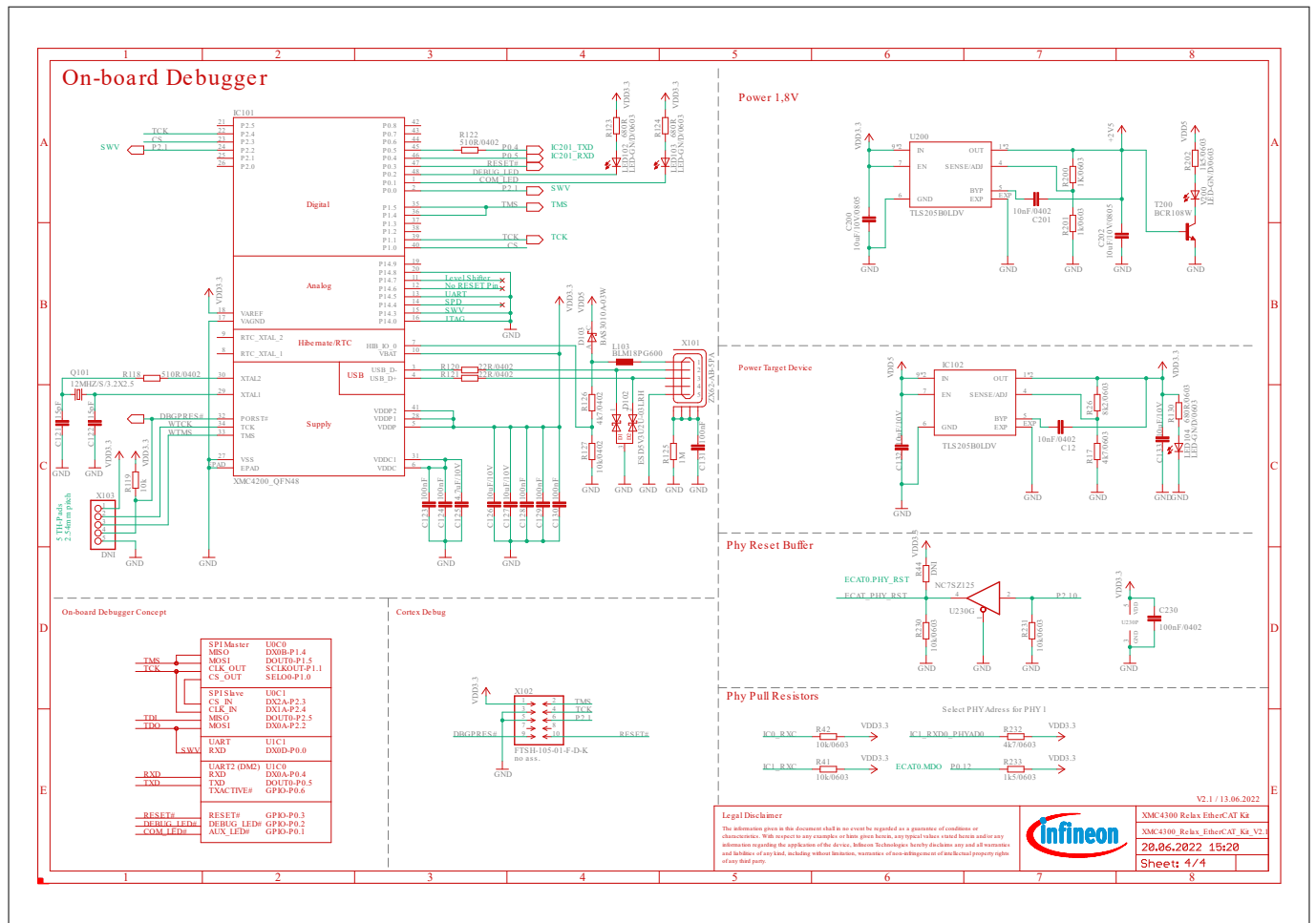

Figure 18 On-Board Debug Probe, Power Supply (See Revision 1.2)

3.2 Components placement and geometry

Figure 19 shows the board dimensions and the placement of components on the PCB.

3 Production data

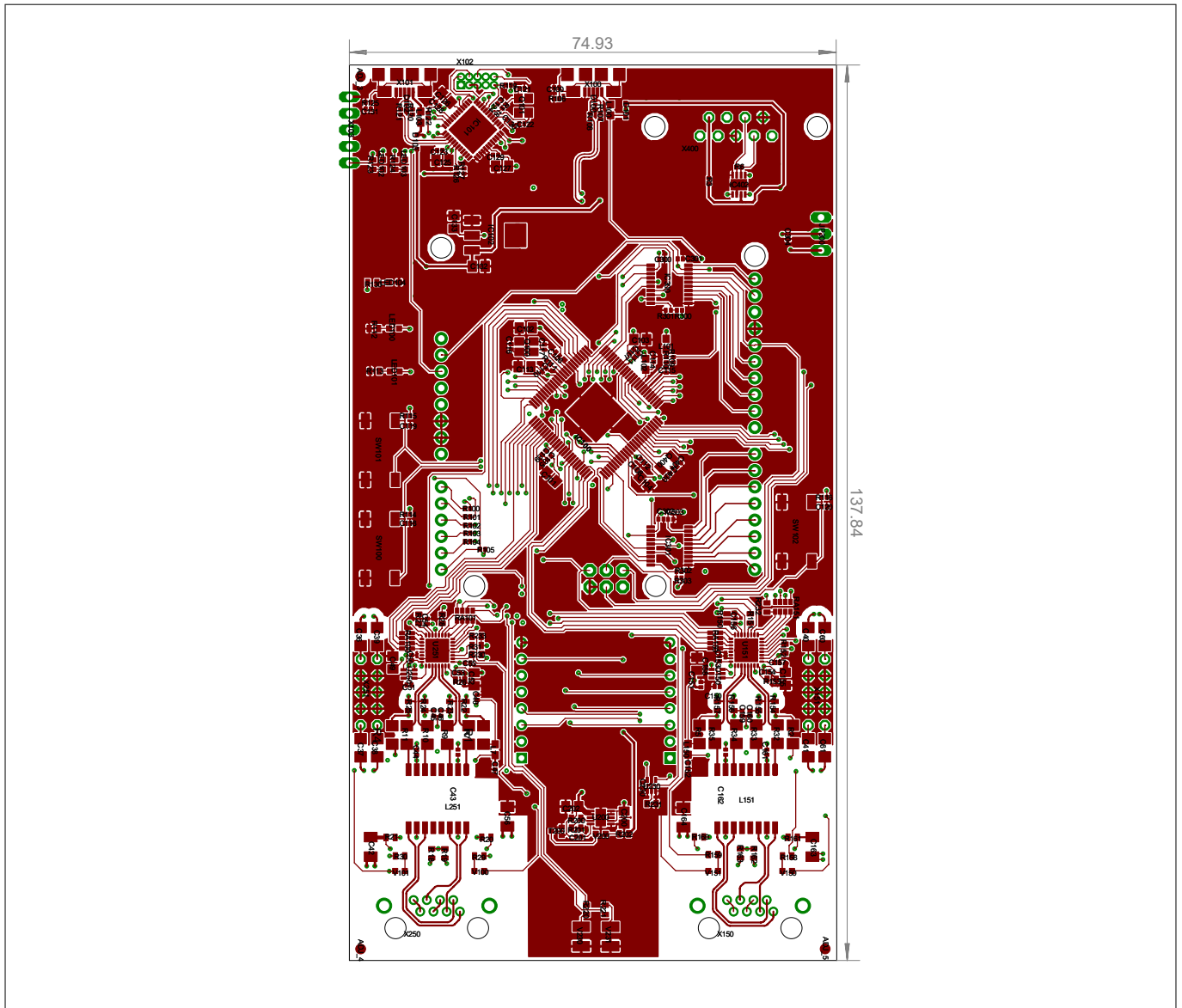

Figure 19 Components placement and geometry

3 Production data

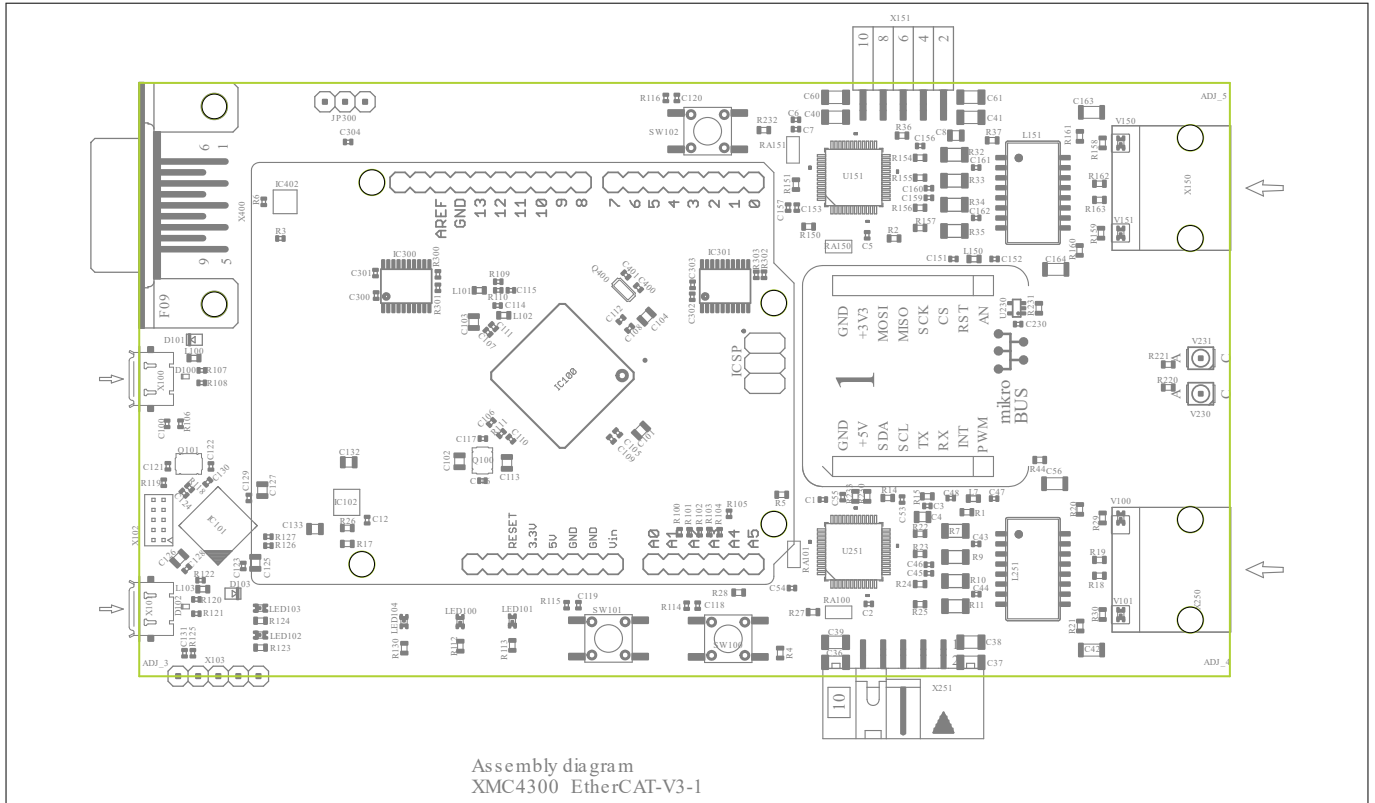

Figure 20 Assembly diagram 1 (see revision Revision 1.1)

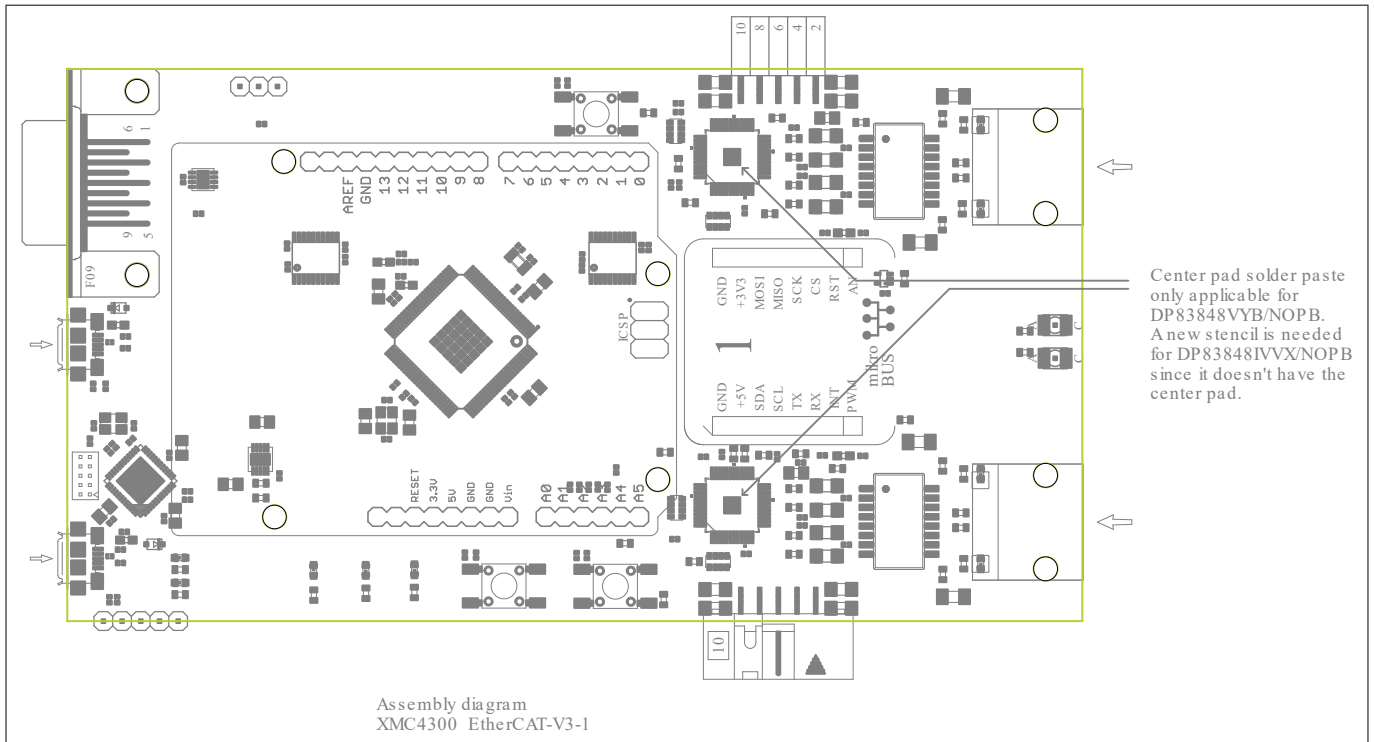

Figure 21 Assembly diagram 2 (see revision Revision 1.1)

3 Production data

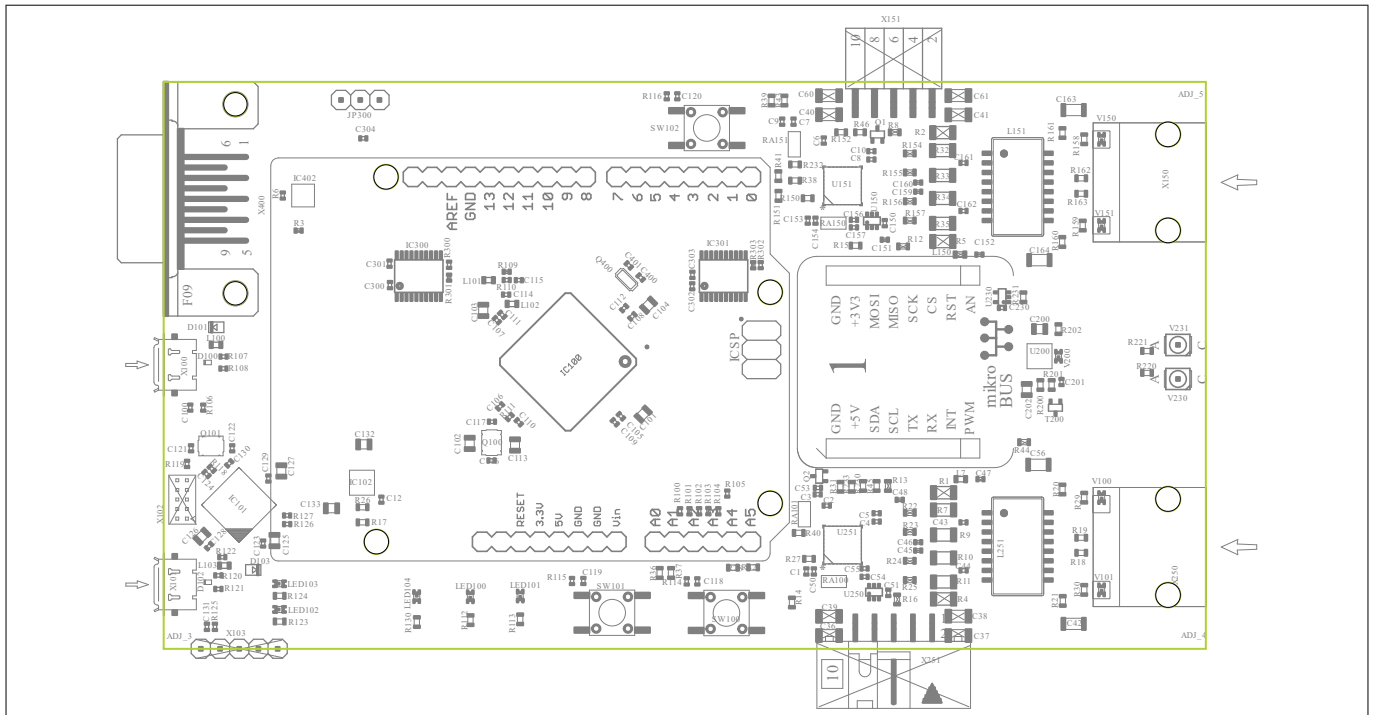

Figure 22 Assembly diagram (see revision Revision 1.2)

3.3 Bill of material

The BOM is valid for the XMC4300 Relax EtherCAT® Kit in hardware version 1.1.

Table 7 List of material

Value	Device	Qty	Reference designator
IFX1051LE TSON8	CAN transceiver Infineon	1	IC402
15pF 50V 10% 0402	Capacitor COG	6	C116, C117, C121, C122, C400, C401
1000pF 2kV 10% 1206	Capacitor X5R	4	C42, C56, C163, C164
10nF 50V 10% 0402	Capacitor X5R	1	C120, C201
4.7uF 10V 10% 0805	Capacitor X5R	1	C125
100 nF 50 V 10% 0402	Capacitor X7R	47	C43, C44, C45, C46, C47, C48, C50, C51, C53, C54, C55, C100, C105, C106, C107, C108, C109, C110, C111, C112, C114, C115, C118, C119, C123, C124, C128, C129, C130, C131, C150, C151, C152, C153, C154, C156, C157, C159, C160, C161, C162, C230, C300, C301, C302, C303, C304
100 nF 50 V 10% 1206	Capacitor X7R	8	C36, C37, C38, C39, C40, C41, C60, C61

(table continues...)

3 Production data
Table 7 (continued) List of material

Value	Device	Qty	Reference designator
10 uF 10 V 10% 0805	Capacitor X7R	15	C49, C52, C101, C102, C103, C104, C113, C126, C127, C132, C133, C155, C158, C200, C202
ARDUINO_UNO_V2	Connection Headers for Arduino UNO	1	PCB1
MIKROE_BUS_CONN	Connection Headers for mikroBus	1	MIKROBUS1
DSUB9-male	Connector D-SUB male 9pol R/A THT	1	X400
ZX62-AB-5PA	Connector Micro USB AB SMD Hirose	2	X100, X101
43860-0010	Connector RJ45 R/A Molex	2	X150, X250
12 MHz 3.2x2.5	Crystal 12 MHz 4Pad NX3225SA 12 MHz NDK	2	Q100, Q101
32.768KHz 3.2x1.5	Crystal 32.768 KHz SMD 12.5pF NDK NX3215SA-32.768K	1	Q400
ESD8V0L2B-03L TSLP-3-1	Diode protection Infineon	2	D100, D102
BAS3010A-03W SOD323	Diode Schottky 30 V 1 A Infineon	2	D101, D103
BCM5241XA1KMLG MLP-32	Ethernet PHY Broadcom	2	U151, U251
PT61017PEL	Ethernet Transformer 1:1 SMD Bourns	2	L151, L251
BLM18PG600SN1D 0603	Ferrite Bead 60R 500mA Murata	6	L7, L100, L101, L102, L103, L150
NC7SZ157P6X	IC 2-Input Multiplexer	2	U150, U250
NC7SZ125	IC Buffer with 3-state output	1	U230
TXS0108EPW TSSOP-20	IC Level Shifter 8-bit	2	IC300, IC301
LED GN 0603	LED green SMD	6	LED102, LED103, LED104, V101, V151, V200
LED GE 0603	LED yellow SMD	2	V100, V150
LED GN P-LCC2	LED green SMD	1	V230
LED RT 0603	LED red SMD	2	LED100, LED101
LED RT P-LCC2	LED red SMD	1	V231
XMC4200-Q48K256 QFN48	Microcontroller XMC4200 Infineon	1	IC101
XMC4300-F100K256 LQFP100	Microcontroller XMC4300 Infineon	1	IC100
no ass. 2x5-pin 0.1" female	Pin Header THT no assembly	1	X151
no ass. 2x5-pin 0.1" male	Pin Header THT no assembly	1	X251
3-pin 0.1"	Pin Header THT	1	JP300
no ass. 2x5pin 0.05"	Pin Header THT FTSH-105-01-F-D-K no assembly	1	X102

(table continues...)

3 Production data**Table 7 (continued) List of material**

Value	Device	Qty	Reference designator
no ass. 5-pin 0.1"	Pin Header THT no assembly	1	X103
FSM2JSMA	Pushbutton ON SMD Tyco	3	SW100, SW101, SW102
0R 0402	Resistor	1	R110
0R 1206	Resistor	8	R7, R9, R10, R11, R32, R33, R34, R35
100R 1% 0402	Resistor	6	R100, R101, R102, R103, R104, R105
10k 1% 0402	Resistor	7	R114, R115, R116, R119, R127, R300, R302
10k 1% 0603	Resistor	3	R201, R230, R231
120R 1% 0402	Resistor	1	R6
1M 10% 0402	Resistor	2	R106, R125
1k24 1% 0603	Resistor	2	R26, R153
1k5 1% 0603	Resistor	2	R202, R233
22R 1% 0402	Resistor	2	R107, R108, R120, R121
270R 1% 0603	Resistor	4	R29, R30, R158, R159
2k2 1% 0603	Resistor	2	R31, R152
49R9 1% 0603	Resistor	12	R22, R23, R24, R25, R27, R28, R150, R151, R154, R155, R156, R157
4k7 1% 0402	Resistor	1	R126
4k7 1% 0603	Resistor	1	R232
4k87 1% 0603	Resistor	1	R200
510R 1% 0402	Resistor	3	R111, R118, R122
680R 1% 0603	Resistor	7	R112, R113, R123, R124, R130, R220, R221
75R 1/ 0603	Resistor	8	R18, R19, R20, R21, R160, R161, R162, R163
no ass. 0R 0402	Resistor	1	R3
no ass. 0R 0402	Resistor	1	R303
no ass. 0R 0402	Resistor	2	R109, R301
no ass. 0R 1206	Resistor	4	R1, R2, R4, R5
4*49R9 1% ARRAY4_0.8	Resistor Array	4	RA100, RA101, RA150, RA151
BCR108W SOT323	Transistor NPN Infineon	1	T200
IFX1117MEV33 SOT223	Voltage regulator 3.3 V Infineon	1	IC102
IFX54441LDV TSON-10	Voltage regulator adj. Infineon	1	U200

Revision history

Revision history

Major changes since the last revision

Page or reference	Description of change
Revision 1.1 2022-06-10	The XMC™ EtherCAT® Phy Board has been redesigned due to replacement of the BCM5241XA1KMLG PHY through the DP83848VYB/NOPBVXH48A-M PHY The redesigned PCB has got a new marking: XMC4300 Relax EtherCAT Kit-V3
Revision 1.2 2022-06-20	The XMC™ EtherCAT® Phy Board has been redesigned due to replacement of the BCM5241XA1KMLG PHY through the ADIN1200 PHY The redesigned PCB has got a new marking: XMC4300 Relax EtherCAT Kit-V2.1

Trademarks

All referenced product or service names and trademarks are the property of their respective owners.

Edition 2022-06-20

Published by

Infineon Technologies AG

81726 Munich, Germany

© 2022 Infineon Technologies AG

All Rights Reserved.

Do you have a question about any aspect of this document?

Email: erratum@infineon.com

Document reference

IFX-lcg1646997135385

Important notice

The information given in this document shall in no event be regarded as a guarantee of conditions or characteristics ("Beschaffheitsgarantie").

With respect to any examples, hints or any typical values stated herein and/or any information regarding the application of the product, Infineon Technologies hereby disclaims any and all warranties and liabilities of any kind, including without limitation warranties of non-infringement of intellectual property rights of any third party.

In addition, any information given in this document is subject to customer's compliance with its obligations stated in this document and any applicable legal requirements, norms and standards concerning customer's products and any use of the product of Infineon Technologies in customer's applications.

The data contained in this document is exclusively intended for technically trained staff. It is the responsibility of customer's technical departments to evaluate the suitability of the product for the intended application and the completeness of the product information given in this document with respect to such application.

Warnings

Due to technical requirements products may contain dangerous substances. For information on the types in question please contact your nearest Infineon Technologies office.

Except as otherwise explicitly approved by Infineon Technologies in a written document signed by authorized representatives of Infineon Technologies, Infineon Technologies' products may not be used in any applications where a failure of the product or any consequences of the use thereof can reasonably be expected to result in personal injury.