

Series

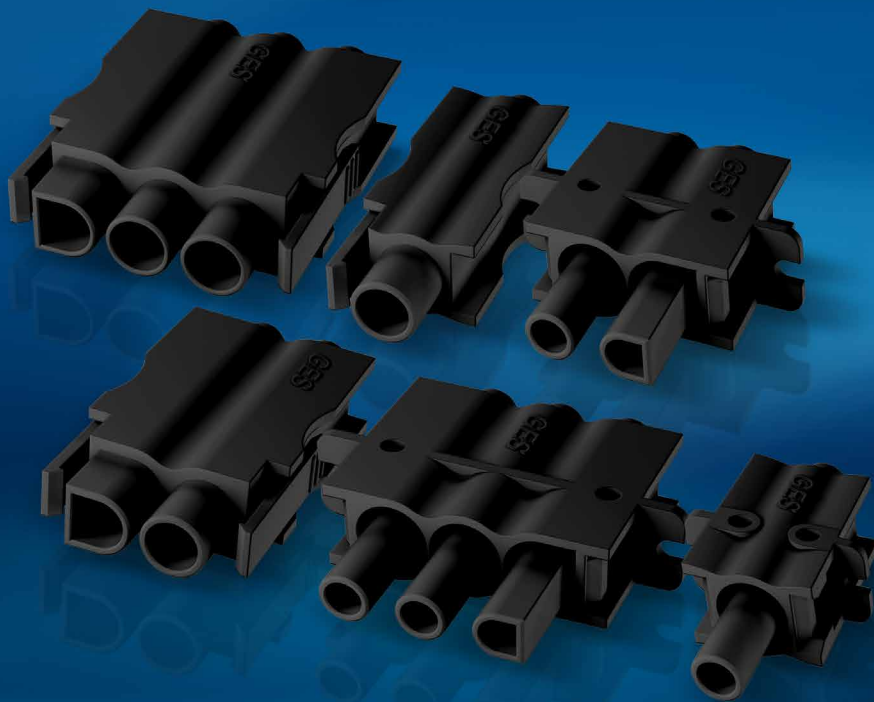

MOD Series M Series MC Series MCS Series VP Series 100 Series S Series

- Operating voltages up to 13 kVDC
- Operating current 13 Amps / 30 Amps
- Ideal for internal cabling
- Quick assembly
- Several mounting options offering enhanced flexibility

General characteristics and technical data Series VarioPro CL

Electrical values	
Operating voltage (DC)	13 kV
Test voltage (DC)	20 kV

Housing	
Number of HV contacts	1 - 3
Insulation material	PBT
Flammability class	UL94 V-0
Operating temperature	-40°C to +150°C
Insulating material group	I (DIN IEC 60664)

Contacts 1.6 mm	
Termination method	crimp
Rated current	13 A
Contact resistance	≤ 5 mΩ
Contact diameter	1.6 mm [.063"]
Wire size (AWG / cross section)	AWG 26 - 14 (0.14 - 2.5 mm ²)
Contact material	brass (CuZn)
Contact plating	silver (Ag), gold (Au)
Mating cycles	≥ 1,000
Rated temperature	+120°C

Suitable cable dimensions

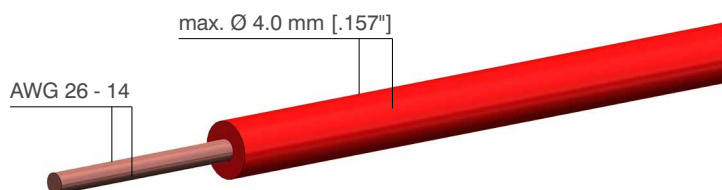

VarioPro CL1 - receptacle

Drawing

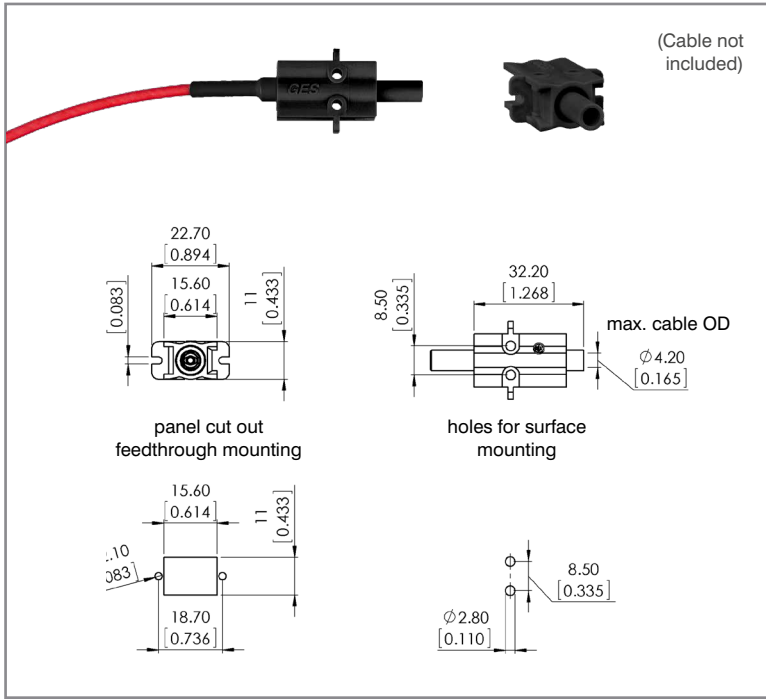

VarioPro CL1 - plug

Drawing

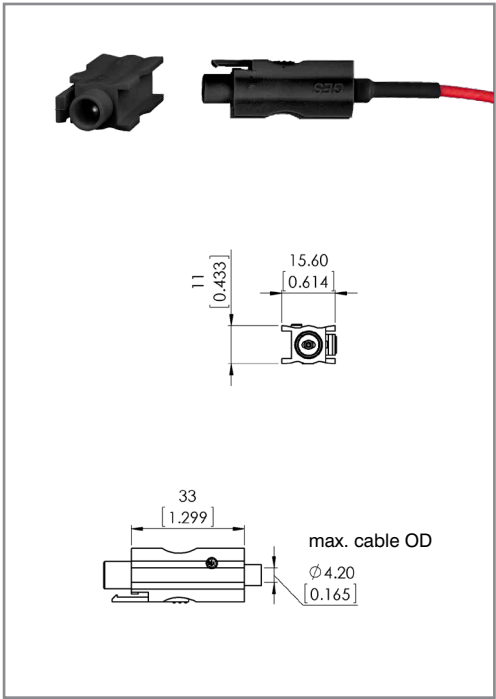

drawing - dimensions in mm [inch]

P/N	Description	Plug male contact	Receptacle female contact	Number of contacts	Including contacts	Contacts silver plated	Contacts gold plated
5000440	VP-CL-1HV-BU AWG 26 - 22 Ag		•	1	•	•	
5000441	VP-CL-1HV-BU AWG 20 Ag		•	1	•	•	
5000442	VP-CL-1HV-BU AWG 20 - 16 Ag		•	1	•	•	
5000443	VP-CL-1HV-BU AWG 16 - 15 Ag		•	1	•	•	
5000444	VP-CL-1HV-BU AWG 14 Ag		•	1	•	•	
5000445	VP-CL-1HV-BU AWG 26 - 22 Au		•	1	•		•
5000446	VP-CL-1HV-BU AWG 20 Au		•	1	•		•
5000447	VP-CL-1HV-BU AWG 20 - 16 Au		•	1	•		•
5000448	VP-CL-1HV-BU AWG 16 - 15 Au		•	1	•		•
5000449	VP-CL-1HV-BU AWG 14 Au		•	1	•		•
5000450	VP-CL-1HV-ST AWG 26 - 22 Ag	•		1	•	•	
5000451	VP-CL-1HV-ST AWG 20 Ag	•		1	•	•	
5000452	VP-CL-1HV-ST AWG 20 - 16 Ag	•		1	•	•	
5000453	VP-CL-1HV-ST AWG 16 - 15 Ag	•		1	•	•	
5000454	VP-CL-1HV-ST AWG 14 Ag	•		1	•	•	
5000455	VP-CL-1HV-ST AWG 26 - 22 Au	•		1	•		•
5000456	VP-CL-1HV-ST AWG 20 Au	•		1	•		•
5000457	VP-CL-1HV-ST AWG 20 - 16 Au	•		1	•		•
5000458	VP-CL-1HV-ST AWG 16 - 15 Au	•		1	•		•
5000459	VP-CL-1HV-ST AWG 14 Au	•		1	•		•

➔ For cables and tools - please see page 69

Assembly Instructions Series VP ClipLock - plug

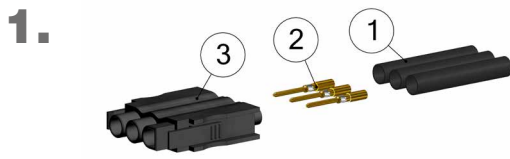

1.

Part as supplied
Shrinking tube (1), male contact (2),
connector shell (3)

5.



Slide contact (2) completely into connector shell (3) until contact snaps
☞ Pull gently to check that contact is correctly located and remains in position

2.

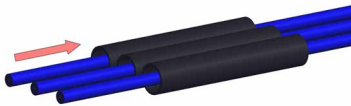

Place shrinking tube (1) on cable

6.

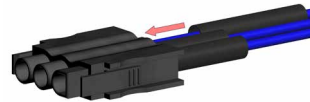

Slide shrinking tube (1) on connector shell (3)

3.



Remove dielectric insulation (L1 = 5-8 mm)

7.



Shrink tube - shrinking temperature 110°C

4.

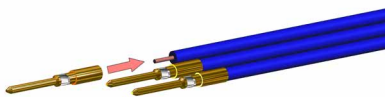

Solder or crimp contact (2) on conductor
⚠ Please notice for soldering: Tin-solder must not remain on contact surface

8.



Assembly finished



Note – important!

1. Please carefully read assembly instructions before cable assembly.

2. Cable assembly must only be done by trained and qualified personnel.

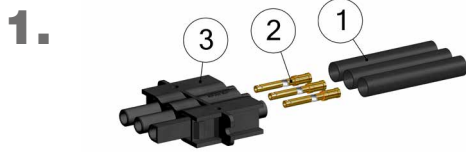

Part as supplied
Shrinking tube (1), female contact (2), connector shell (3)

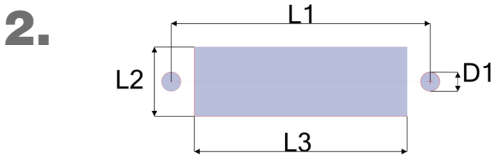

Panel cut out – feedthrough mounting

Type	D1 mm [inch]	L1 mm [inch]	L2 mm [inch]	L3 mm [inch]
VP-CL-1HV-BU	2.10 [.083"]	18.70 [.736"]	11.20 [.441"]	15.80 [.622"]
VP-CL-2HV-BU	3.10 [.122"]	33.00 [1.299"]	11.20 [.441"]	25.50 [1.004"]
VP-CL-3HV-BU	3.10 [.122"]	42.00 [1.654"]	11.20 [.441"]	34.50 [1.358"]



Panel cut out – surface mounting

Type	D2 mm [inch]	L4 mm [inch]
VP-CL-1HV-BU	2.80 [.110"]	8.50 [.335"]
VP-CL-2HV-BU	2.80 [.110"]	17.50 [.689"]
VP-CL-3HV-BU	2.80 [.110"]	26.50 [1.043"]

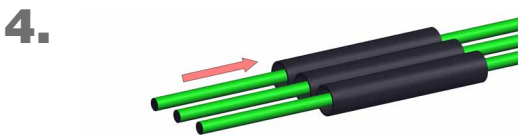

Place shrinking tube (1) on cable

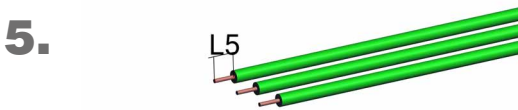

Remove dielectric insulation
(L5 = 5-8 mm [.197" - .315"])



Solder or crimp contact (2) on conductor

⚠ Please notice for soldering: Tin-solder must not remain on contact surface



Slide contact (2) completely into connector shell (3) until contact snaps

🗨 Pull gently to check that contact is correctly located and remains in position

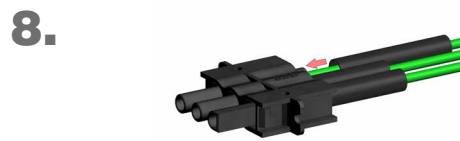

Slide shrinking tube (1) on connector shell (3)



Shrink tubes - shrinking temperature 110°C



Assembly finished



Note – important!

1. Please carefully read assembly instructions before cable assembly.

2. Cable assembly must only be done by trained and qualified personnel.