



Power Inductor ADHE Series

Automotive
AEC-Q200

RoHS Compliant
Halogen Free
REACH Compliant



- Power Circuit
- Shield
- Wire Wound
- Metal
- Ultra High Current

Part Numbering

A	DHE	00	252012	1R0	M	Q1
Grade	Series Name	Control Code	Dimensions Code (mm)	Inductance (uH)	Tolerance	Internal Code
			252012 2.5x2.0x1.2	R33 0.33 R68 0.68 1R0 1.0	M ±20%	

Power Inductor ADHE Series

**Automotive
AEC-Q200**

ADHE00252012 Type

■ Dimensions

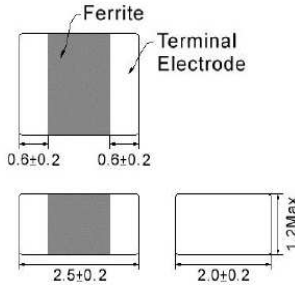

unit:mm

■ Recommended Land Pattern

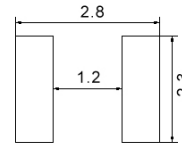

unit:mm

■ Electrical Characteristics

Part No.	Inductance (uH)	Test Freq.	RDC(mΩ) Max(Typ)	Isat(A) Max(Typ)	Irms(A) Max(Typ)	Tolerance (±%)
ADHE00252012R33MQ1	0.33	2MHz,0.2V	22(16)	6.2(7.0)	4.7(5.4)	20
ADHE00252012R47MQ1	0.47	2MHz,0.2V	33(28)	5.2(6.1)	4.0(4.7)	20
ADHE00252012R68MQ1	0.68	2MHz,0.2V	36(30)	4.5(5.2)	3.5(4.1)	20
ADHE002520121R0MQ1	1	2MHz,0.2V	42(35)	3.7(4.3)	3.3(3.8)	20
ADHE002520121R5MQ1	1.5	2MHz,0.2V	62(52)	3.3(3.9)	2.3(2.7)	20
ADHE002520122R2MQ1	2.2	2MHz,0.2V	87(74)	2.9(3.4)	2.2(2.6)	20

Note: When ordering, please specify tolerance code. Tolerance: M=±20%

1. Operating temperature range - 40°C ~ 125°C (Including self - temperature rise)
2. Isat for Inductance drop 30% from its value without current
3. Irms for a 40°C temprature rise from 25°C ambient with current
4. Absolute maximum voltage 20VDC
5. Measure Equipment:
 - L: Agilent E4991/HP4286A+16197A (or equivalent), 2MHz 0.2V
 - RDC: CHEN HWA502BC/HP4338B (or equivalent)
 - Isat: Agilent E4980A+HP42841A (or equivalent)
 - Irms: Agilent 6641 SYSTEM DC POWER SUPPLY (or equivalent)

Power Inductor ADHE Series

**Automotive
AEC-Q200**

ADHE00252012 Type

Characteristics Graph

Inductance vs. DC Current

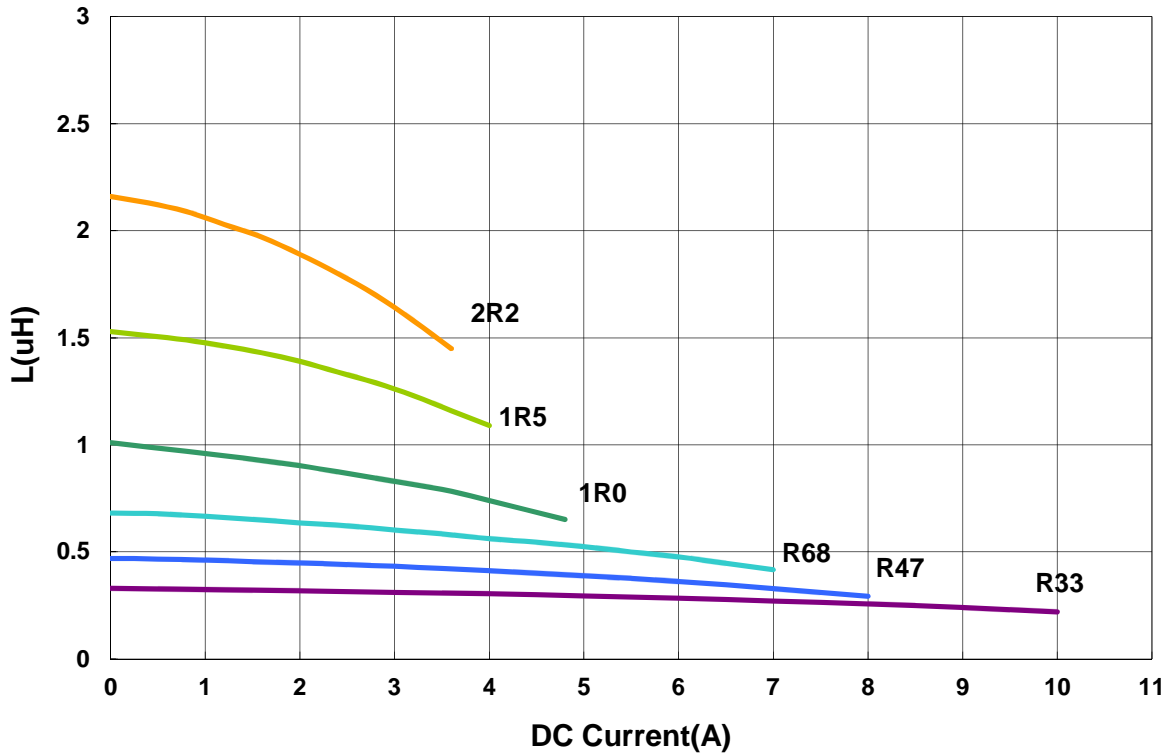

Temperature Change vs. DC Current

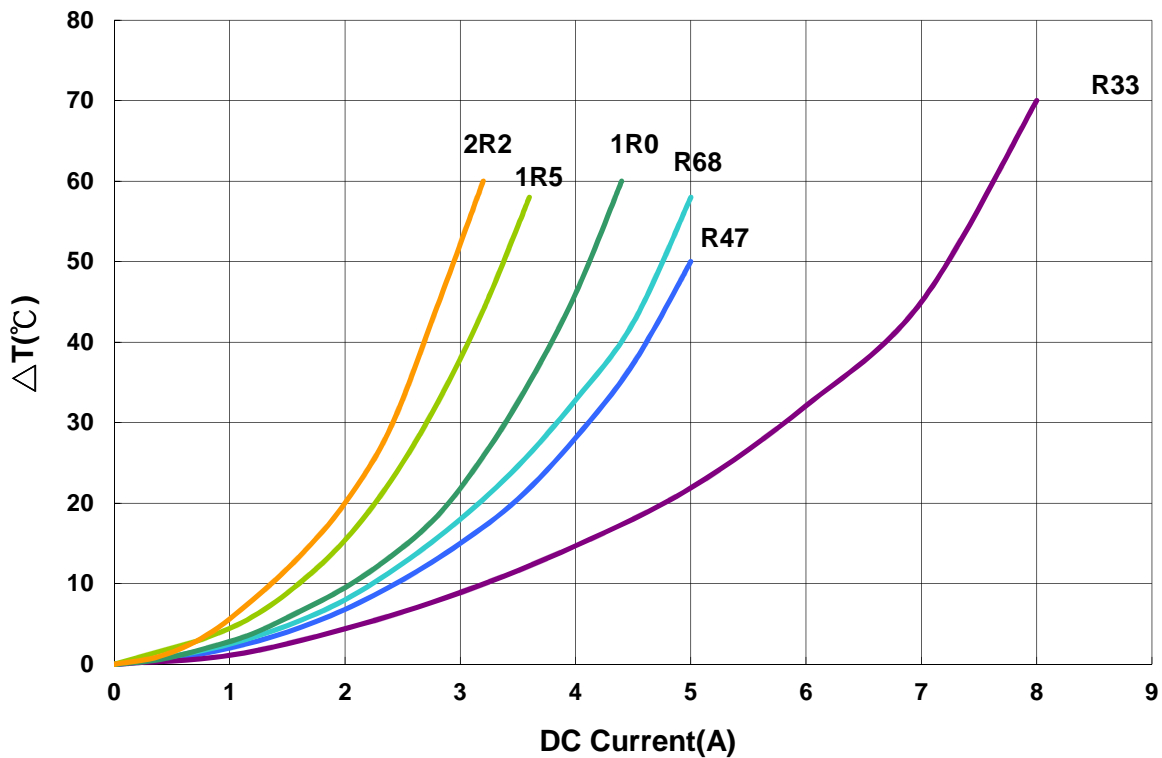

Power Inductor ADHE Series

**Automotive
AEC-Q200**

■ Packaging

Tape Dimensions

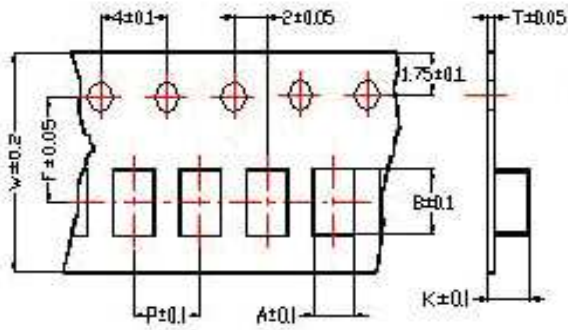

Tape Material

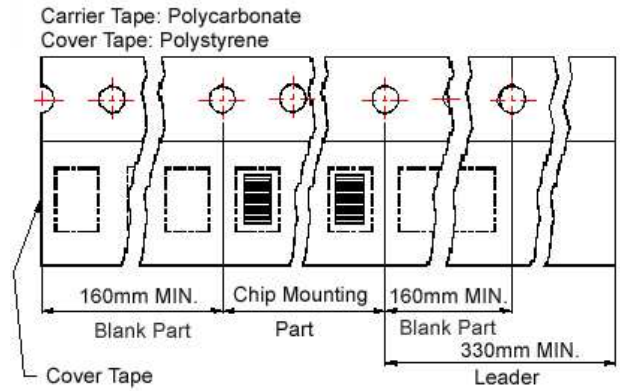

Reel Dimensions

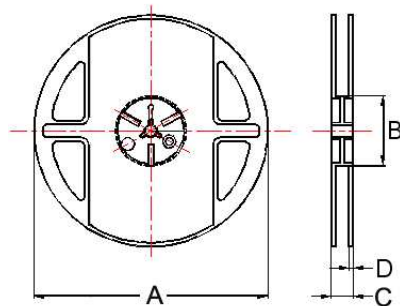

Dimensions in mm

TYPE	Tape Dimensions							Reel Dimensions				Quantity PCS / Reel
	A	B	T	W	P	F	K	A	B	C	D	
ADHE00252012	2.30	2.80	0.22	8	4	3.5	1.35	178	60	12	2	3000