

LM4962 Boomer® Audio Power Amplifier Series Ceramic Speaker Driver

Check for Samples: [LM4962](#)

FEATURES

- Click and Pop Circuitry Eliminates Noise During Turn-On and Turn-Off Transitions
- Low Current Shutdown Mode
- Low Quiescent Current
- Mono 15Vp-p BTL Output, $R_L = 2\mu\text{F} + 9.4\Omega$, $f = 1\text{kHz}$, 1% THD+N
- Over-Current Protection
- Over-Voltage Protection
- Unity-Gain Stable
- External Gain Configuration Capability
- Including Band Switch Function
- Leakage Cut Switch (SW-LEAK)
- Soft-Start Function
- Space-Saving DSBGA Package (2mm x 2.5mm)

APPLICATIONS

- Smart Phones
- Mobile Phones and Multimedia Terminals
- PDA's, Internet Appliances, and Portable Gaming
- Portable DVD
- Digital Still Cameras/Camcorders

KEY SPECIFICATIONS

- Quiescent Power Supply Current (Boost Converter + Amplifier): 9 mA (typ)
- Voltage Swing in BTL at 1% THD, $f = 1\text{kHz}$: 15 Vp-p (typ)
- Shutdown Current: 0.1 μA (typ)
- OVP: $8.5\text{V} < V_{\text{AMP}} < 9.5\text{V}$

DESCRIPTION

The LM4962 is an audio power amplifier primarily designed for driving Ceramic Speaker for applications in Cell Phones, Smart Phones, PDA's and other portable applications. It is capable of driving 15Vpp (typ) BTL with less than 1% THD+N from a $3.2V_{\text{DC}}$ power supply. The LM4962 features and low power consumption shutdown mode, an internal thermal shutdown protection mechanism, along with over current protection (OCP) and over voltage protection (OVP).

Boomer audio power amplifiers were designed specifically to provide high quality output power with a minimal number of external components. The LM4962 does not require bootstrap capacitors, or snubber circuits.

The LM4962 also features a Band-Switch function which allows the user to use one amplifier device for both receiver (earpiece) mode and ringer/loudspeaker mode.

The LM4962 contains advanced click and pop circuitry that eliminates noises which would otherwise occur during turn-on and turn-off transitions. Additionally, the internal boost converter features a soft-start function.

The LM4962 is unity-gain stable and can be configured by external gain-setting resistors.



Please be aware that an important notice concerning availability, standard warranty, and use in critical applications of Texas Instruments semiconductor products and disclaimers thereto appears at the end of this data sheet.

All trademarks are the property of their respective owners.

Connection Diagram

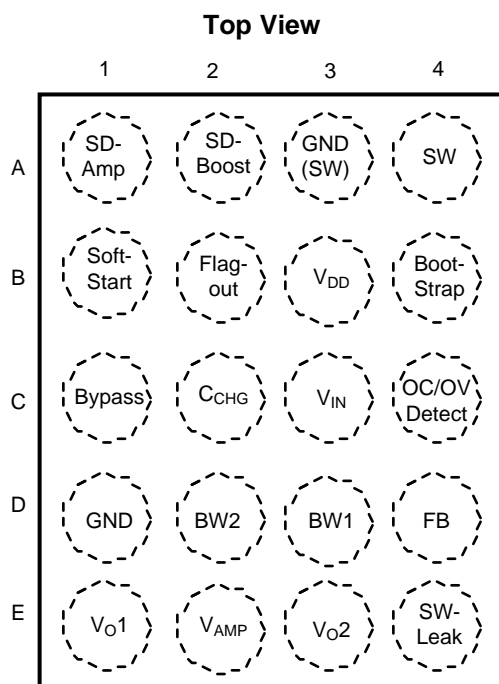

Figure 1. DSBGA Package
See Package Number YZR002011A

Typical Application

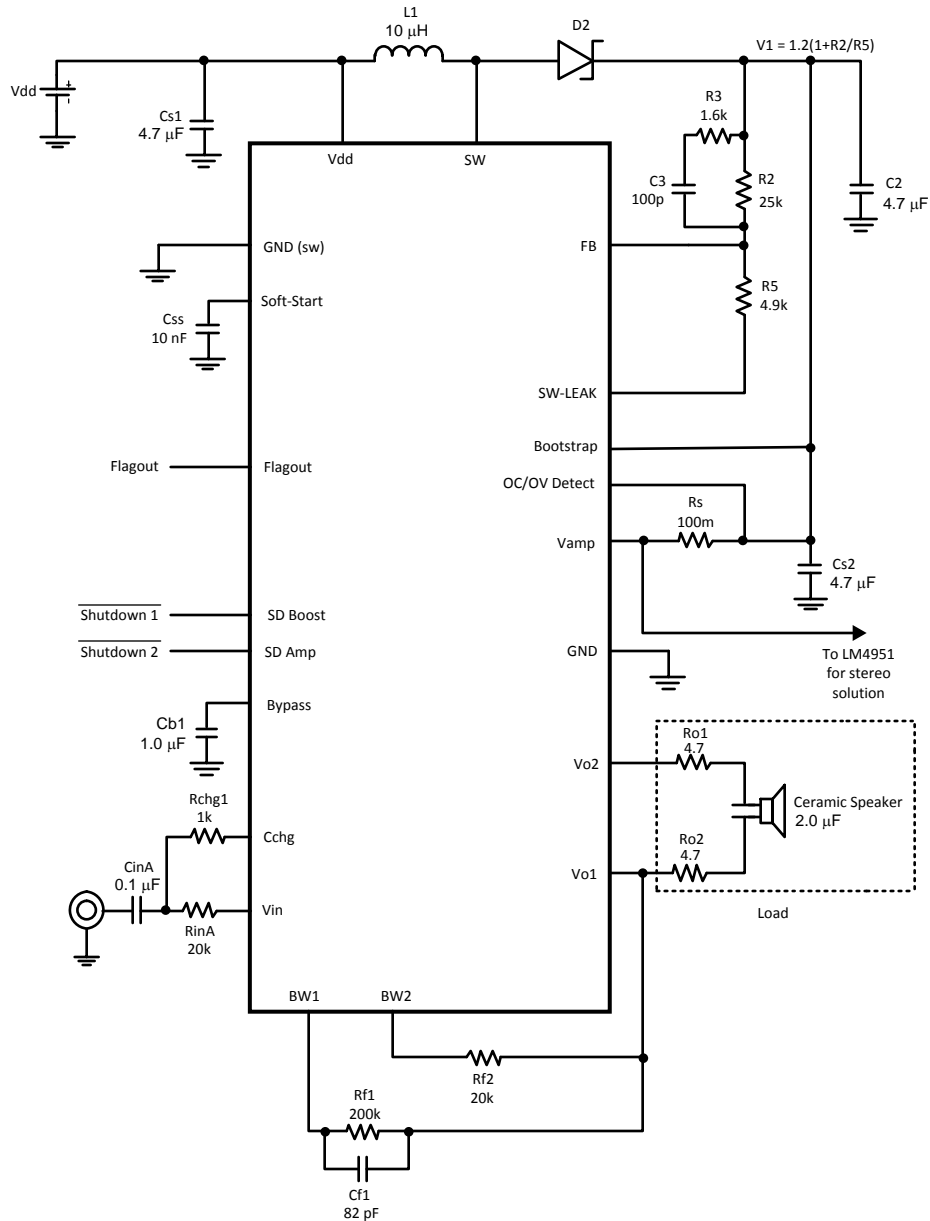

Figure 2. Typical Audio Amplifier Application Circuit

Block Diagram

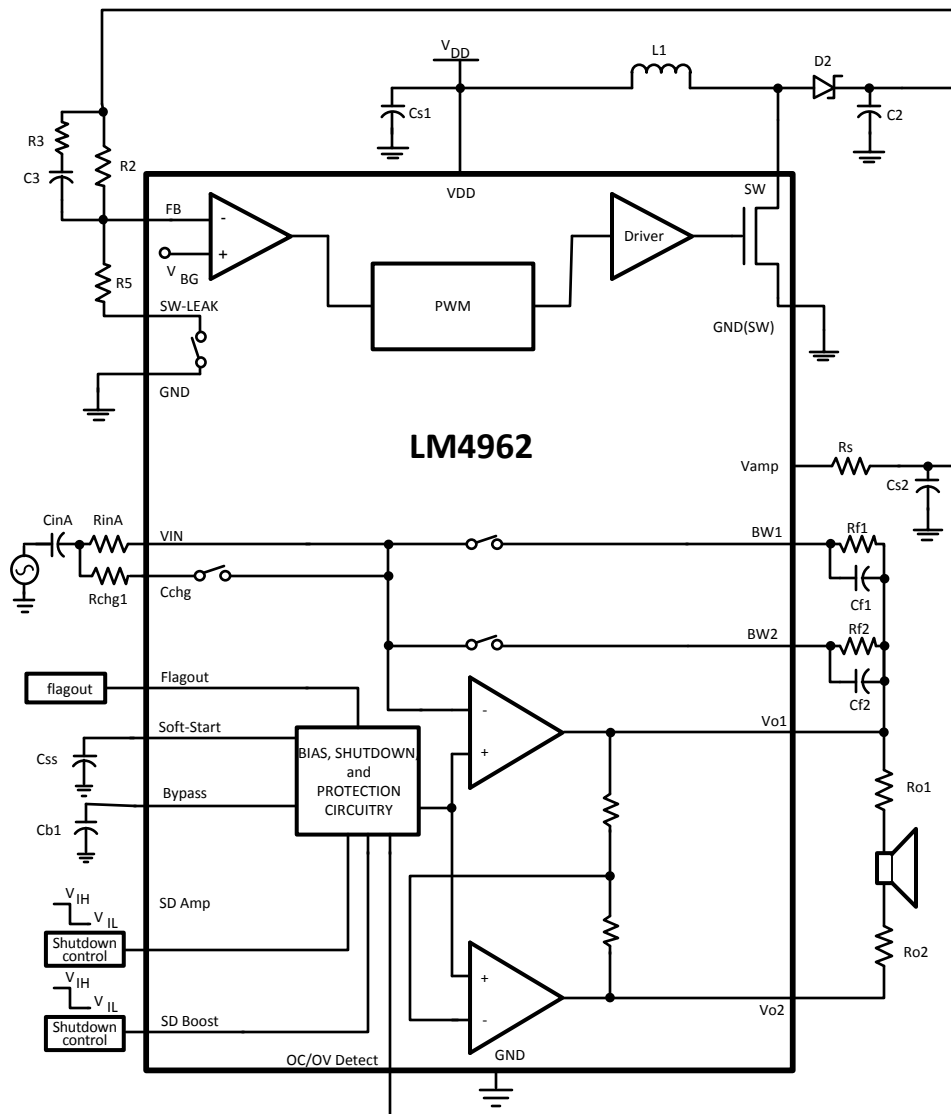

Figure 3. LM4962 Block Diagram



These devices have limited built-in ESD protection. The leads should be shorted together or the device placed in conductive foam during storage or handling to prevent electrostatic damage to the MOS gates.

Absolute Maximum Ratings^{(1) (2)(3)}

Supply Voltage (V_{DD})		9.5V
Amplifier Supply Voltage (V_{AMP})		9.5V
Storage Temperature		-65°C to +150°C
Input Voltage		-0.3V to $V_{DD} + 0.3V$
Power Dissipation ⁽⁴⁾		Internally limited
ESD Susceptibility ⁽⁵⁾		2000V
ESD Susceptibility ⁽⁶⁾		200V
Junction Temperature		150°C
Thermal Resistance	θ_{JA} (DSBGA) ⁽⁷⁾	73°C/W

- (1) All voltages are measured with respect to the GND pin, unless otherwise specified.
- (2) Absolute Maximum Ratings indicate limits beyond which damage to the device may occur. Operating Ratings indicate conditions for which the device is functional, but do not ensure specific performance limits. Electrical Characteristics state DC and AC electrical specifications under particular test conditions which ensure specific performance limits. This assumes that the device is within the Operating Ratings. Specifications are not ensured for parameters where no limit is given, however, the typical value is a good indication of device performance.
- (3) If Military/Aerospace specified devices are required, please contact the Texas Instruments Sales Office/ Distributors for availability and specifications.
- (4) The maximum power dissipation must be derated at elevated temperatures and is dictated by T_{JMAX} , θ_{JA} , and the ambient temperature, T_A . The maximum allowable power dissipation is $P_{DMAX} = (T_{JMAX} - T_A) / \theta_{JA}$ or the given in Absolute Maximum Ratings, whichever is lower.
- (5) Human body model, 100pF discharged through a 1.5k Ω resistor.
- (6) Machine Model, 220pF–240pF discharged through all pins.
- (7) The value for a θ_{JA} is measured with the LM4962 mounted on a 3" x 1.5" 4 layer board. The copper thickness for all 4 layers is 0.5oz (roughly 0.18mm).

Operating Ratings

Temperature Range ($T_{MIN} \leq T_A \leq T_{MAX}$) ⁽¹⁾		-40°C $\leq T_A \leq$ +85°C
Supply Voltage (V_{DD})		3.0V < V_{DD} < 5.0V
Amplifier Supply Voltage (V_I) ⁽²⁾		2.7V < V_{AMP} < 9.0V

- (1) Temperature range is tentative, pending characterization.
- (2) An amplifier supply voltage of 9.0V can only be obtained when the over current and over voltage protection circuitry is disabled (OV/OC Detect pin is disabled).

Electrical Characteristics

The following specifications apply for $V_{DD} = 3.2V$, $A_{V-BTL} = 26dB$, $Z_L = 2\mu F + 9.4\Omega$, $C_b = 1.0\mu F$, $R_2 = 25K\Omega$, $R_5 = 4.9K\Omega$ unless otherwise specified. Limits apply for $T_A = 25^\circ C$.

Parameter		Test Conditions	LM4962		Units (Limits)
			Typ ⁽¹⁾	Limit ⁽²⁾⁽³⁾	
I_{DD}	Quiescent Power Supply Current in Boosted Ringer Mode	$V_{IN} = 0V$,	9	12	mA (max)
I_{ddrcv}	Quiescent Power Supply Current in Receiver Mode	SD Boost = GND SD Amp = V_{DD}	3	5	mA (max)
I_{SD}	Shutdown Current ⁽⁴⁾	SD Boost = SD Amp = GND	0.1	2.0	μA (max)
V_{LH}	Logic High Threshold Voltage	For SD Boost, SD Amp		1.2	V (min)
V_{LL}	Logic Low Threshold Voltage	For SD Boost, SD Amp		0.4	V (max)
$R_{PULLDOWN}$	Pulldown Resistor	For SD Amp, SD Boost	80	60	k Ω (min)
T_{WUBC}	Boost Converter Wake-up Time	$C_{SS} = 10nF$	2	5	ms (max)
T_{WUA}	Audio Amplifier Wake-up Time	(For $V_{dd} = 2.7V$ to $8.5V$)	20	40	msec
V_{OUT}	Output Voltage Swing	THD = 1% (max), $f = 1kHz$	15	14	V_{pp} (min)
THD+N	Total Harmonic Distortion + Noise	$V_{out} = 14V_{pp}$, $f = 1kHz$	0.4	1.0	%
ϵ_{OS}	Output Noise	A-Weighted Filter, $V_{IN} = 0V$	125		μV
PSRR	Power Supply Rejection Ratio	$V_{RIPPLE} = 200mV_{p-p}$, $f = 100Hz$, Input Referred	86	71	dB (min)
$R_{on-sw-leak}$	On Resistance on SW-Leak	SD Boost = GND $I_{sink} = 100\mu A$	30	50	Ω (max)
R_{on}	Flagout On resistance	$I_{sink} = 1mA$	50	100	Ω (max)
V_{ovp}	Sensitivity of Over Voltage Protection on V_{AMP}	Flagout = GND	9.0	9.5 8.5	V (max) V (min)
V_{ocp}	Sensitivity of Over Current Protection (Voltage Across R_S)	Flagout = GND	185	275 75	mV (max) mV (min)
I_{leak}	Leak Current on Flagout pin	$V_{flagout} = V_{DD}$		2	μA (max)
I_{SW}	SW Current Limit		2	2.7 1.2	A (max) A (min)
TSD	Thermal Shutdown Temperature			150	$^\circ C$ (min)
V_{os}	Output Offset Voltage		5	25	mV
V_{FB}	Feedback Voltage	SD Boost = V_{DD} SD Amp = V_{DD}	1.23	1.15 1.31	V (min) V (max)

(1) Typicals are measured at $25^\circ C$ and represent the parametric norm.

(2) Limits are specified to AOQL (Average Outgoing Quality Level).

(3) Datasheet min/max specification limits are specified by design, test, or statistical analysis.

(4) Shutdown current is measured in a normal room environment. The Shutdown pin should be driven as close as possible to V_{in} for minimum shutdown current.

Typical Performance Characteristics

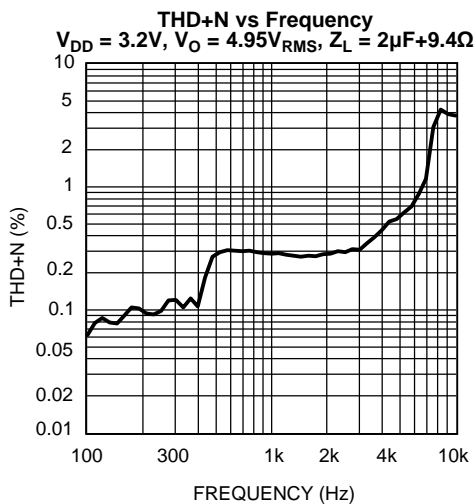

Figure 4.

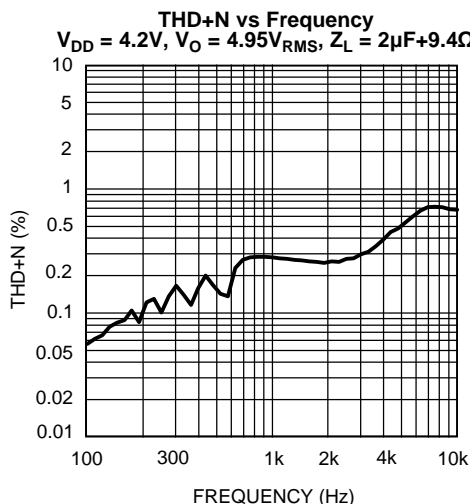

Figure 5.

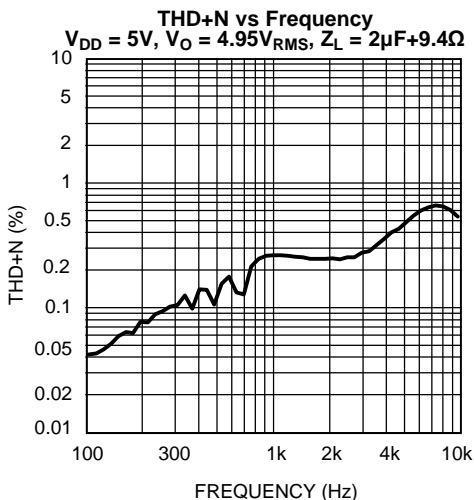

Figure 6.

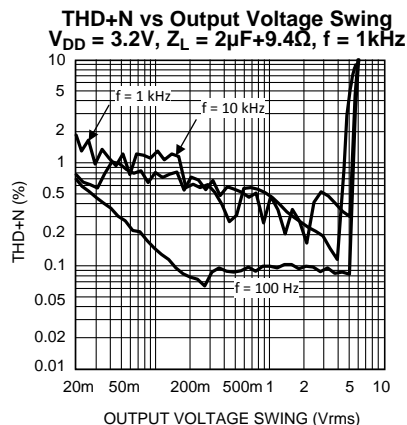

Figure 7.

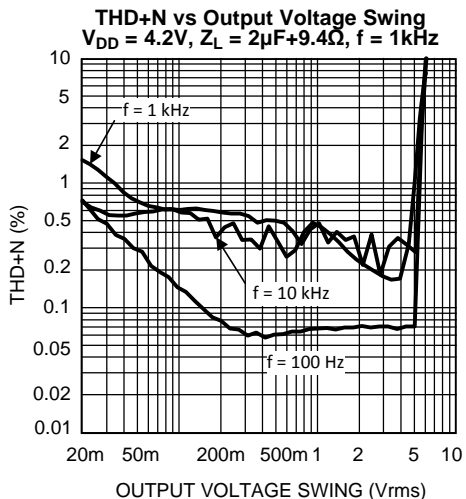

Figure 8.

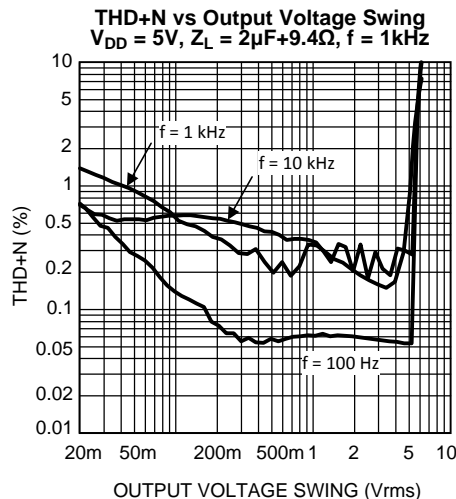

Figure 9.

Typical Performance Characteristics (continued)

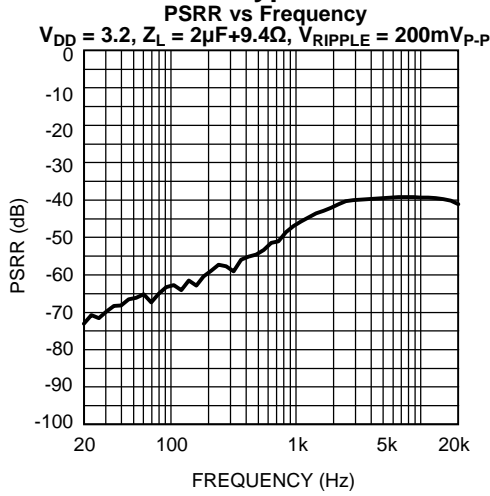

Figure 10.

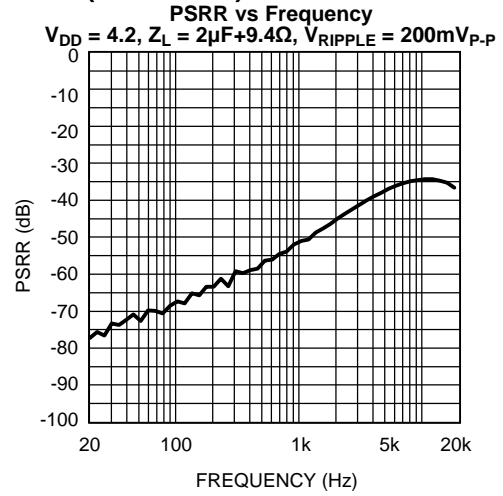

Figure 11.

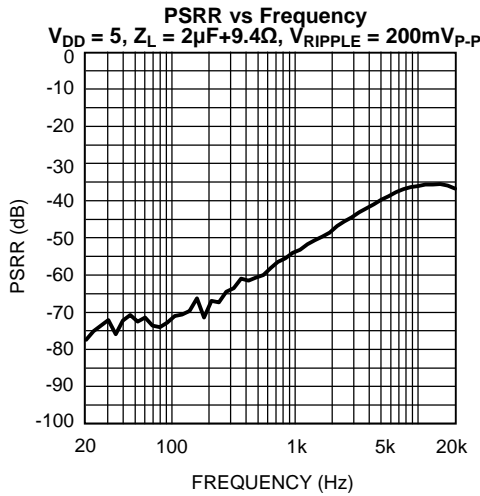

Figure 12.

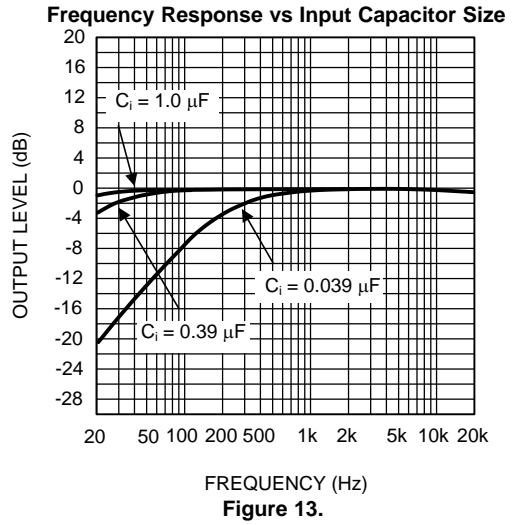

Figure 13.

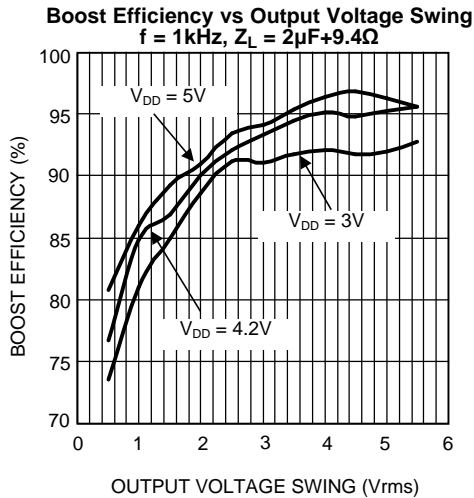

Figure 14.

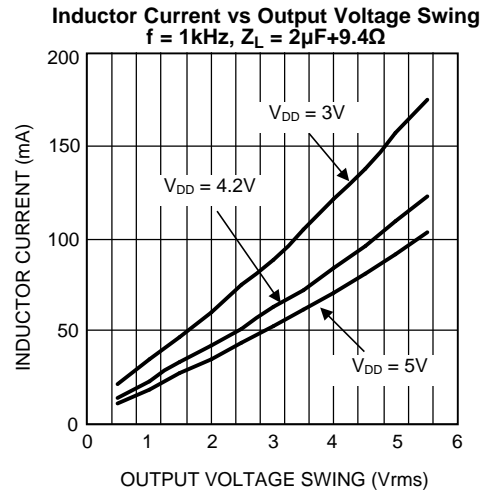

Figure 15.

Typical Performance Characteristics (continued)

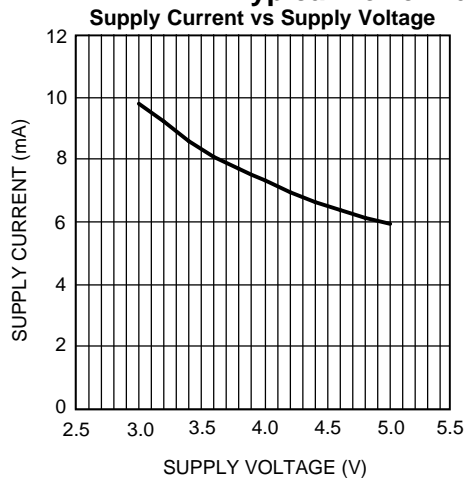

Figure 16.

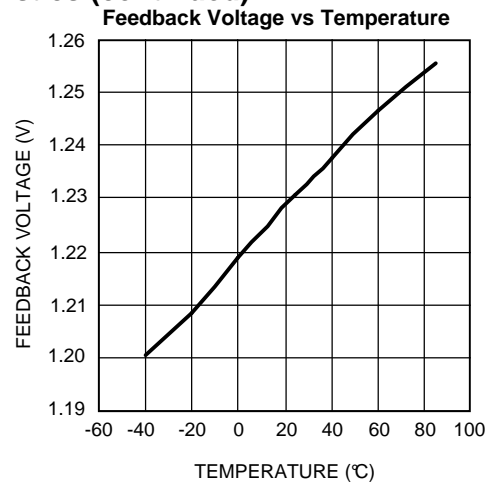

Figure 17.

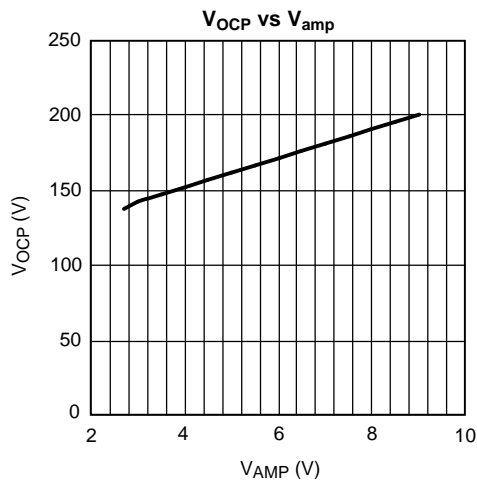

Figure 18.

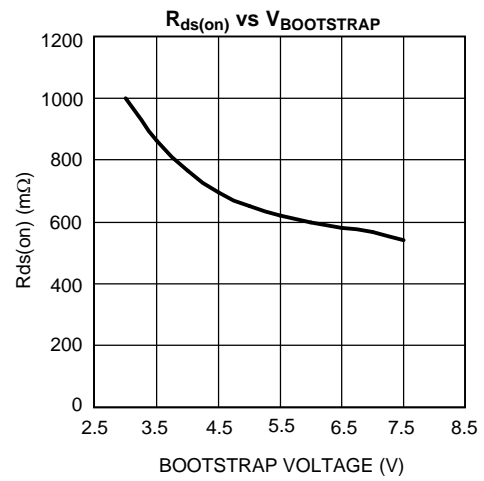

Figure 19.

APPLICATION INFORMATION

BRIDGE CONFIGURATION EXPLANATION

The Audio Amplifier portion of the LM4962 has two internal amplifiers allowing different amplifier configurations. The first amplifier's gain is externally configurable, whereas the second amplifier is internally fixed in a unity-gain, inverting configuration. The closed-loop gain of the first amplifier is set by selecting the ratio of Rf to Ri while the second amplifier's gain is fixed by the two internal 20kΩ resistors. [Figure 2](#) shows that the output of amplifier one serves as the input to amplifier two. This results in both amplifiers producing signals identical in magnitude, but out of phase by 180°. Consequently, the differential gain for the Audio Amplifier is

$$A_{VD} = 2 * (R_f/R_i) \quad (1)$$

By driving the load differentially through outputs Vo1 and Vo2, an amplifier configuration commonly referred to as "bridged mode" is established. Bridged mode operation is different from the classic single-ended amplifier configuration where one side of the load is connected to ground.

A bridge amplifier design has a few distinct advantages over the single-ended configuration. It provides differential drive to the load, thus doubling the output swing for a specified supply voltage.

BOOST CONVERTER POWER DISSIPATION

At higher duty cycles, the increased ON-time of the switch FET means the maximum output current will be determined by power dissipation within the LM4962 FET switch. The switch power dissipation from ON-time conduction is calculated by [Equation \(2\)](#).

$$P_{D(SWITCH)} = DC \times I_{IND(AVE)}^2 \times R_{DS(ON)} \quad (2)$$

where:

DC is the duty cycle.

There will be some switching losses as well, so some derating needs to be applied when calculating IC power dissipation.

MAXIMUM AMPLIFIER POWER DISSIPATION

Power dissipation is a major concern when designing a successful amplifier, whether the amplifier is bridged or single-ended. A direct consequence of the increased power delivered to the load by a bridge amplifier is an increase in internal power dissipation. Since the amplifier portion of the LM4962 has two operational amplifiers, the maximum internal power dissipation is 4 times that of a single-ended amplifier. The maximum power dissipation for a given BTL application can be derived from [Equation \(3\)](#).

$$P_{DMAX(AMP)} = (2V_{DD}^2) / (\pi^2 R_L) \quad (3)$$

where:

$$R_L = R_{o1} + R_{o2}$$

MAXIMUM TOTAL POWER DISSIPATION

The total power dissipation for the LM4962 can be calculated by adding [Equation \(2\)](#) and [Equation \(3\)](#) together to establish [Equation \(4\)](#):

$$P_{DMAX(TOTAL)} = (2V_{DD}^2) / (\pi^2 EFF^2 R_L) \quad (4)$$

where:

EFF = Efficiency of boost converter

$$R_L = R_{o1} + R_{o2}$$

The result from [Equation \(4\)](#) must not be greater than the power dissipation that results from [Equation \(5\)](#):

$$P_{DMAX} = (T_{JMAX} - T_A) / \theta_{JA} \quad (5)$$

For the LQA28A, $\theta_{JA} = 73^{\circ}\text{C/W}$. $T_{JMAX} = 125^{\circ}\text{C}$ for the LM4962. Depending on the ambient temperature, T_A , of the system surroundings, [Equation \(5\)](#) can be used to find the maximum internal power dissipation supported by the IC packaging. If the result of [Equation \(4\)](#) is greater than that of [Equation \(5\)](#), then either the supply voltage must be increased, the load impedance increased or T_A reduced. For typical applications, power dissipation is not an issue. Power dissipation is a function of output power and thus, if typical operation is not around the maximum power dissipation point, the ambient temperature may be increased accordingly.

START-UP SEQUENCE

For the LM4962 correct start-up sequencing is important for optimal device performance. Using the correct start up sequence will improve click/pop performance as well as avoid transients that could reduce battery life. For ringer/loudspeaker mode, the supply voltage should be applied first and both the boost converter and the amplifier should be in shutdown. The boost converter can then be activated followed by the amplifier (see timing diagram, [Figure 20](#)). If the boost converter shutdown is toggled while the amplifier is active a very audible pop will be heard.

SHUTDOWN FUNCTION

In many applications, a microcontroller or microprocessor output is used to control the shutdown circuitry to provide a quick, smooth transition into shutdown. Another solution is to use a single-pole, single-throw switch connected between V_{DD} and Shutdown pins.

BAND SWITCH FUNCTION

The LM4962 features a Band Switch function which allows the user to use one amplifier for both receiver (earpiece) mode and ringer/loudspeaker mode. When the boost converter and the amplifier are both active the device is in ringer mode. This enables the boost converter and sets the externally configurable closed loop gain selection to BW1. If the boost converter is in the shutdown and the amplifier is active the device is in receiver mode. In this mode the gain selection is switched to BW2. This allows the amplifier to be powered directly from the battery minus the voltage drop across the Schottky diode.

	SD Boost	SD Amp
Receiver Mode (BW2)	Low	High
Boosted Ringer Mode (BW1)	High	High
Shutdown	Low	Low

BOOTSTRAP PIN

The bootstrap pin, featured in the LM4962, provides a voltage supply for the internal switch driver. Connecting the bootstrap pin to V1 (See [Figure 2](#)) allows for a higher voltage to drive the gate of the switch thereby reducing the R_{on} . This configuration is necessary in applications with heavier loads. The bootstrap pin can be connected to V_{DD} when driving lighter loads to improve device performance (I_{ddq} , THD+N, Noise, etc.).

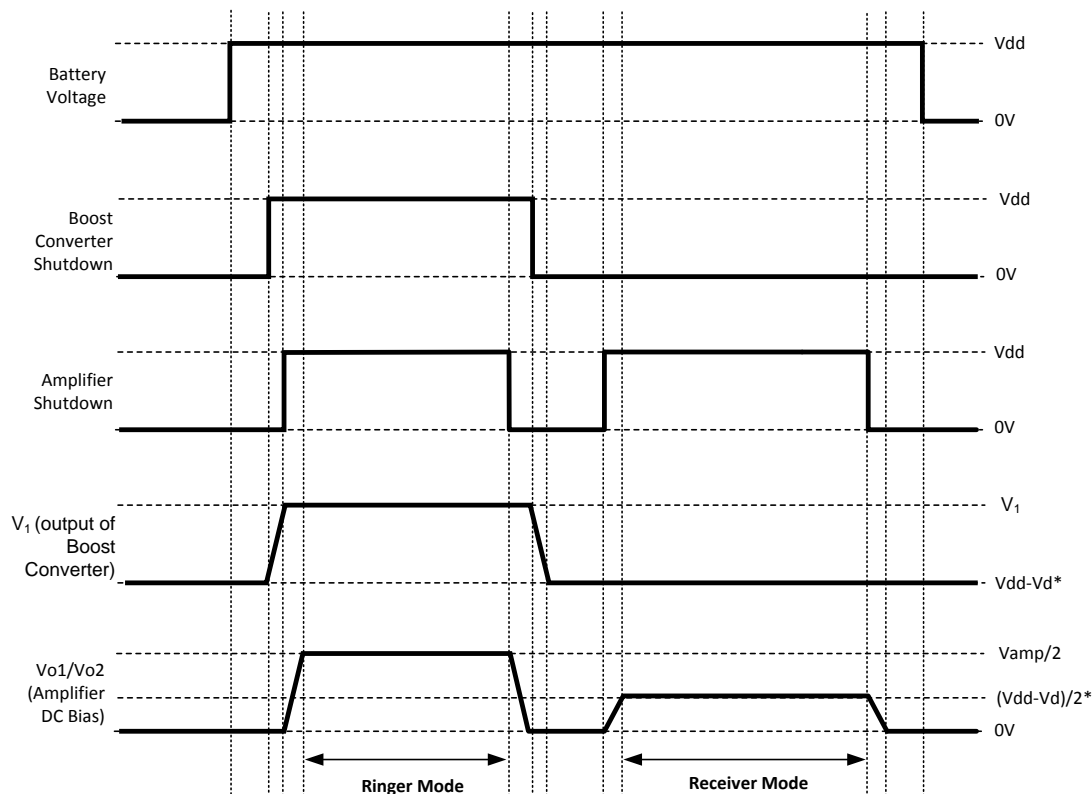

*V_d = Voltage drop across diode D2

Figure 20. Power on Sequence Timing Diagram

OVER-CURRENT AND OVER-VOLTAGE PROTECTION FUNCTION

Flagout Pin The Flagout pin indicates a fault when an over current or over voltage condition has been detected. The Flagout pin is high impedance when inactive. When active, the Flagout pin is pulled down to a 50Ω short to GND.

Over-Voltage Protection (OVP) Operation When a voltage (V_{amp}) greater than 8.5V (min) is detected at the OC/OV Detect pin, the LM4962 indicates a fault by activating the Flagout pin. The boost converter momentarily shutdown and reinitialize the soft-start sequence. The Flagout pin will remain active until both shutdown pins are pulled low.

Over-Current Protection (OCP) Operation The OCP circuitry monitors the voltage across R_{ocd} to detect the output current of the boost converter. If a voltage greater than 185mV (typ) is detected the device will shutdown and the Flagout pin will be activated. For the device to return to normal operation both shutdown pins need to be pulled low to reset the Flagout pin.

Disable OCP The Over-Current Protection Circuitry can be disabled by shorting out R_S. In this configuration the OVP circuitry is still active.

Disable both OVP and OCP Both features can be disabled by grounding the OC/OV Detect pin. In this configuration the Flagout pin will be inactive.

Timing Diagrams

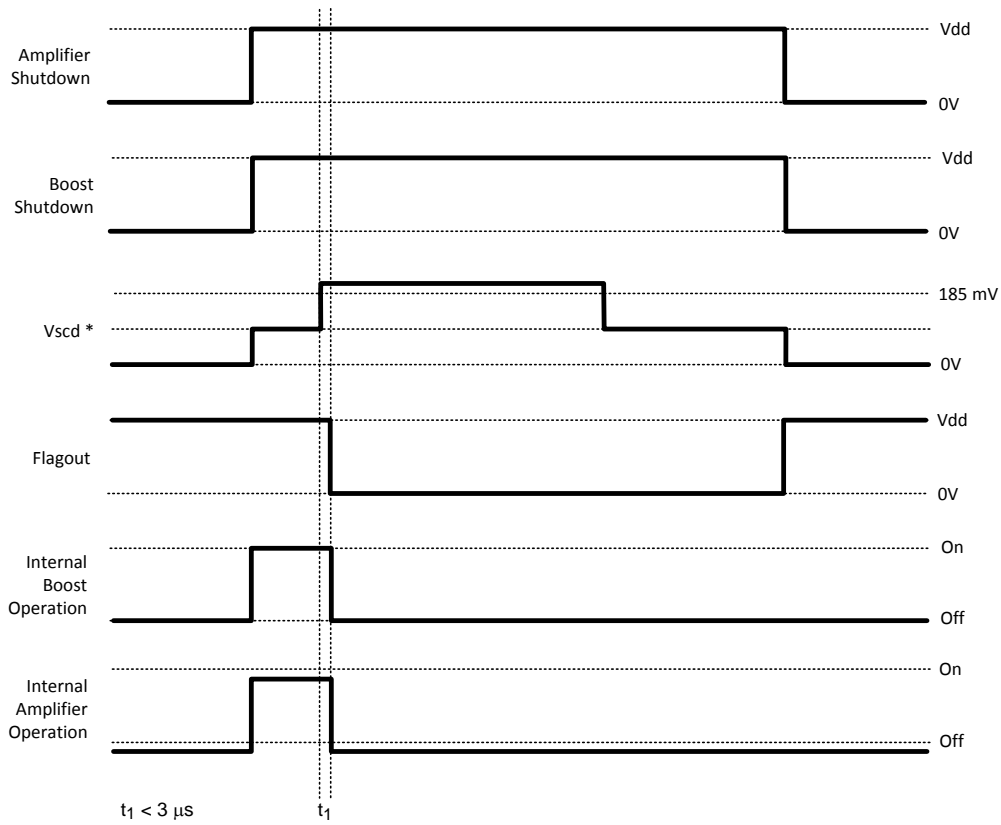

* Vscd refers to the voltage differential across Rs

Figure 21. OCP Timing Diagram

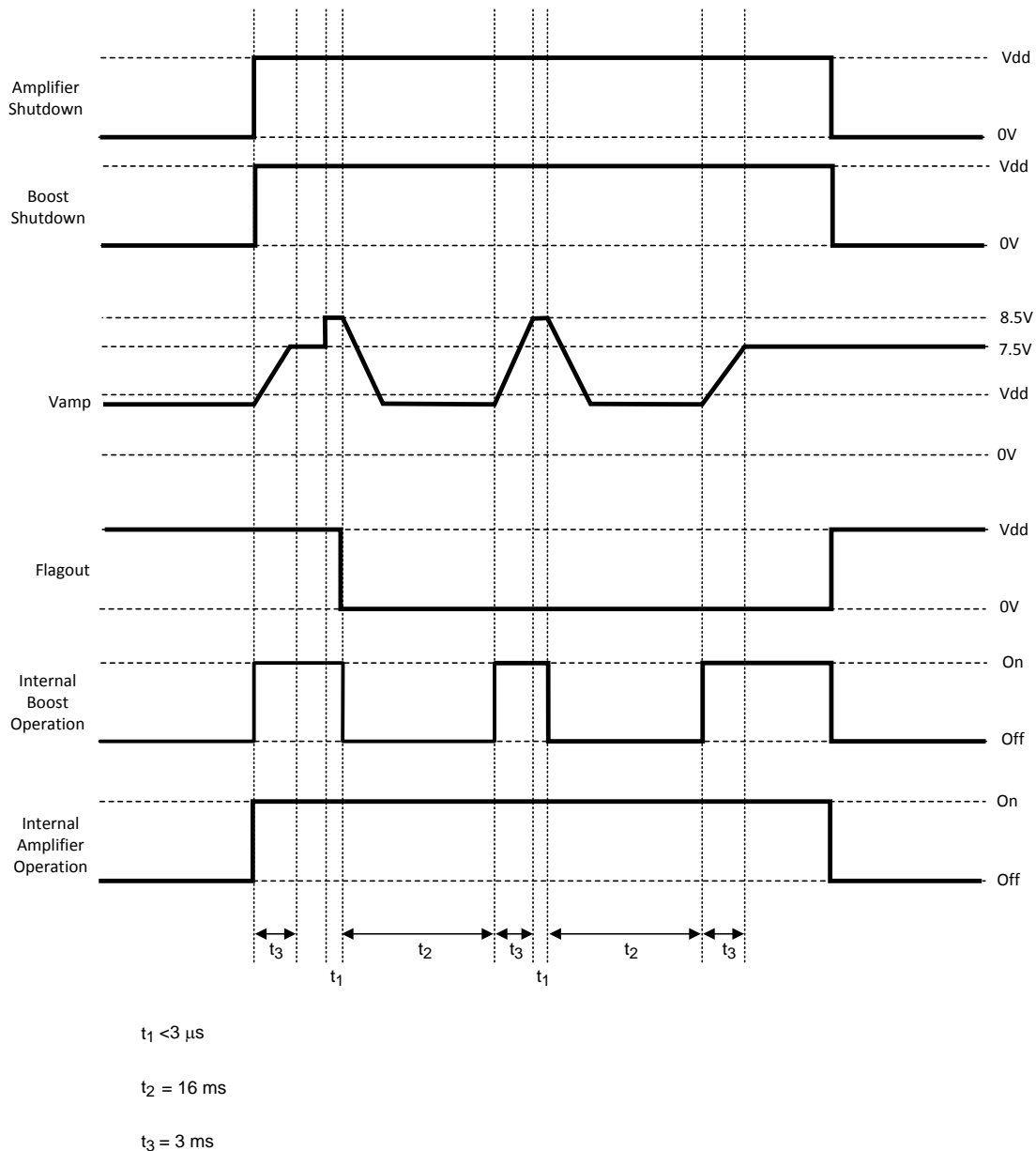

Figure 22. OVP Timing Diagram

PROPER SELECTION OF EXTERNAL COMPONENTS

Proper selection of external components in applications using integrated power amplifiers, and switching DC-DC converters, is critical for optimizing device and system performance. Consideration to component values must be used to maximize overall system quality.

The best capacitors for use with the switching converter portion of the LM4962 are multi-layer ceramic capacitors. They have the lowest ESR (equivalent series resistance) and highest resonance frequency, which makes them optimum for high frequency switching converters.

When selecting a ceramic capacitor, only X5R and X7R dielectric types should be used. Other types such as Z5U and Y5F have such severe loss of capacitance due to effects of temperature variation and applied voltage, they may provide as little as 20% of rated capacitance in many typical applications. Always consult capacitor manufacturer's data curves before selecting a capacitor. High-quality ceramic capacitors can be obtained from Taiyo-Yuden.

POWER SUPPLY BYPASSING

As with any amplifier, proper supply bypassing is critical for low noise performance and high power supply rejection. The capacitor location on both V₁ and V_{DD} pins should be as close to the device as possible.

SELECTING INPUT CAPACITOR FOR AUDIO AMPLIFIER

One of the major considerations is the closed-loop bandwidth of the amplifier. To a large extent, the bandwidth is dictated by the choice of external components shown in [Figure 2](#). The input coupling capacitor, C_i, forms a first order high pass filter which limits low frequency response. This value should be chosen based on needed frequency response for a few distinct reasons.

High value input capacitors are both expensive and space hungry in portable designs. Clearly, a certain value capacitor is needed to couple in low frequencies without severe attenuation. But ceramic speakers used in portable systems, whether internal or external, have little ability to reproduce signals below 100Hz to 150Hz. Thus, using a high value input capacitor may not increase actual system performance.

In addition to system cost and size, click and pop performance is affected by the value of the input coupling capacitor, C_i. A high value input coupling capacitor requires more charge to reach its quiescent DC voltage (nominally 1/2 V_{DD}). This charge comes from the output via the feedback and is apt to create pops upon device enable. Thus, by minimizing the capacitor value based on desired low frequency response, turn-on pops can be minimized.

SELECTING FEEDBACK CAPACITOR FOR AUDIO AMPLIFIER

The LM4962 is unity-gain stable which gives the designer maximum system flexibility. However, to drive ceramic speakers, a typical application requires a closed-loop differential gain of 10. In this case a feedback capacitor (C_{f2}) will be needed as shown in [Figure 2](#) to bandwidth limit the amplifier.

This feedback capacitor creates a low pass filter that eliminates possible high frequency noise. Care should be taken when calculating the -3dB frequency because an incorrect combination of R_f and C_{f2} will cause rolloff before the desired frequency

SELECTING OUTPUT CAPACITOR (C₂) FOR BOOST CONVERTER

A single 4.7μF to 10μF ceramic capacitor will provide sufficient output capacitance for most applications. If larger amounts of capacitance are desired for improved line support and transient response, tantalum capacitors can be used. Aluminum electrolytics with ultra low ESR such as Sanyo Oscon can be used, but are usually prohibitively expensive. Typical Al electrolytic capacitors are not suitable for switching frequencies above 500 kHz because of significant ringing and temperature rise due to self-heating from ripple current. An output capacitor with excessive ESR can also reduce phase margin and cause instability.

In general, if electrolytics are used, we recommended that they be paralleled with ceramic capacitors to reduce ringing, switching losses, and output voltage ripple.

SELECTING INPUT CAPACITOR (C_{s1}) FOR BOOST CONVERTER

An input capacitor is required to serve as an energy reservoir for the current which must flow into the coil each time the switch turns ON. This capacitor must have extremely low ESR, so ceramic is the best choice. We recommend a nominal value of 4.7μF, but larger values can be used. Since this capacitor reduces the amount of voltage ripple seen at the input pin, it also reduces the amount of EMI passed back along that line to other circuitry.

SETTING THE OUTPUT VOLTAGE (V₁) OF BOOST CONVERTER

The output voltage is set using the external resistors R₂ and R₅ (see [Figure 2](#)). A value of approximately 25kΩ is recommended for R₂ to establish the open loop gain of the boost converter.

$$V_1 = V_{FB} [1 + (R_2 / R_5)] \quad (6)$$

FEED-FORWARD COMPENSATION FOR BOOST CONVERTER

Although the LM4962's internal Boost converter is internally compensated, the external feed-forward capacitor C_f is required for stability (see [Figure 2](#)). Adding this capacitor puts a zero in the loop response of the converter. The recommended frequency for the zero f_z should be approximately 60kHz. C_3 can be calculated using the formula:

$$C_3 = 1 / (2\pi \times R_2 \times f_z) \quad (7)$$

SELECTING A SOFT-START CAPACITOR (C_{ss})

The soft-start function charges the boost converter reference voltage slowly, which allows the output of the boost converter to ramp up slowly thus limiting the transient current at startup.

Selecting a soft-start capacitor (C_{ss}) value presents a trade off between the wake-up time of the boost converter (T_{WUBC}) and the startup transient current. Using a larger capacitor value will increase wake-up time and decrease startup transient current; on the flip side, using a smaller capacitor value will decrease wake-up time and increase the transient current seen at startup. A standard rule of thumb is to use a capacitor 1000 times smaller than the output capacitance of the boost converter ($C_2 + C_{s2}$). A 10nF soft-start capacitor is recommended for a typical application.

SELECTING A VALUE FOR R_{chg}

The audio power amplifier integrated in the LM4962 is designed for very fast turn on time. The C_{chg} pin allows the input capacitor (C_{inA}) to charge quickly to improve click/pop performance. Resistor, R_{chg} , protects the C_{chg} pin from any over/under voltage conditions caused by excessive input signal, or an active input signal when the device is in shutdown. The recommended value for R_{chg} is 1k Ω . If the input signal is less than $V_{DD} + 0.3V$ and greater than $-0.3V$, and if the input signal is disabled when in shutdown mode, R_{chg} may be shorted.

SELECTING DIODES

The external diode used in [Figure 2](#) should be a Schottky diode. A 20V diode such as the MBR0520 from Fairchild Semiconductor is recommended.

The MBR05XX series of diodes are designed to handle a maximum average current of 0.5A. For applications exceeding 0.5A average but less than 1A, a Microsemi UPS5817 can be used.

DUTY CYCLE

The maximum duty cycle of the boost converter determines the maximum boost ratio of output-to-input voltage that the converter can attain in continuous mode of operation. The duty cycle for a given boost application is defined as:

$$\text{Duty Cycle} = (V_{OUT} + V_{DIODE} - V_{DD}) / (V_{AMP} + V_{DIODE} - V_{SW})$$

This applies for continuous mode operation.

INDUCTANCE VALUE

The first question we are usually asked is: "How small can I make the inductor." (because they are the largest sized component and usually the most costly). The answer is not simple and involves trade-offs in performance. Larger inductors mean less inductor ripple current, which typically means less output voltage ripple (for a given size of output capacitor). Larger inductors also mean more load power can be delivered because the energy stored during each switching cycle is:

$$E = L/2 \times (I_p)^2 \quad (8)$$

where:

" I_p " is the peak inductor current

An important point to observe is that the LM4962 will limit its switch current based on peak current. This means that since $I_p(\text{max})$ is fixed, increasing L will increase the maximum amount of power available to the load. Conversely, using too little inductance may limit the amount of load current which can be drawn from the output. Best performance is usually obtained when the converter is operated in “continuous” mode at the load current range of interest, typically giving better load regulation and less output ripple. Continuous operation is defined as not allowing the inductor current to drop to zero during the cycle. It should be noted that all boost converters shift over to discontinuous operation as the output load is reduced far enough, but a larger inductor stays “continuous” over a wider load current range. Taiyo-Yudens NR4012 inductor series is recommended.

MAXIMUM SWITCH CURRENT

The maximum FET switch current available before the current limiter cuts in is dependent on duty cycle of the application. This is illustrated in a graph in the [Typical Performance Characteristics](#) section which shows typical values of switch current as a function of effective (actual) duty cycle.

CALCULATING OUTPUT CURRENT OF BOOST CONVERTER (I_{AMP})

The load current of the Boost Converter is related to the average inductor current by the relation:

$$I_{\text{AMP}} = I_{\text{IND}}(\text{AVG}) \times (1 - \text{DC}) \quad (9)$$

Where "DC" is the duty cycle of the application. The switch current can be found by:

$$I_{\text{SW}} = I_{\text{IND}}(\text{AVG}) + 1/2 (I^{\text{RIPPLE}}) \quad (10)$$

Inductor ripple current is dependent on inductance, duty cycle, supply voltage and frequency:

$$I^{\text{RIPPLE}} = \text{DC} \times (V_{\text{DD}} - V_{\text{SW}}) / (f \times L) \quad (11)$$

combining all terms, we can develop an expression which allows the maximum available load current to be calculated:

$$I_{\text{AMP}}(\text{max}) = (1 - \text{DC}) \times (I_{\text{SW}}(\text{max}) - \text{DC}(V_{\text{DD}} - V_{\text{SW}})) / 2fL \quad (12)$$

The equation shown to calculate maximum load current takes into account the losses in the inductor or turn-OFF switching losses of the FET and diode.

DESIGN PARAMETERS V_{SW} AND I_{SW}

The value of the FET "ON" voltage (referred to as V_{SW} in Equations (9) thru (12) is dependent on load current. A good approximation can be obtained by multiplying the "ON Resistance" of the FET times the average inductor current.

The maximum peak switch current the device can deliver is dependent on duty cycle.

INDUCTOR SUPPLIERS

The recommended inductors for the LM4962 is the Taiyo-Yuden NR4012. When selecting an inductor, make certain that the continuous current rating is high enough to avoid saturation at peak currents. A suitable core type must be used to minimize core (switching) losses, and wire power losses must be considered when selecting the current rating.

REVISION HISTORY

Rev	Date	Description
1.0	03/31/06	Edited 20142203 and 06, then re-released D/S to the WEB.

Changes from Revision C (April 2013) to Revision D

Page

- Changed layout of National Data Sheet to TI format [17](#)

PACKAGING INFORMATION

Orderable Device	Status (1)	Package Type	Package Drawing	Pins	Package Qty	Eco Plan (2)	Lead/Ball Finish	MSL Peak Temp (3)	Op Temp (°C)	Top-Side Markings (4)	Samples
LM4962TL/NOPB	ACTIVE	DSBGA	YZR	20	250	Green (RoHS & no Sb/Br)	SNAGCU	Level-1-260C-UNLIM		GF7	Samples
LM4962TLX/NOPB	ACTIVE	DSBGA	YZR	20	3000	Green (RoHS & no Sb/Br)	SNAGCU	Level-1-260C-UNLIM		GF7	Samples

(1) The marketing status values are defined as follows:

ACTIVE: Product device recommended for new designs.

LIFEBUY: TI has announced that the device will be discontinued, and a lifetime-buy period is in effect.

NRND: Not recommended for new designs. Device is in production to support existing customers, but TI does not recommend using this part in a new design.

PREVIEW: Device has been announced but is not in production. Samples may or may not be available.

OBSOLETE: TI has discontinued the production of the device.

(2) Eco Plan - The planned eco-friendly classification: Pb-Free (RoHS), Pb-Free (RoHS Exempt), or Green (RoHS & no Sb/Br) - please check <http://www.ti.com/productcontent> for the latest availability information and additional product content details.

TBD: The Pb-Free/Green conversion plan has not been defined.

Pb-Free (RoHS): TI's terms "Lead-Free" or "Pb-Free" mean semiconductor products that are compatible with the current RoHS requirements for all 6 substances, including the requirement that lead not exceed 0.1% by weight in homogeneous materials. Where designed to be soldered at high temperatures, TI Pb-Free products are suitable for use in specified lead-free processes.

Pb-Free (RoHS Exempt): This component has a RoHS exemption for either 1) lead-based flip-chip solder bumps used between the die and package, or 2) lead-based die adhesive used between the die and leadframe. The component is otherwise considered Pb-Free (RoHS compatible) as defined above.

Green (RoHS & no Sb/Br): TI defines "Green" to mean Pb-Free (RoHS compatible), and free of Bromine (Br) and Antimony (Sb) based flame retardants (Br or Sb do not exceed 0.1% by weight in homogeneous material)

(3) MSL, Peak Temp. -- The Moisture Sensitivity Level rating according to the JEDEC industry standard classifications, and peak solder temperature.

(4) Multiple Top-Side Markings will be inside parentheses. Only one Top-Side Marking contained in parentheses and separated by a "~" will appear on a device. If a line is indented then it is a continuation of the previous line and the two combined represent the entire Top-Side Marking for that device.

Important Information and Disclaimer: The information provided on this page represents TI's knowledge and belief as of the date that it is provided. TI bases its knowledge and belief on information provided by third parties, and makes no representation or warranty as to the accuracy of such information. Efforts are underway to better integrate information from third parties. TI has taken and continues to take reasonable steps to provide representative and accurate information but may not have conducted destructive testing or chemical analysis on incoming materials and chemicals. TI and TI suppliers consider certain information to be proprietary, and thus CAS numbers and other limited information may not be available for release.

In no event shall TI's liability arising out of such information exceed the total purchase price of the TI part(s) at issue in this document sold by TI to Customer on an annual basis.

TAPE AND REEL INFORMATION



QUADRANT ASSIGNMENTS FOR PIN 1 ORIENTATION IN TAPE



*All dimensions are nominal

Device	Package Type	Package Drawing	Pins	SPQ	Reel Diameter (mm)	Reel Width W1 (mm)	A0 (mm)	B0 (mm)	K0 (mm)	P1 (mm)	W (mm)	Pin1 Quadrant
LM4962TL/NOPB	DSBGA	YZR	20	250	178.0	8.4	2.18	2.69	0.76	4.0	8.0	Q1
LM4962TLX/NOPB	DSBGA	YZR	20	3000	178.0	8.4	2.18	2.69	0.76	4.0	8.0	Q1

TAPE AND REEL BOX DIMENSIONS

*All dimensions are nominal

Device	Package Type	Package Drawing	Pins	SPQ	Length (mm)	Width (mm)	Height (mm)
LM4962TL/NOPB	DSBGA	YZR	20	250	210.0	185.0	35.0
LM4962TLX/NOPB	DSBGA	YZR	20	3000	210.0	185.0	35.0

YZR0020

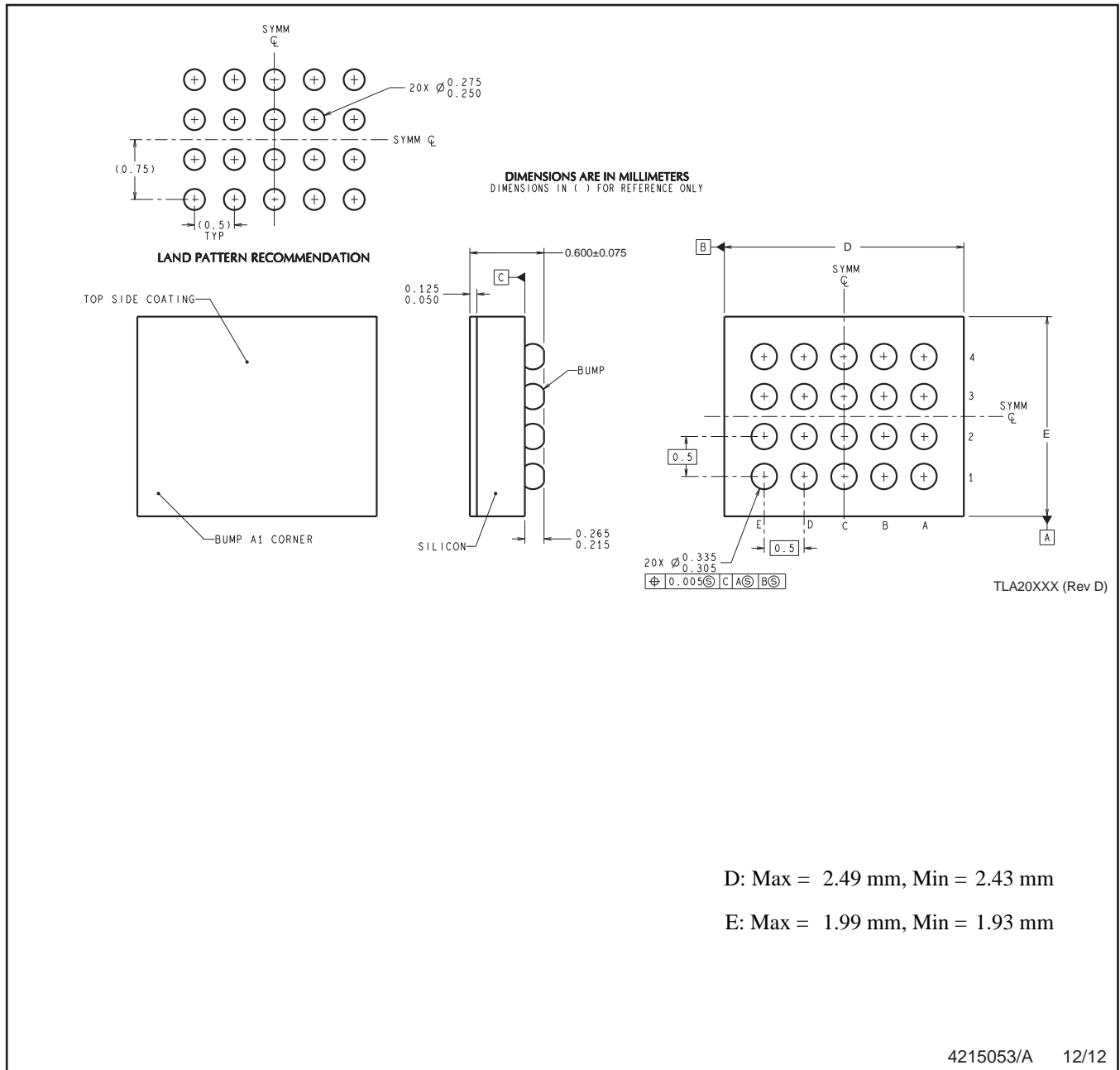

NOTES: A. All linear dimensions are in millimeters. Dimensioning and tolerancing per ASME Y14.5M-1994.
B. This drawing is subject to change without notice.

4215053/A 12/12

IMPORTANT NOTICE

Texas Instruments Incorporated and its subsidiaries (TI) reserve the right to make corrections, enhancements, improvements and other changes to its semiconductor products and services per JESD46, latest issue, and to discontinue any product or service per JESD48, latest issue. Buyers should obtain the latest relevant information before placing orders and should verify that such information is current and complete. All semiconductor products (also referred to herein as "components") are sold subject to TI's terms and conditions of sale supplied at the time of order acknowledgment.

TI warrants performance of its components to the specifications applicable at the time of sale, in accordance with the warranty in TI's terms and conditions of sale of semiconductor products. Testing and other quality control techniques are used to the extent TI deems necessary to support this warranty. Except where mandated by applicable law, testing of all parameters of each component is not necessarily performed.

TI assumes no liability for applications assistance or the design of Buyers' products. Buyers are responsible for their products and applications using TI components. To minimize the risks associated with Buyers' products and applications, Buyers should provide adequate design and operating safeguards.

TI does not warrant or represent that any license, either express or implied, is granted under any patent right, copyright, mask work right, or other intellectual property right relating to any combination, machine, or process in which TI components or services are used. Information published by TI regarding third-party products or services does not constitute a license to use such products or services or a warranty or endorsement thereof. Use of such information may require a license from a third party under the patents or other intellectual property of the third party, or a license from TI under the patents or other intellectual property of TI.

Reproduction of significant portions of TI information in TI data books or data sheets is permissible only if reproduction is without alteration and is accompanied by all associated warranties, conditions, limitations, and notices. TI is not responsible or liable for such altered documentation. Information of third parties may be subject to additional restrictions.

Resale of TI components or services with statements different from or beyond the parameters stated by TI for that component or service voids all express and any implied warranties for the associated TI component or service and is an unfair and deceptive business practice. TI is not responsible or liable for any such statements.

Buyer acknowledges and agrees that it is solely responsible for compliance with all legal, regulatory and safety-related requirements concerning its products, and any use of TI components in its applications, notwithstanding any applications-related information or support that may be provided by TI. Buyer represents and agrees that it has all the necessary expertise to create and implement safeguards which anticipate dangerous consequences of failures, monitor failures and their consequences, lessen the likelihood of failures that might cause harm and take appropriate remedial actions. Buyer will fully indemnify TI and its representatives against any damages arising out of the use of any TI components in safety-critical applications.

In some cases, TI components may be promoted specifically to facilitate safety-related applications. With such components, TI's goal is to help enable customers to design and create their own end-product solutions that meet applicable functional safety standards and requirements. Nonetheless, such components are subject to these terms.

No TI components are authorized for use in FDA Class III (or similar life-critical medical equipment) unless authorized officers of the parties have executed a special agreement specifically governing such use.

Only those TI components which TI has specifically designated as military grade or "enhanced plastic" are designed and intended for use in military/aerospace applications or environments. Buyer acknowledges and agrees that any military or aerospace use of TI components which have **not** been so designated is solely at the Buyer's risk, and that Buyer is solely responsible for compliance with all legal and regulatory requirements in connection with such use.

TI has specifically designated certain components as meeting ISO/TS16949 requirements, mainly for automotive use. In any case of use of non-designated products, TI will not be responsible for any failure to meet ISO/TS16949.

Products

Audio	www.ti.com/audio
Amplifiers	amplifier.ti.com
Data Converters	dataconverter.ti.com
DLP® Products	www.dlp.com
DSP	dsp.ti.com
Clocks and Timers	www.ti.com/clocks
Interface	interface.ti.com
Logic	logic.ti.com
Power Mgmt	power.ti.com
Microcontrollers	microcontroller.ti.com
RFID	www.ti-rfid.com
OMAP Applications Processors	www.ti.com/omap
Wireless Connectivity	www.ti.com/wirelessconnectivity

Applications

Automotive and Transportation	www.ti.com/automotive
Communications and Telecom	www.ti.com/communications
Computers and Peripherals	www.ti.com/computers
Consumer Electronics	www.ti.com/consumer-apps
Energy and Lighting	www.ti.com/energy
Industrial	www.ti.com/industrial
Medical	www.ti.com/medical
Security	www.ti.com/security
Space, Avionics and Defense	www.ti.com/space-avionics-defense
Video and Imaging	www.ti.com/video

TI E2E Community

e2e.ti.com