

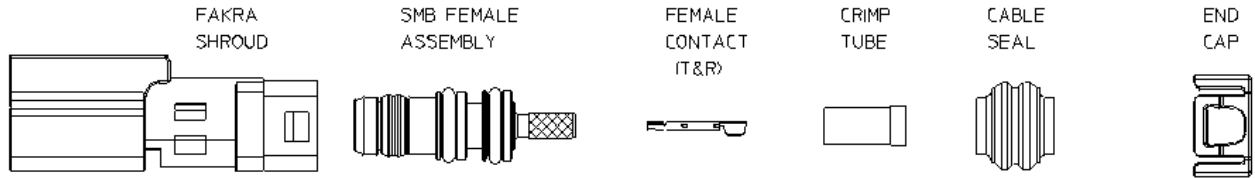

# APPLICATION SPECIFICATION



ISL NO  
CLIP SLOT



ISL 7 mm  
CLIP SLOT

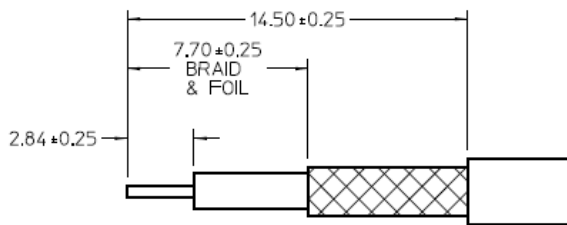
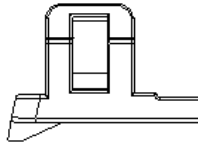

1. STRIP CABLE TO DIMENSIONS SHOWN.

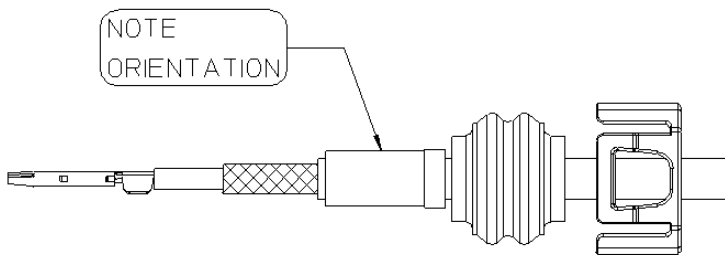

- 2.1 SLIDE ONTO CABLE IN ORDER SHOWN, END CAP, CABLE SEAL, & CRIMP TUBE (ORIENTED).
- 2.2 INSERT CABLE CENTER CONDUCTOR INTO CONTACT AS SHOWN.
- 2.3 CRIMP THE CONTACT WITH DIE SET AND APPLICATORS SHOWN ON SHEET 2 (FIG 1) OR MOLEX TOOL NUMBER 63904-0100 OR MOLEX HAND TOOL NUMBER 63827-9200/63827-9270

REVISION: <b>D</b>	ECR/ECN INFORMATION: EC No: 121560 DATE: 2017/09/06	TITLE: <b>CABLE ASSEMBLY INSTRUCTIONS FOR 73403-037X SEALED FAKRA</b>	SHEET No. <b>1 of 4</b>
DOCUMENT NUMBER: <b>AS-89675-452</b>	CREATED / REVISED BY: <b>AZR/SSS</b>	CHECKED BY: <b>SSS</b>	APPROVED BY: <b>WES</b>
<small>TEMPLATE FILENAME: APPLICATION_SPEC(SIZE_A4)(V.1).DOC</small>			

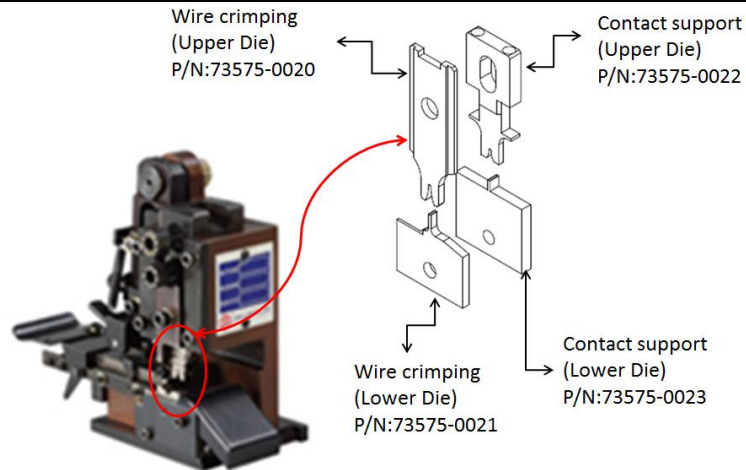

Specific applicators model:  
CLM-4S

FIGURE 1

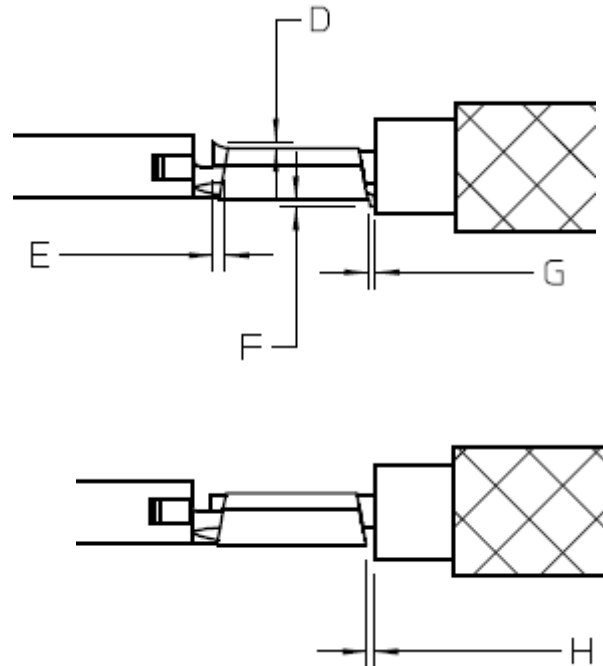
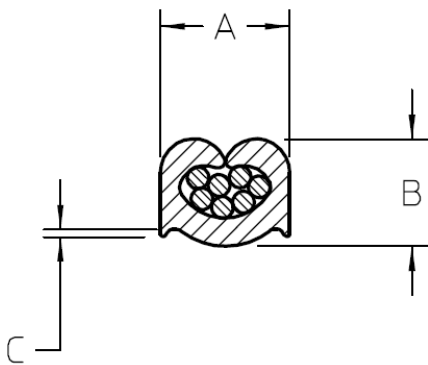

TABLE 1

CABLE TYPES	A DIM (mm)	B DIM. (mm)	C DIM. (mm)	D DIM. (mm)	E DIM. (mm)	F DIM. (mm)	G DIM. (mm)	H DIM. (mm)
LEONI DACAR 462 LEONI DACAR 107-2	1.09±0.03	0.83±0.03	0.2 MAX.	0.1 MAX.	0.8 MAX.	0.1 MAX.	0.1 MAX.	0.3 MAX.

\*The retention force MUST meet min. 5 pound (22.2 Newton).

REVISION: <b>D</b>	ECR/ECN INFORMATION: EC No: 121560 DATE: 2017/09/06	TITLE: <b>CABLE ASSEMBLY INSTRUCTIONS FOR 73403-037X SEALED FAKRA</b>	SHEET No. <b>2 of 4</b>
DOCUMENT NUMBER: <b>AS-89675-452</b>	CREATED / REVISED BY: <b>AZR/SSS</b>	CHECKED BY: <b>SSS</b>	APPROVED BY: <b>WES</b>
<small>TEMPLATE FILENAME: APPLICATION_SPEC(SIZE_A4)(V.1).DOC</small>			



# APPLICATION SPECIFICATION

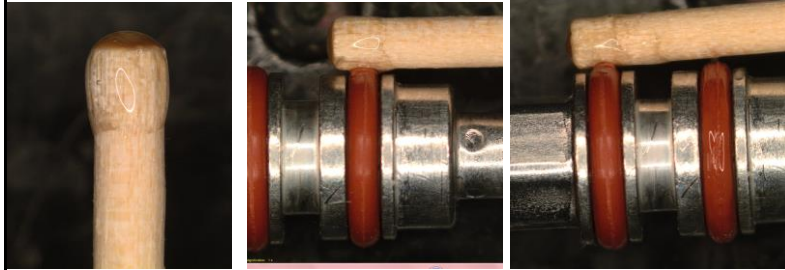
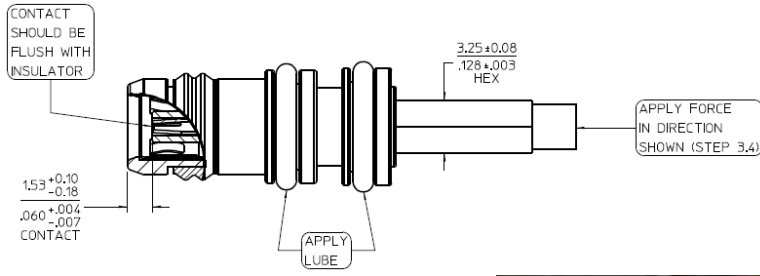

- 3.1 FLARE OUT BRAID AND FOIL.
- 3.2 INSERT CABLE/CONTACT INTO SMB ASSEMBLY TO CONTACT DIMENSION.
- 3.3 BRING FORWARD CRIMP TUBE OVER BRAID/FOIL UNTIL BOTTOMED ON SMB ASSEMBLY BODY.
- 3.4 CRIMP USING 3.25/.128 HEX DIE. APPLY FORCE IN DIRECTION SHOWN ON CABLE DURING CRIMP OPERATION.
- 3.5 APPLY SILICONE BASE O-RING LUBE TO APPLICATOR (PARKER SUPER O LUBE RECOMMENDED)
- 3.6 USING APPLICATOR, APPLY A THIN LAYER UNIFORMLY TO FRONT AND REAR O-RINGS AS SHOWN

FULLY SEAT CABLE SEAL BEFORE INSTALLING END CAP

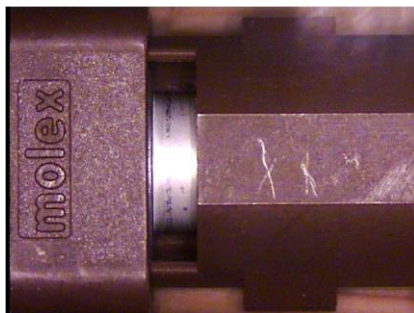
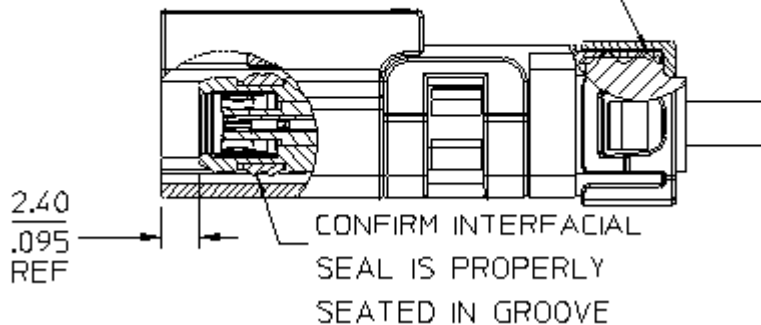

FIGURE 1

- 4.1 INSERT SMB ASSEMBLY INTO FAKRA HOUSING BY APPLYING STEADY FORCE AND GENTLY ROTATING WHILE INSERTING, UNTIL POSITIVE STOP.
- 4.2 INSPECT INTERFACIAL SEAL FOR PROPER SEATING IN GROOVE
- 4.3 O-RING SHOULD NOT BE VISIBLE THRU WINDOW. FIGURE 1 SHOWS CORRECT INSTALLATION
- 4.4 INSERT ISL INTO FAKRA HOUSING UNTIL SNAPPED INTO FINAL LOCK POSITION.
- 4.5 BRING FORWARD CABLE SEAL UNTIL FULLY INSERTED INSIDE FAKRA HOUSING.
- 4.6 BRING FORWARD END CAP AND SNAP ONTO FAKRA HOUSING.

REVISION: <b>D</b>	ECR/ECN INFORMATION: EC No: 121560 DATE: 2017/09/06	TITLE: <b>CABLE ASSEMBLY INSTRUCTIONS FOR 73403-037X SEALED FAKRA</b>	SHEET No. <b>3 of 4</b>
DOCUMENT NUMBER: <b>AS-89675-452</b>	CREATED / REVISED BY: <b>AZR/SSS</b>	CHECKED BY: <b>SSS</b>	APPROVED BY: <b>WES</b>
TEMPLATE FILENAME: APPLICATION_SPEC(SIZE_A4)(V.1).DOC			



# APPLICATION SPECIFICATION



FIGURE 2

5.1 FOR S3 APPLICATIONS WRAP REAR CAP WITH TAPE AS SHOWN IN FIGURE 2. TAPE SHOULD EXTEND A MINIMUM OF 1 INCH FROM REAR OF END CAP. USE TESA 51036 ANTI ABRASION WIRE HARNESS TAPE (FASTENAL PART NUMBER: 10424-07244)



REVISION: <b>D</b>	ECR/ECN INFORMATION: EC No: 121560 DATE: 2017/09/06	TITLE: <b>CABLE ASSEMBLY INSTRUCTIONS FOR 73403-037X SEALED FAKRA</b>	SHEET No. <b>4 of 4</b>
DOCUMENT NUMBER: <b>AS-89675-452</b>	CREATED / REVISED BY: <b>AZR/SSS</b>	CHECKED BY: <b>SSS</b>	APPROVED BY: <b>WES</b>
<small>TEMPLATE FILENAME: APPLICATION_SPEC(SIZE_A4)(V.1).DOC</small>			