

SRA
— SHOPS

24 WALPOLE PARK SOUTH, SUITE #10
WALPOLE, MA 02081
UNITED STATES

SRA | **TruPower**
PROFESSIONAL SERIES



PROFESSIONAL SERIES
ULTRASONIC CLEANERS

FEATURING

**ADJUSTABLE POWER AND HEAT • SWEEPING FUNCTION
DEGASING FUNCTION • MEMORY FUNCTION
TIMER • SLEEP MODE**

PLEASE READ THIS MANUAL BEFORE USING

WARRANTY INFORMATION

1 YEAR - 100% GUARANTEE

All New Products come with a 1 Year - 100% Guarantee. The first 30 Days are covered by a Money Back or Replacement Guarantee. If your product is found to be defective or becomes defective through normal use during this first 30 day period, we will replace your unit at no charge or issue a complete refund for the product and we will pay all shipping costs involved.

The remainder of the 1 Year Period (after the first 30 days) is covered by a Free Parts & Labor Guarantee. If your product stops working or becomes defective during this period, return the product to us and we will repair your product with Free OEM parts and No Labor Charges. Shipping to us is paid by the buyer.

RETURNS OF NEW/UNUSED PRODUCTS:

We allow returns for New/Unused Products within the first 30 days of purchase should you have "Buyer's Remorse". Your product must be returned NEW and UNUSED in the original box including all parts and original packaging.

There is a 15% Restocking Fee for Buyer's Remorse for new/unused returns and the buyer must pay return shipping.

For warranty inquiries please contact
repairs@sra-solder.com
Thank you!

SRA
— SHOPS

24 WALPOLE PARK SOUTH, SUITE #10
WALPOLE, MA 02081
UNITED STATES

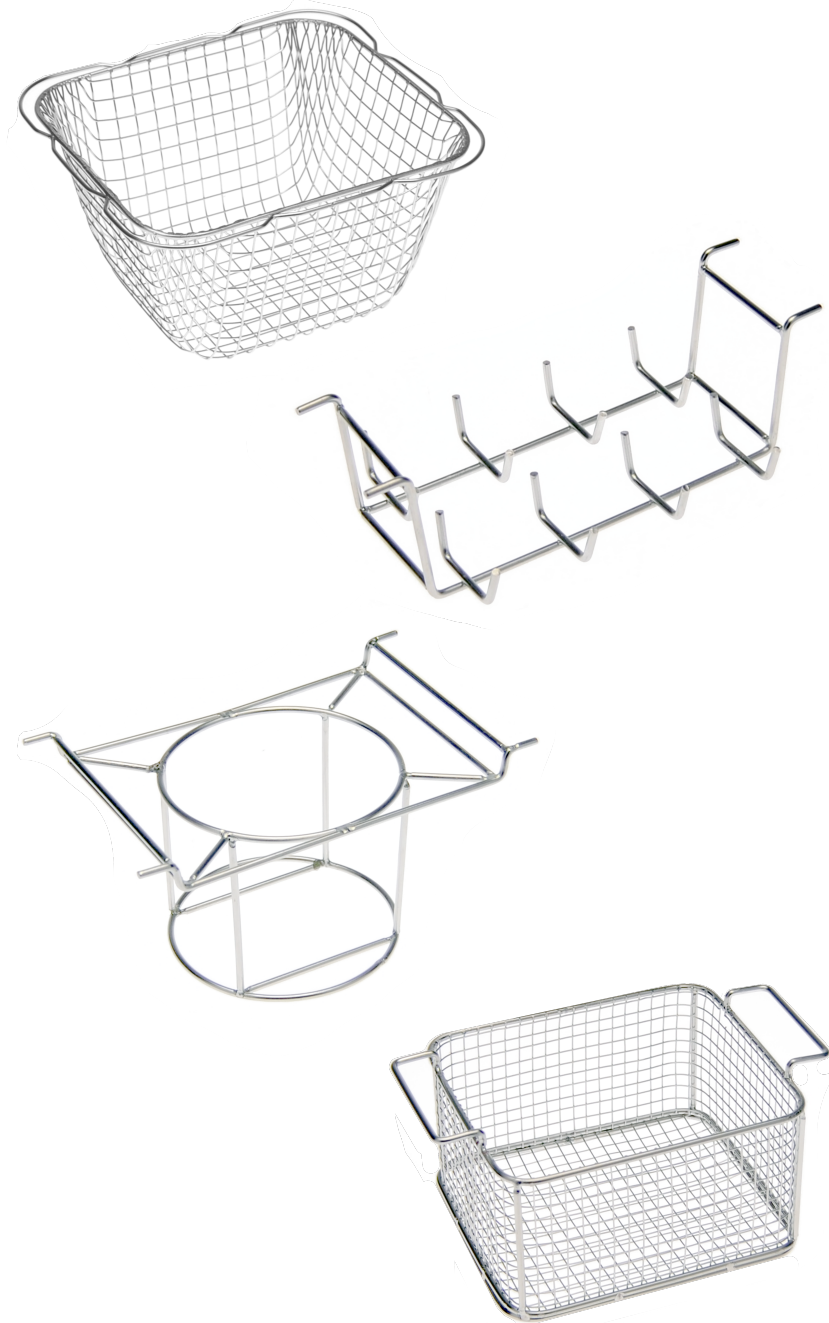

TABLE OF CONTENTS

TABLE OF CONTENTS.....3

FEATURES AND ACCESSORIES.....4

GENERAL GUIDELINES.....5

COMMON APPLICATIONS.....6

PANEL OVERVIEW.....7

OPERATING INSTRUCTIONS.....8

SETTING THE TIMER.....8

SETTING ULTRASONIC POWER.....9

SETTING THE TEMPERATURE.....9

SWEEP FUNCTION.....9

DEGAS FUNCTION.....9

SLEEP MODE.....9

MEMORY FUNCTION.....9

SPECIFICATIONS.....10

WARRANTY INFORMATION.....11

SPRA | TruPower

PROFESSIONAL SERIES

ULTRASONIC SPECIFICATIONS

MODEL (SKU)	CAPACITY (L)	TANK SIZE (mm)	TRANSDUCERS	ULTRASONIC POWER (MAX)	HEATING POWER (MAX)	FREQUENCY (kHz)	TIMER (mins)
UC-20D-PRO	2.0	150 x 135 x 100	1	70	60	40	1-99
UC-32D-PRO	3.2	240 x 135 x 100	2	120	200	40	1-99
UC-45D-PRO	4.5	300 x 150 x 100	3	180	200	40	1-99
UC-65D-PRO	6.5	300 x 150 x 150	3	180	400	40	1-99
UC-100D-PRO	10	300 x 240 x 150	4	240	500	40	1-99
UC-150D-PRO	15	330 x 300 x 150	6	360	1000	40	1-99
UC-200D-PRO	20	330 x 300 x 200	6	360	1000	40	1-99
UC-300D-PRO	30	500 x 300 x 200	10	600	1000	40	1-99

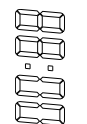
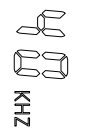
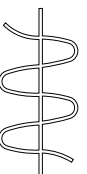
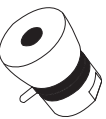
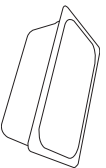
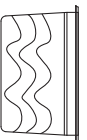
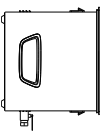

QUESTIONS?

CALL US TOLL FREE
1-800-545-4570

FEATURES AND ACCESSORIES

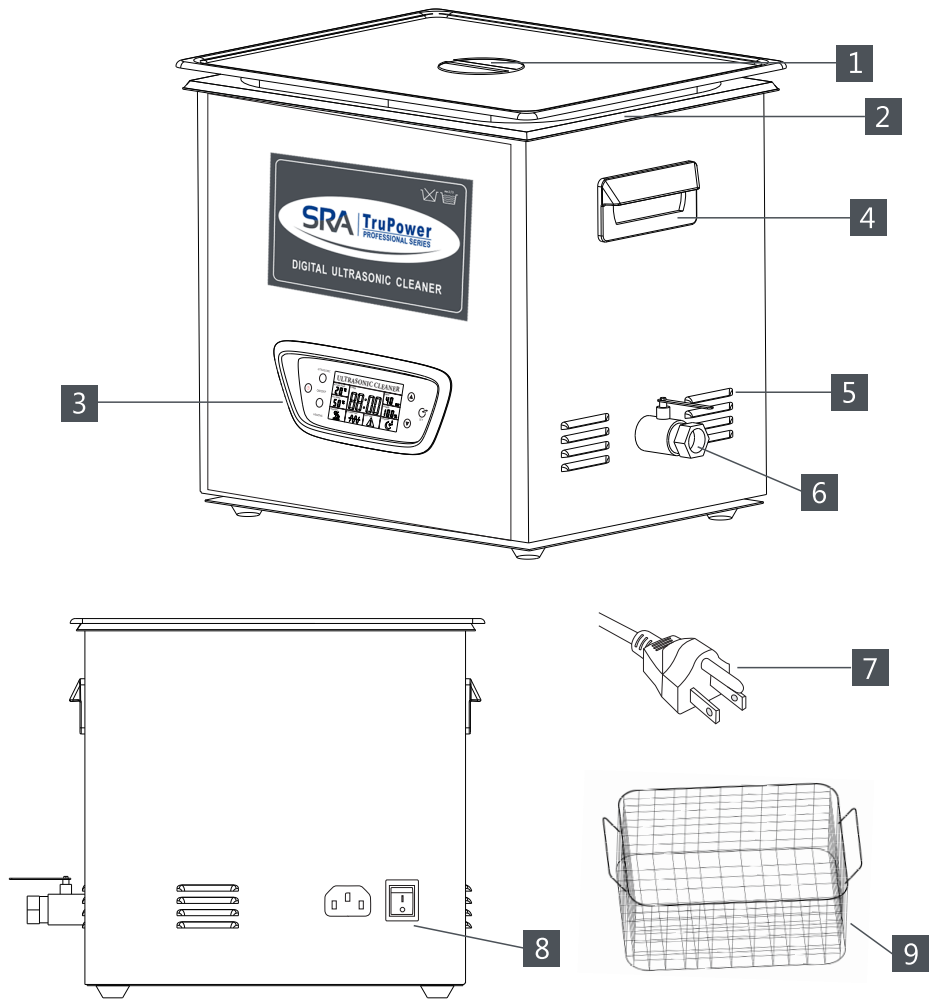

1 LID 2 STAINLESS STEEL TANK 3 LCD DISPLAY / CONTROL PANEL 4 HANDLES

5 HEAT DISSIPATION VENTS 6 DRAINAGE VALVE* 7 POWER CORD

8 POWER INLET AND SWITCH* 9 CLEANING BASKET(S)**

*LOCATION OF POWER SWITCH MAY DIFFER FROM MODEL TO MODEL

**PRESENCE OF DRAINAGE VALVE AND INCLUDED BASKETS DEPENDS ON MODEL

OPERATION INSTRUCTIONS

PART 2

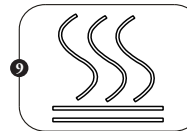

SETTING THE TEMPERATURE

Press the “SET” button until the “SET TEMP” icon is flashing, use adjustment buttons to select your desired temp setting. (Each button press will adjust temp by 1 degree Celsius or you can hold for continuous). Once finished setting the temp press the heating on/off button to start heating. The heating working status icon will flash. If the actual temp is \geq the set temp, heating will stop and the status icon will disappear. To stop heating function press the heating on/off button once more.

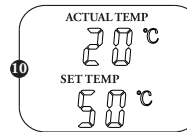

ACTUAL TEMP
is actual current temp

Note: The unit will not enter sleep mode during heating.
(read more about sleep function below)

WARNING



If you switch on the heater without water or other cleaning fluid in the tank, once the temp reaches the warning temperature it will trigger an alarm for 15 seconds; the triangle “WARNING” icon will appear on the screen.

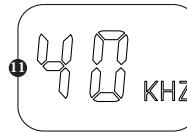

SWEEP FUNCTION

With ultrasonic on press the “UP” adjustment button directly to start the sweep function, the “FREQ” icon flashes. To stop the sweep function press the “UP” button once more.

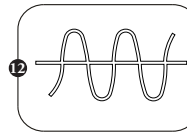

DEGAS FUNCTION

With ultrasonic on press the “DOWN” adjustment button directly to start the degas function, the “ULTRASONIC” icon flashes. To stop the degas function press the “DOWN” button once more.



SLEEPING MODE

After completed cleaning if the machine is left untouched for 5 minutes it will enter sleep mode. Alternatively you can press the power button to enter sleep mode. The “SLEEPING” icon will light when in sleep mode. To return to active mode from sleep mode simply press the “POWER” button.

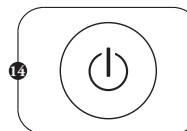

MEMORY FUNCTION

This unit will automatically save the most recently used setup parameters for next use. To repeat the last cleaning after entering sleep mode press the power button to re-activate the unit. You can now continue cleaning as normal using previous settings.

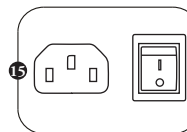

When the unit is not in use please turn off the power switch in rear and unplug the power cable directly.

OPERATION INSTRUCTIONS

PART 1

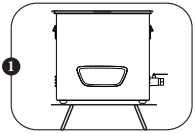

GETTING STARTED

Place the unit on a flat and stable working platform.



Please add enough cleaning fluid (usually water) to the tank to completely immerse the items to be cleaned. The fluid level in the tank should always be about 2/3 full.

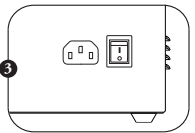

Connect the grounded power cable and turn on the power switch at the rear of the unit. The backlight of the LCD display will illuminate. If no setup parameters need to be changed, you can simply press the ultrasonic on/off button to start the cleaning. If you would like to reset the heating temperature, timer or power level, please refer to the instructions below.

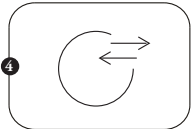

First press the “SET” button to select the item you wish to set up, with each press of the button the 3 items will flash in the following order:

SET TEMP → TIMER → POWER

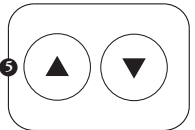

Once the desired item is flashing use the adjustment buttons to set the parameter (item will time out and stop flashing if left untouched for more than 10 seconds.)

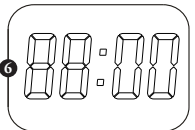

SETTING THE TIMER

Press the “SET” button until the “TIMER” window starts flashing, then use the adjustment buttons to select your desired cleaning time. The time range is adjustable from 1-99 minutes (Each button press adjusts timer by 1 minute or you can hold for continuous)

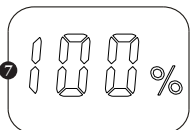

SETTING THE ULTRASONIC POWER

Press the “SET” button until the “POWER” icon is flashing, then use the adjustment buttons to select your desired power level. The power level is adjustable from 10% to 100% (Each button press will adjust the power level by 10% or you can hold for continuous)

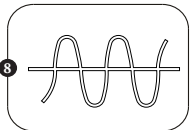

Press the ultrasonic on/off button to switch on the ultrasonic function, the “ULTRASONIC” icon will light up. Pressing the button a second time will turn off the ultrasonic function and the light will go out.

GENERAL GUIDELINES

1. Do not operate this unit without either water or cleaning fluid in the tank as damage may occur.
2. Do not use any corrosive cleaning fluid with strong acidity or alkalinity to avoid damage to the tank.
3. Before turning on the heating function fill the tank 1/2 – 2/3 full with water or cleaning fluid to prevent damage from the heating element.
4. Do not allow any objects or cleaning fluid to enter inside of the machine.
5. Do not operate the unit continuously for more than 99 minutes and please wait more than 30 minutes before next use otherwise the lifetime of the unit will be shortened.
6. Whenever emptying or replacing water or cleaning fluid make sure that the water or cleaning fluid in the tank is at room temperature or cool. Also be sure to turn off the device and unplug the power cord during this process.
7. After finished using wipe down the stainless steel tank and housing with a clean dry cloth. DO NOT wash the unit with water directly.
8. This unit should be stored in a cool dry place away from any heat sources and moisture.

COMMON APPLICATIONS

LAB ITEMS



Test tubes, beakers, flasks, etc.

PRECISION PARTS



Bearings, gears, valves, tools, brass, etc.

PCB/INK CARTRIDGES

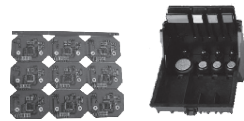

PCBs, ink cartridges, etc.

COLLECTIONS



Coins, badges, etc.

HOUSEHOLD/ JEWELRY



Necklaces, eyeglasses, watch bands, rings, earrings, etc.

MEDICAL/DENTAL INSTRUMENTS



Surgical instruments, pliers, handpieces, etc.

GOLFING



Golf clubs and golf balls

ELECTRONIC PARTS



Electronic parts and components

LENSES/CRYSTALS

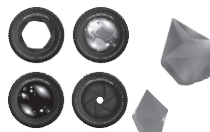

Lenses, crystals

PANEL OVERVIEW

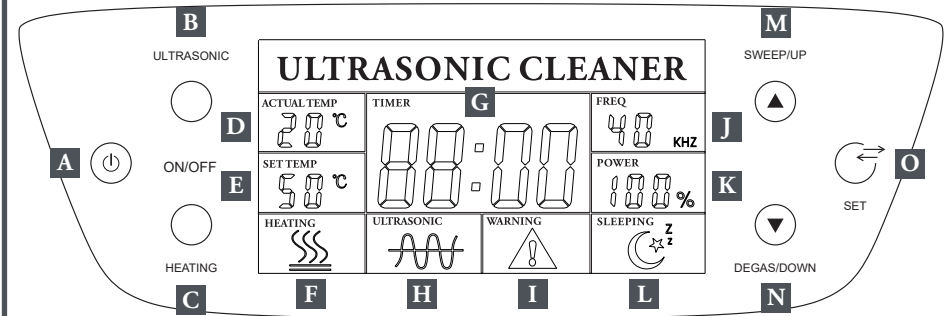
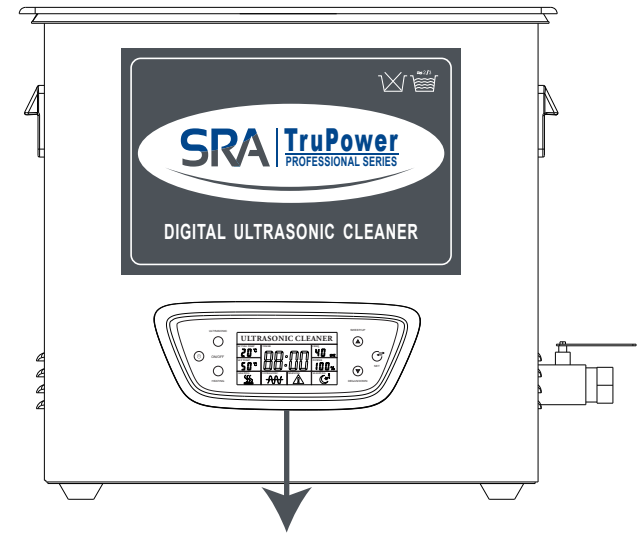

- A** POWER BUTTON
- B** ULTRASONIC ON/OFF
- C** HEATING ON/OFF
- D** ACTUAL TEMP
- E** USER SET TEMP
- F** HEATING WORKING STATUS
- G** TIMER WINDOW
- H** ULTRASONIC WORKING STATUS
- I** WARNING ICON
- J** FREQUENCY DISPLAY
- K** POWER LEVEL
- L** SLEEPING MODE
- M** SWEEP / UP ADJUST
- N** DEGAS / DOWN ADJUST
- O** SET BUTTON