

PAGE 1/2	ISSUE 26-03-18A	SERIES CHARGE	PART NUMBER R404567000
----------	------------------------	-------------------------	-------------------------------

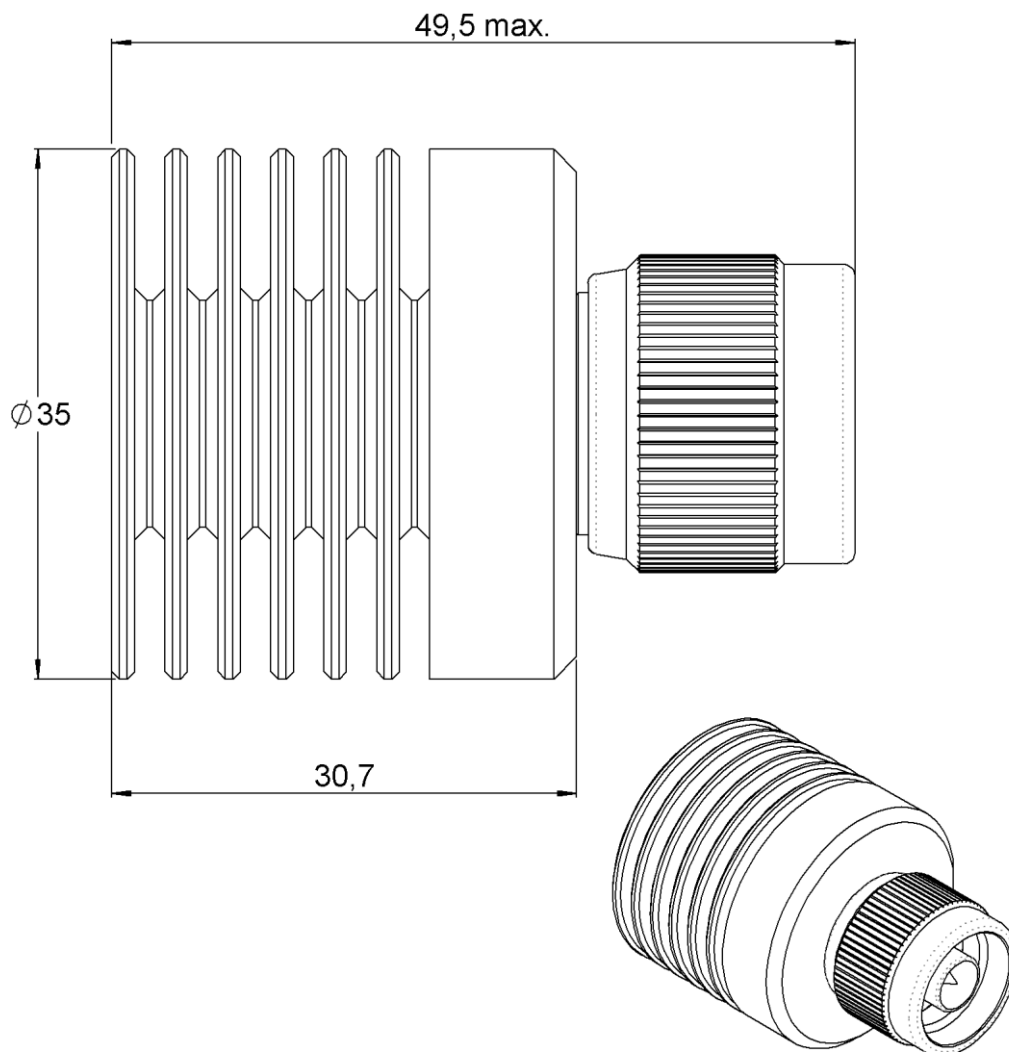

All dimensions are in mm. Tolerances according ISO 2768 m-H

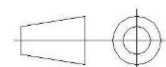

COMPONENTS	MATERIALS	PLATING (µm)
Body	BRASS	NICKEL 5
Center contact	BRASS	GOLD 2.5 OVER NICKEL 1
Outer contact	BRASS	NICKEL 5
Insulator	PTFE	
Gasket	SILICONE RUBBER	
Substrate	ALUMINA	
Resistor	THICK FILM	
Others parts	ALUMINIUM	BLACK ANODIZATION

PAGE 2/2	ISSUE 26-03-18A	SERIES CHARGE	PART NUMBER R404567000
----------	------------------------	-------------------------	-------------------------------

ELECTRICAL CHARACTERISTICS

Frequency (GHz)	DC - 4	4 - 8	8 - 12.4
V.S.W.R (≤)	1.10	1.20	1.30

Operating Frequency Range	DC - 12.4	GHz
Impedance	50	Ω
DC Resistance	50	Ω ± 5%
Peak power at 25°C (1μs, 1%)	4000	W
Average power at 25°C	12	W (Free Air Cooled)
		W (Conduction Cooled)

MECHANICAL CHARACTERISTICS

Connectors	N	Male	MIL C 39012
Weight	83,0600 g		

ENVIRONMENTAL CHARACTERISTICS

Operating temperature range	-55/+125	°C
Storage temperature range	-55/+125	°C

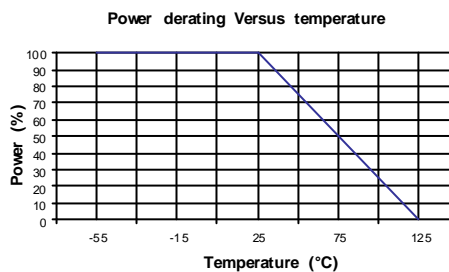

SPECIFICATION

OTHER CHARACTERISTICS