

# NCP508

## Very Low Noise, Fast Turn On, 50 mA Low Dropout Voltage Regulator

The NCP508 is a 50 mA low noise voltage regulator, designed to exhibit fast turn on time and high ripple rejection. Each device contains a voltage reference unit, an error amplifier, a PMOS power transistor, resistors for setting output voltage, current limit, and temperature limit protection circuits.

The NCP508 has been designed for use with ceramic capacitors. The device is housed in SC-88A and WDFN6 1.5x1.5 packages. Standard voltage versions are 1.5, 1.8, 2.5, 2.8, 3.0, and 3.3. Other voltages are available in 100 mV steps.

### Features

- Very Low Noise at 39  $\mu$ Vrms without a Bypass Capacitor
- High Ripple Rejection of 70 dB at 1 kHz
- Low Dropout Voltage of 140 mV (typ) at 30 mA
- Tight Load Regulation, typically 6 mV for  $\Delta I_{out} = 50$  mA
- Fast Enable Turn-On time of 20  $\mu$ sec
- Logic Level Enable
- ESR can vary from a few m $\Omega$  to 3  $\Omega$
- These are Pb-Free Devices

### Typical Applications

- RF Subsystems in Handsets
- Noise Sensitive Circuits; VCOs, PLL

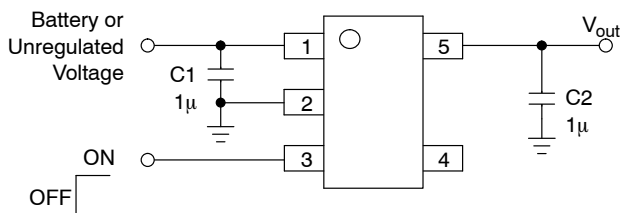
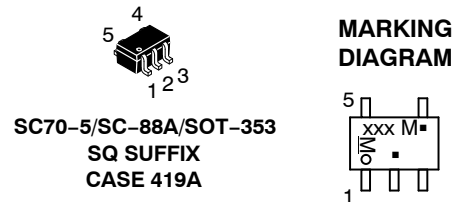

Figure 1. Typical Application Diagram



ON Semiconductor®

<http://onsemi.com>



XXX = Specific Device Code  
M = Date Code\*  
▪ = Pb-Free Package

(Note: Microdot may be in either location)

\*Date Code orientation and/or position may vary depending upon manufacturing location.

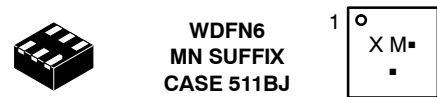

X = Specific Device Code  
M = Date Code  
▪ = Pb-Free Package

(Note: Microdot may be in either location)

### PIN CONNECTIONS

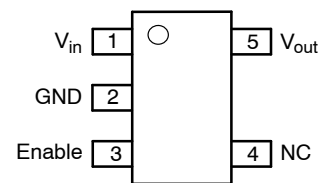

SC-88A  
(Top View)

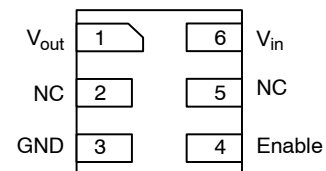

WDFN6  
(Top View)

### ORDERING INFORMATION

See detailed ordering and shipping information in the package dimensions section on page 13 of this data sheet.

# NCP508

## PIN FUNCTION DESCRIPTION

Pin No.	Pin Name	Description
1	V <sub>in</sub>	Positive power supply input voltage
2	GND	Power supply ground
3	Enable	This input is used to place the device into low-power stand by. When this input is pulled low, the device is disabled. If this function is not used, Enable should be connected to V <sub>in</sub> .
4	N/C	Not connected pin
5	V <sub>out</sub>	Regulated output voltage

## MAXIMUM RATING

Rating	Symbol	Value	Unit
Input Voltage	V <sub>in(max)</sub>	13.0	V
Enable Voltage	Enable	-0.3 to V <sub>in(max)</sub> + 0.3	V
Output Voltage	V <sub>out</sub>	-0.3 to V <sub>in(max)</sub> + 0.3	V
Power Dissipation and Thermal Characteristics (SC-88A) Power Dissipation Thermal Resistance, Junction-to-Ambient (Note 4)	P <sub>D</sub> R <sub>θJA</sub>	Internally Limited 200	W °C/W
Power Dissipation and Thermal Characteristics (WDFN6) Power Dissipation Thermal Resistance, Junction-to-Ambient (Note 4)	P <sub>D</sub> R <sub>θJA</sub>	Internally Limited 313	W °C/W
Maximum Junction Temperature	T <sub>J</sub>	+125	°C
Operating Ambient Temperature	T <sub>A</sub>	-40 to +85	°C
Storage Temperature	T <sub>stg</sub>	-55 to +150	°C
Lead Soldering Temperature @ 260°C	T <sub>solder</sub>	10	sec

Stresses exceeding Maximum Ratings may damage the device. Maximum Ratings are stress ratings only. Functional operation above the Recommended Operating Conditions is not implied. Extended exposure to stresses above the Recommended Operating Conditions may affect device reliability.

- This device series contains ESD protection and exceeds the following tests:  
Human Body Model 2000 V per MIL-STD-883, Method 3015.  
Machine Model Method 200 V
- Latch up Capability (85°C) ± 100 mA DC with trigger voltage
- Maximum package power dissipation limits must be observed.

$$P_D = \frac{T_{J(max)} - T_A}{R_{\theta JA}}$$

- R<sub>θJA</sub> on a 30 x 30 mm PCB Cu thickness 1 oz; T<sub>A</sub> = 25°C.

## RECOMMENDED OPERATING CONDITIONS

Rating	Symbol	Max	Unit
Maximum Operating Input Voltage	V <sub>in</sub>	7.0	V

# NCP508

**ELECTRICAL CHARACTERISTICS** ( $V_{in} = V_{out(nom)} + 1.0\text{ V}$ ,  $V_{enable} = V_{in}$ ,  $C_{in} = 1.0\ \mu\text{F}$ ,  $C_{out} = 1.0\ \mu\text{F}$ ,  $T_J = 25^\circ\text{C}$ , unless otherwise noted)

Characteristic	Symbol	Min	Typ	Max	Unit
Output Voltage Tolerance ( $T_A = 25^\circ\text{C}$ , $I_{out} = 10\text{ mA}$ )	$V_{out}$	-2	-	+2	%
Output Voltage Tolerance ( $T_A = -40^\circ\text{C}$ to $85^\circ\text{C}$ , $I_{out} = 10\text{ mA}$ )	$V_{out}$	-3	-	+3	%
Line Regulation ( $V_{in} = V_{out} + 1\text{ V}$ to $12\text{ V}$ , $I_{out} = 10\text{ mA}$ ) (Note 5)	$Reg_{line}$	-	2	20	mV
Load Regulation ( $I_{out} = 1.0\text{ mA}$ to $50\text{ mA}$ ) (Note 5)	$Reg_{load}$	-	6	40	mV
Output Current ( $V_{out} = V_{out(nom)} - 0.1\text{ V}$ )	$I_{out(nom)}$	50	-	-	mA
Dropout Voltage ( $V_{out} = 3.0\text{ V}$ , Measured at $V_{out} - 100\text{ mV}$ ) $I_{out} = 30\text{ mA}$ $I_{out} = 40\text{ mA}$ $I_{out} = 50\text{ mA}$	$V_{in} - V_{out}$	-	140 155 180	250 300 -	mV
Quiescent Current (Enable Input = $0\text{ V}$ )	$I_Q$	-	0.1	1	$\mu\text{A}$
Ground Current (Enable Input = $V_{in}$ , $V_{in} = V_{out} + 1\text{ V}$ , $I_{out} = 0\text{ mA}$ ) (Enable Input = $V_{in}$ , $I_{out} = 1\text{ mA}$ ) (Enable Input = $V_{in}$ , $I_{out} = 10\text{ mA}$ ) (Enable Input = $V_{in}$ , $I_{out} = 50\text{ mA}$ )	$I_{GND}$	-	145 160 300 1100	200 260 500 1900	$\mu\text{A}$
Enable Input Threshold Voltage (Voltage Increasing, Output Turns On, Logic High) (Voltage Decreasing, Output Turns Off, Logic Low)	$V_{th(en)}$	0.9 -	- -	- 0.15	V
Enable Input Current ( $V_{enable} = 2.4\text{ V}$ )	$I_{enable}$	-	8.0	15	$\mu\text{A}$
Output Turn On Time (Note 6)	-	-	20	-	$\mu\text{s}$
Output Short Circuit Current Limit ( $V_{out} = 0\text{ V}$ )	$I_{out(max)}$	100	250	-	mA
Ripple Rejection ( $V_{in} = V_{out(nom)} + 1\text{ Vdc} + 0.5\text{ V}_{pp}$ , $f = 1\text{ kHz}$ , $I_o = 10\text{ mA}$ )	RR	-	70	-	dB
Output Noise Voltage ( $f = 100\text{ Hz}$ to $100\text{ kHz}$ ) ( $V_{out} = 1.5\text{ V}$ )	$V_n$	-	39	-	$\mu\text{V}_{rms}$

5. Low duty cycle pulse techniques are used during testing to maintain the junction temperature as close to ambient as possible.
6. Turn on time is defined from Enable at 10% to  $V_{out}$  at 95% nominal value. Min and max values  $T_A = -40^\circ\text{C}$  to  $85^\circ\text{C}$ ,  $T_{jmax} = 125^\circ\text{C}$ .  $V_{enable} = 0\text{ V}$  to  $V_{in}$ .  $C_{out} = 1.0\ \mu\text{F}$ .

TYPICAL CHARACTERISTICS

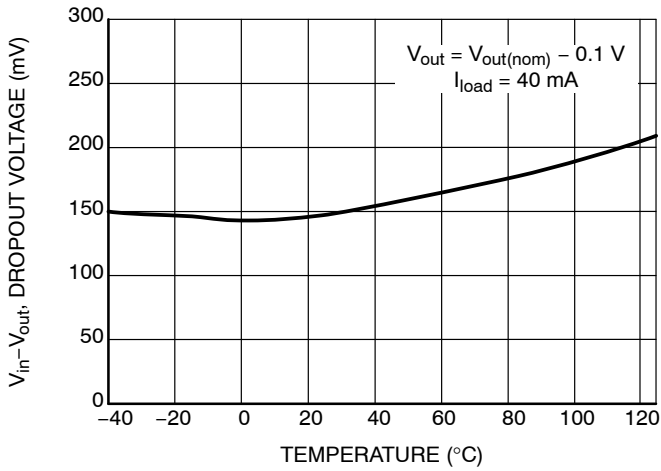

Figure 2. Dropout Voltage vs. Temperature, 1.5 V

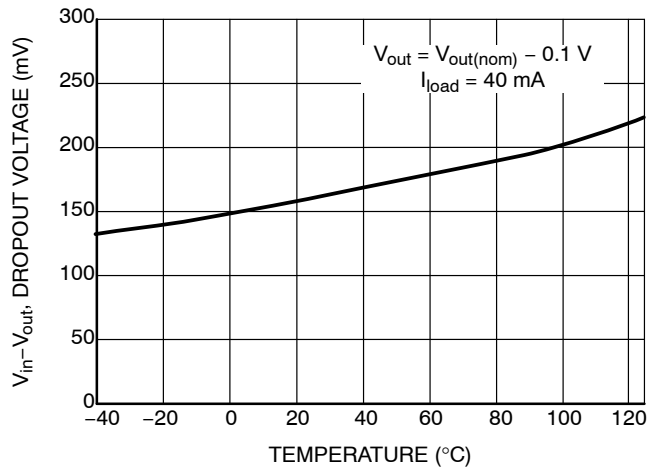

Figure 3. Dropout Voltage vs. Temperature, 3.3 V

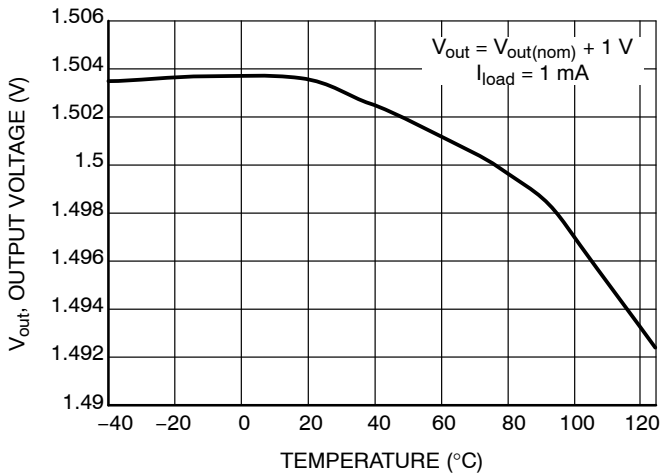

Figure 4. Output Voltage vs. Temperature, 1.5 V

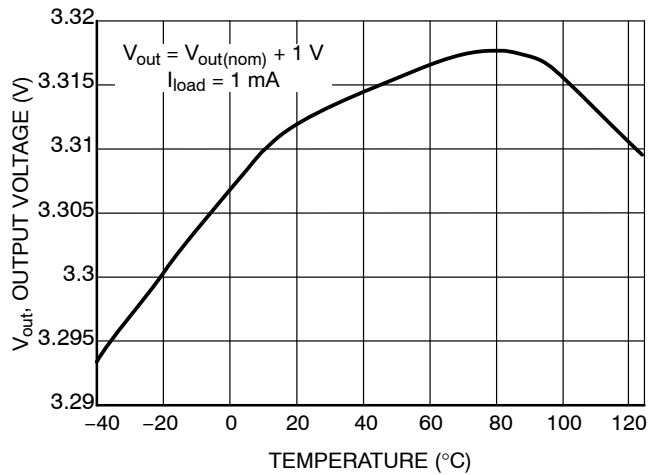

Figure 5. Output Voltage vs. Temperature, 3.3 V

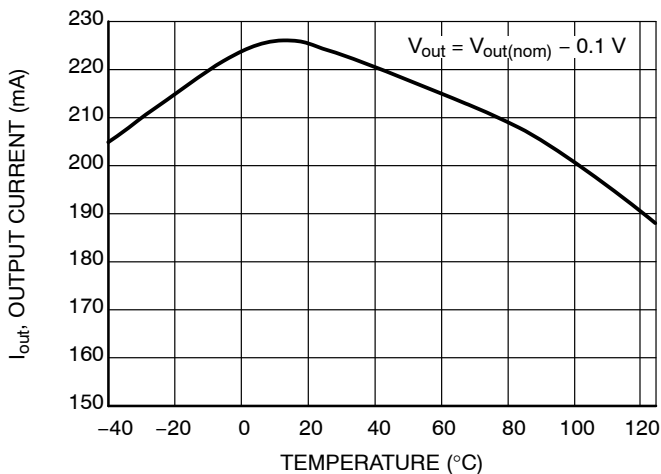

Figure 6. Output Current Limit vs. Temperature, 1.5 V

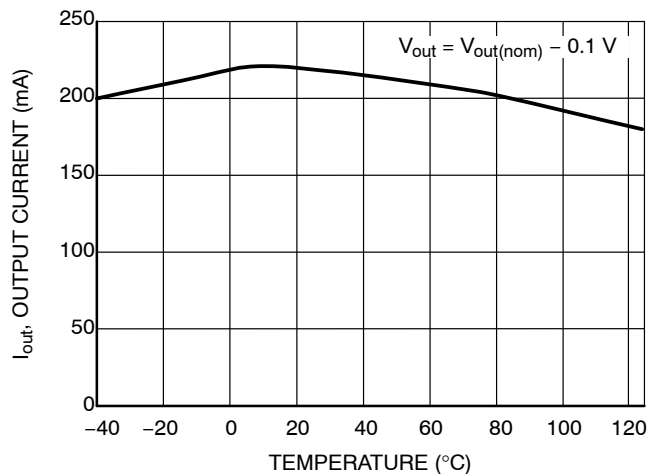
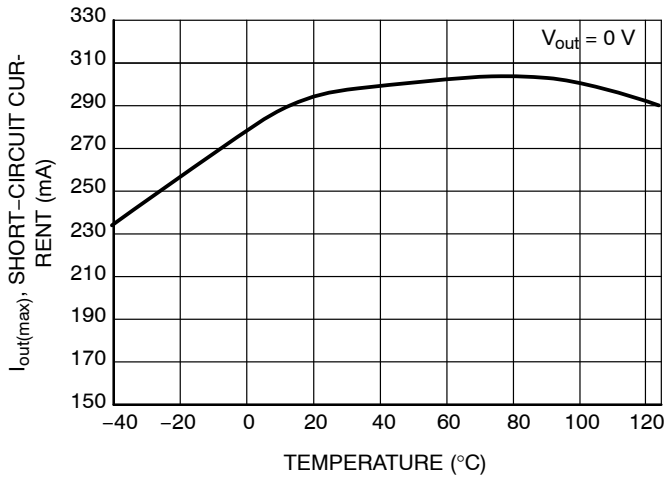

Figure 7. Output Current Limit vs. Temperature, 3.3 V

# NCP508

## TYPICAL CHARACTERISTICS



**Figure 8. Short-Circuit Current Limit vs. Temperature, 1.5 V**

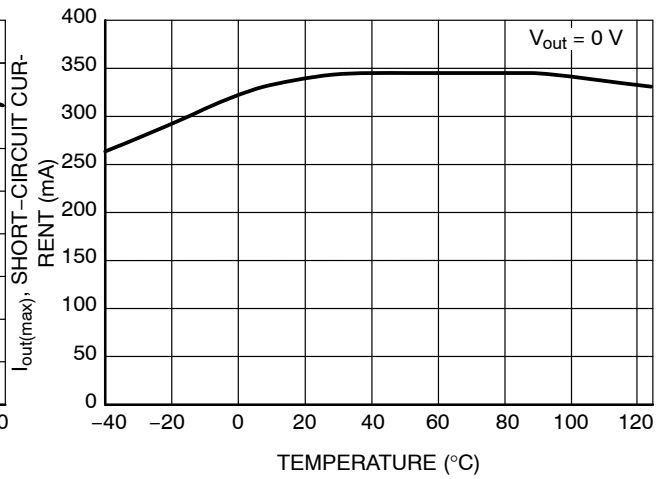

**Figure 9. Short-Circuit Current Limit vs. Temperature, 3.3 V**

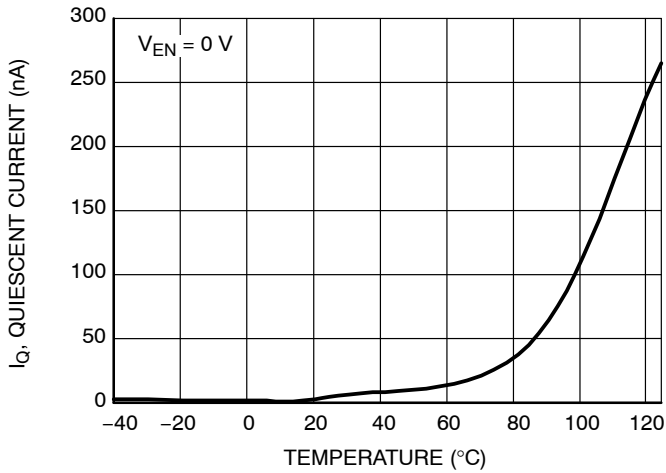

**Figure 10. Quiescent Current vs. Temperature, 1.5 V**

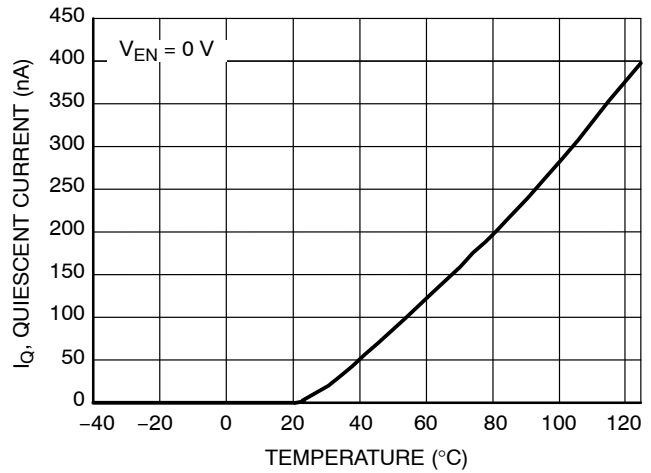

**Figure 11. Quiescent Current vs. Temperature, 3.3 V**

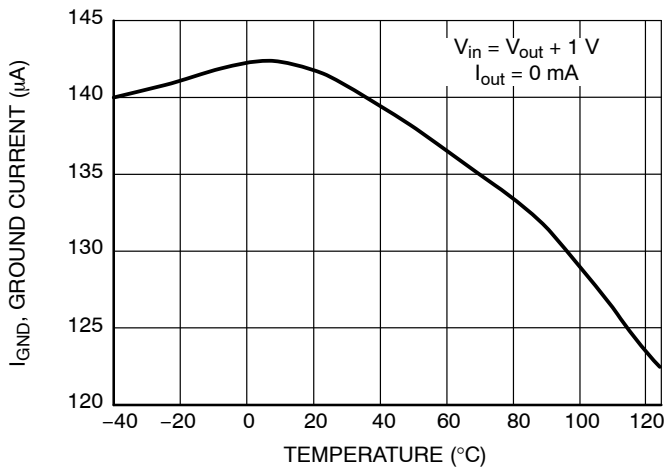

**Figure 12. Ground Current vs. Temperature, 1.5 V**

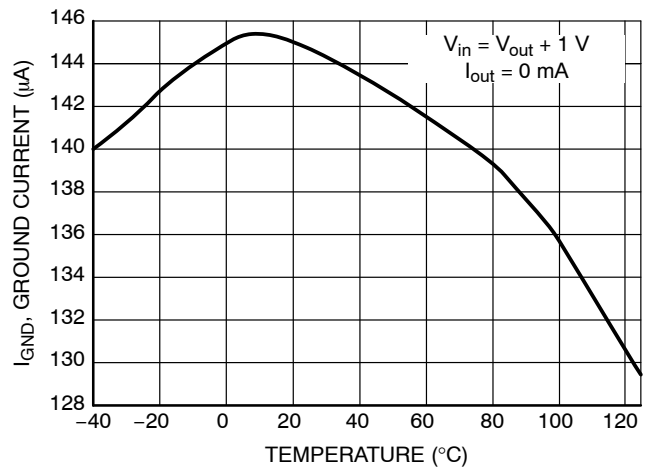

**Figure 13. Ground Current vs. Temperature, 3.3 V**

# NCP508

## TYPICAL CHARACTERISTICS

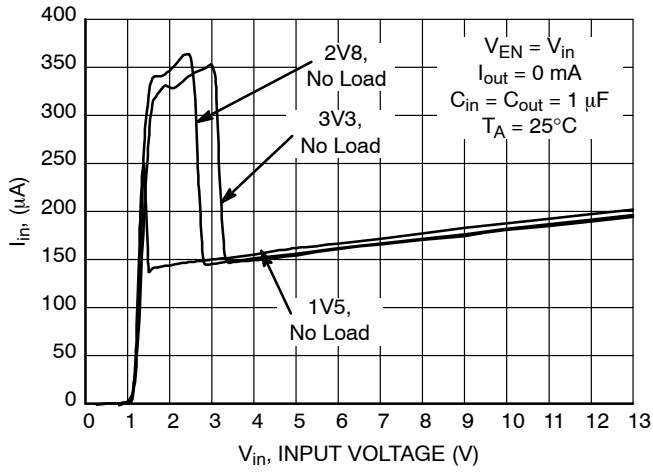

Figure 14. Quiescent Current vs. Input Voltage

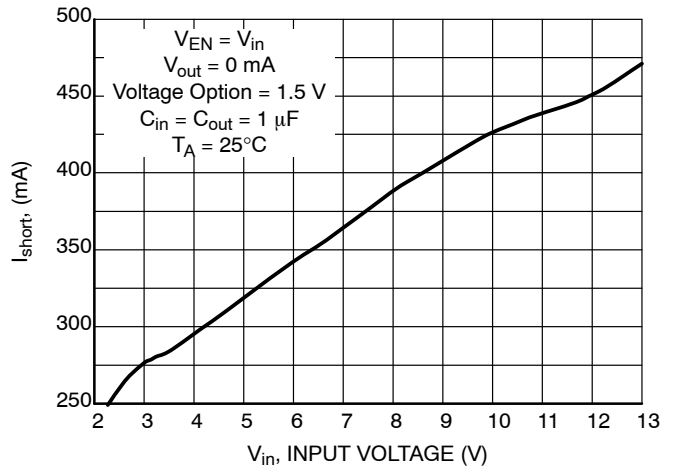

Figure 15. Output Short-Circuit Current vs. Input Voltage

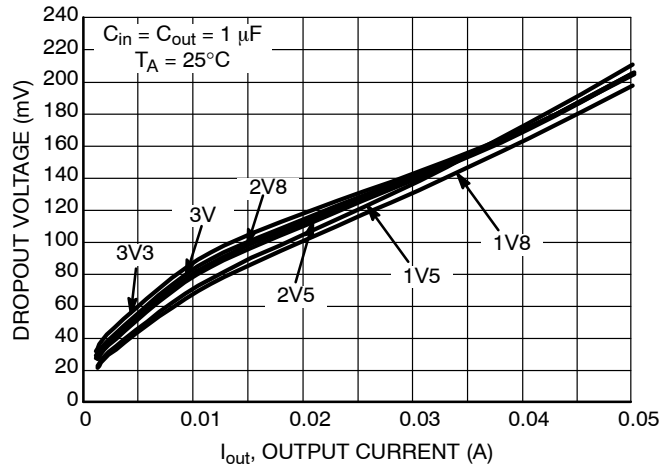

Figure 16. Dropout Voltage vs. Output Current

TYPICAL CHARACTERISTICS

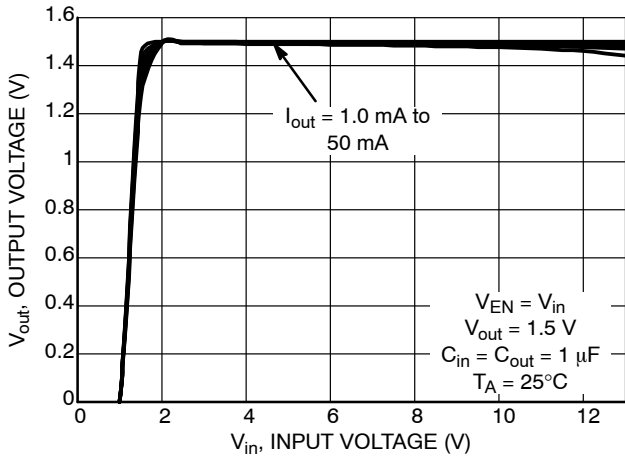

Figure 17. Output Voltage vs. Input Voltage

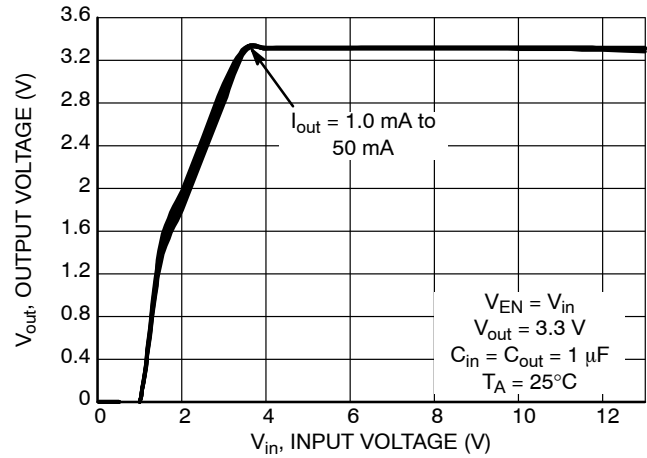

Figure 18. Output Voltage vs. Input Voltage

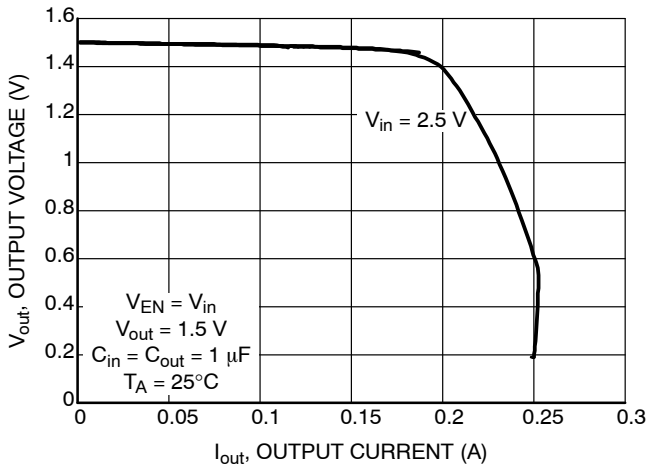

Figure 19. Output Voltage vs. Output Current

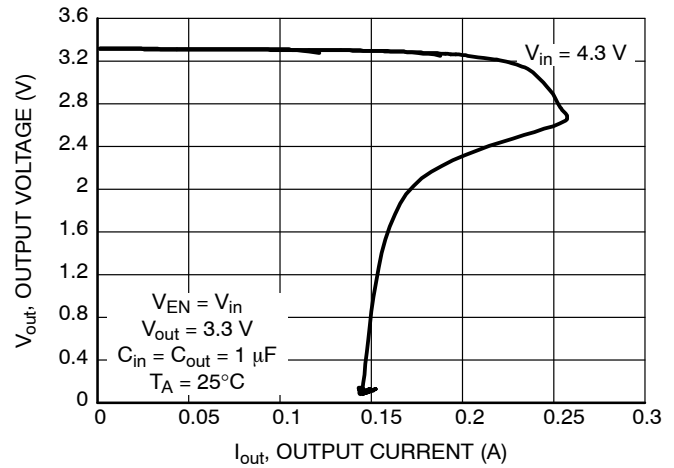

Figure 20. Output Voltage vs. Output Current

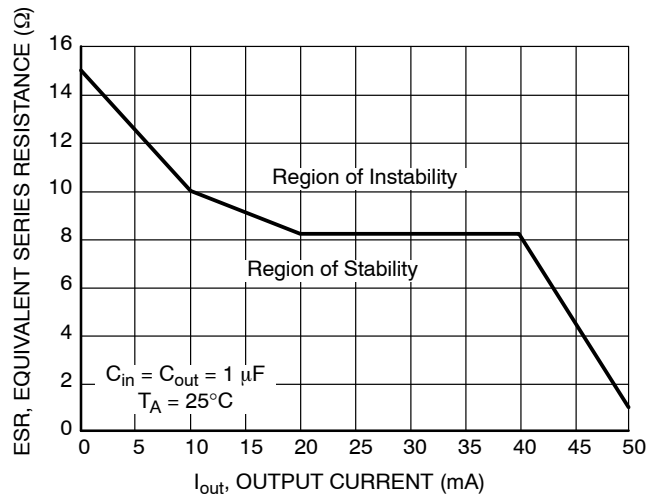
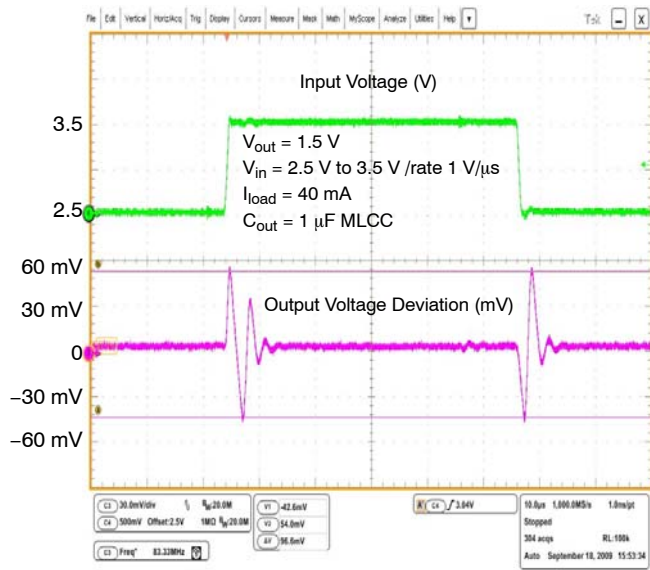

Figure 21. Equivalent Series Resistance vs. Output Current, X7R, MLCC Capacitor

# NCP508

## TYPICAL CHARACTERISTICS



**Figure 22. Line Transient Response  
1.5 V/40 mA**

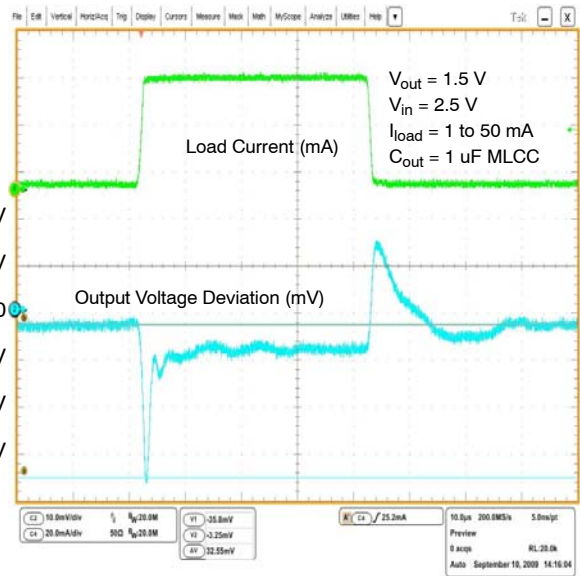

**Figure 23. Load Transient Response 1.5 V**

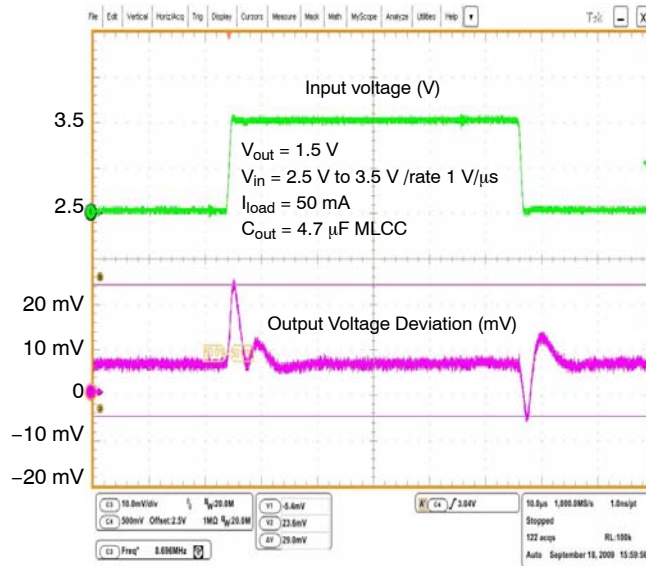

**Figure 24. Line Transient Response  
1.5 V/50 mA**



# NCP508

## TYPICAL CHARACTERISTICS

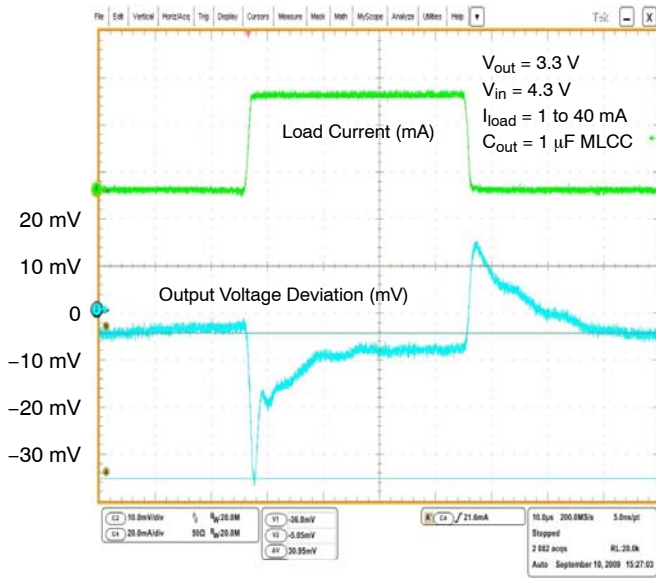

Figure 25. Load Transient Response 3.3 V

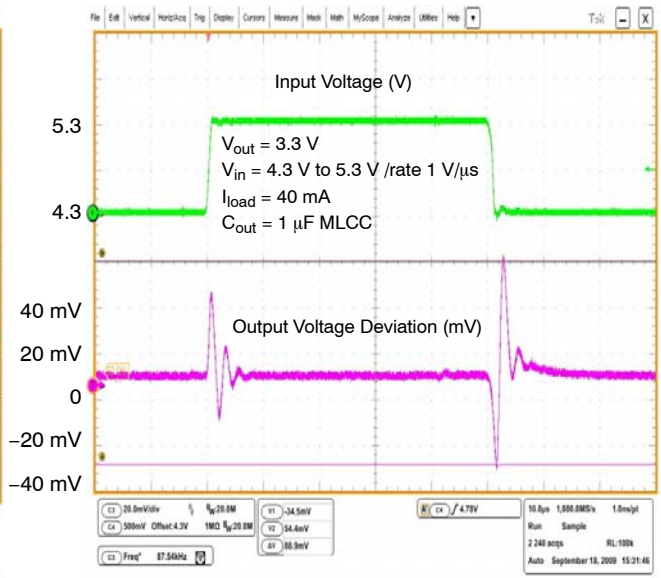

Figure 26. Line Transient Response  
3.3 V/40 mA

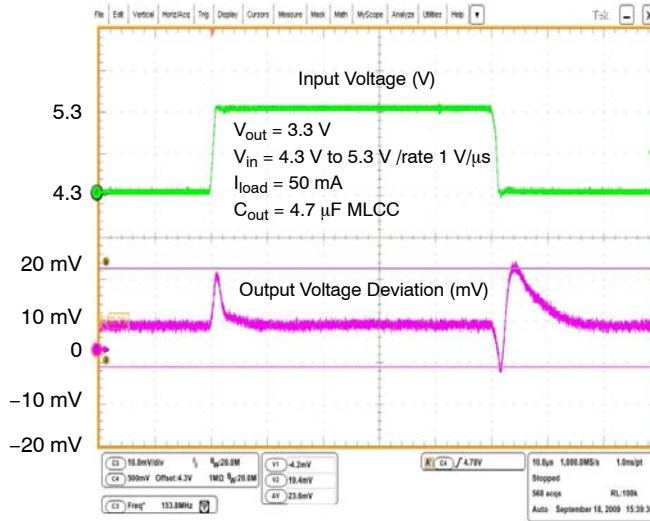
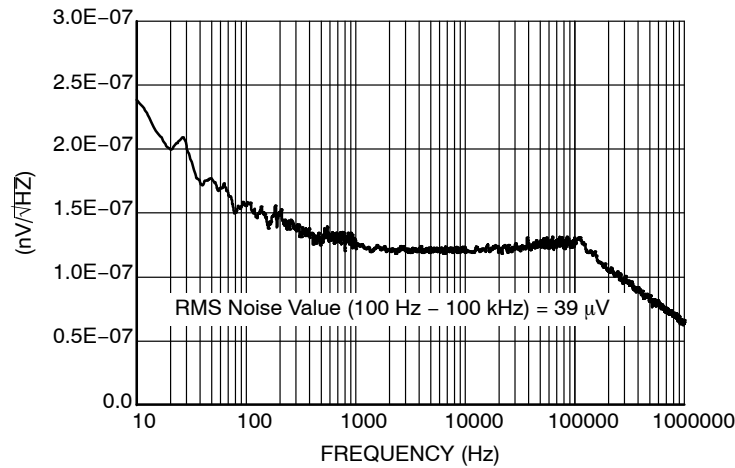

Figure 27. Line Transient Response  
3.3 V/50 mA

# NCP508

## TYPICAL CHARACTERISTICS



**Figure 28. Output Voltage Noise**  
 $V_{out} = 1.5\text{ V}$ ,  $I_{out} = 40\text{ mA}$

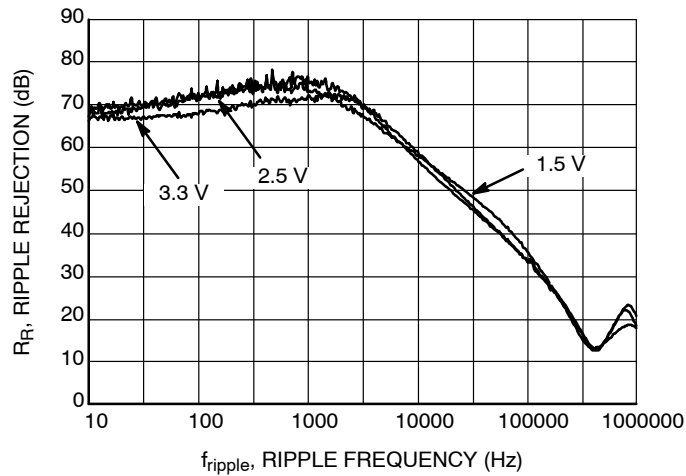

**Figure 29. Ripple Rejection vs. Frequency**  
 $I_{out} = 40\text{ mA}$ ,  $0.5\text{ V}_{pp}$

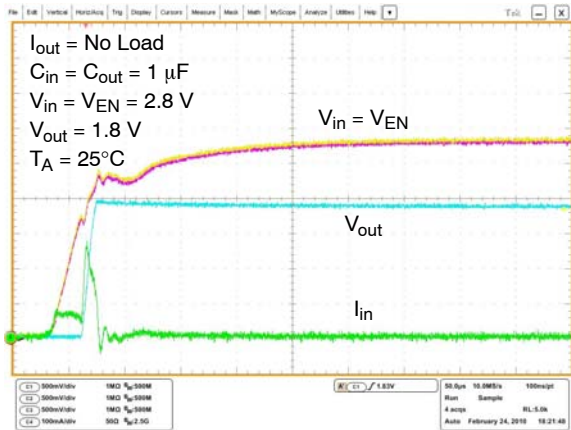

**Figure 30. Startup, No Load**

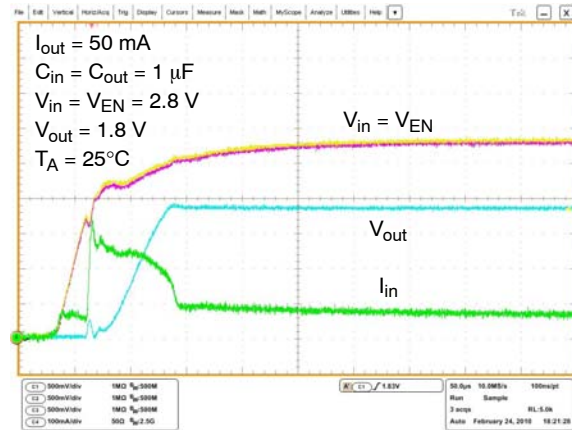

**Figure 31. Startup,  $I_{out} = 50\text{ mA}$**

# NCP508

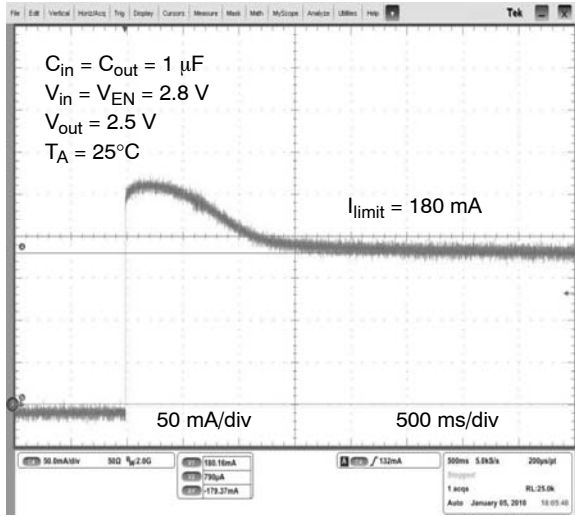

Figure 32. Hard Short-Circuit Current (by Copper Wires)

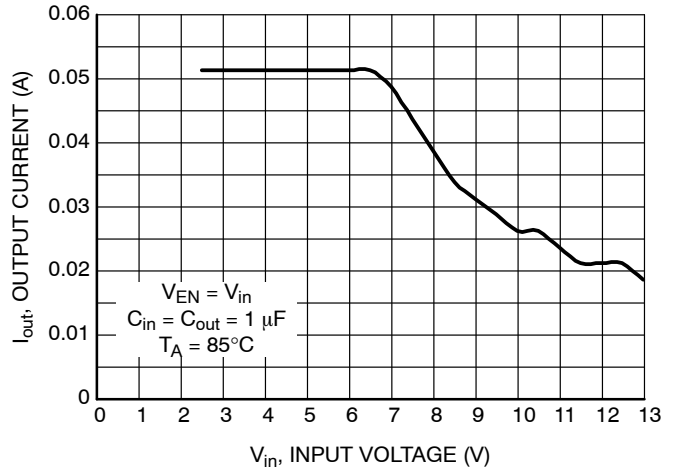

Figure 33. Measured Power Operating Area, 1.5 V,  $T_A = 85^\circ\text{C}$ ,  $V_{out\_drop} = \text{max } 0.1 \text{ V}$

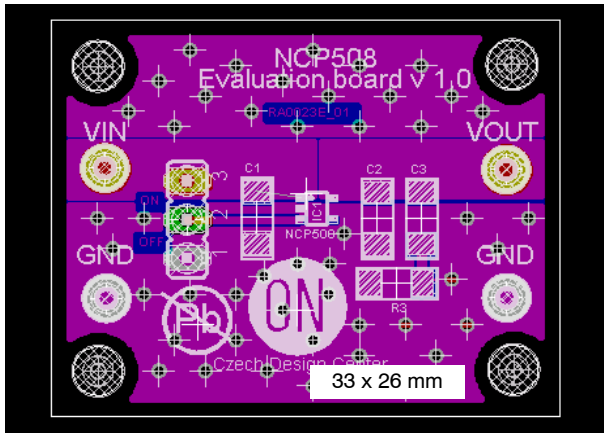

Figure 34. Evaluation Board

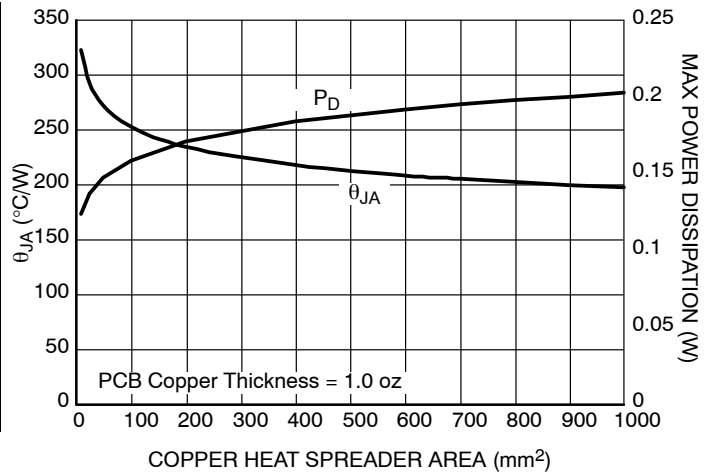

Figure 35. SC70-5 Thermal Resistance vs. Copper Heat Spreader Area

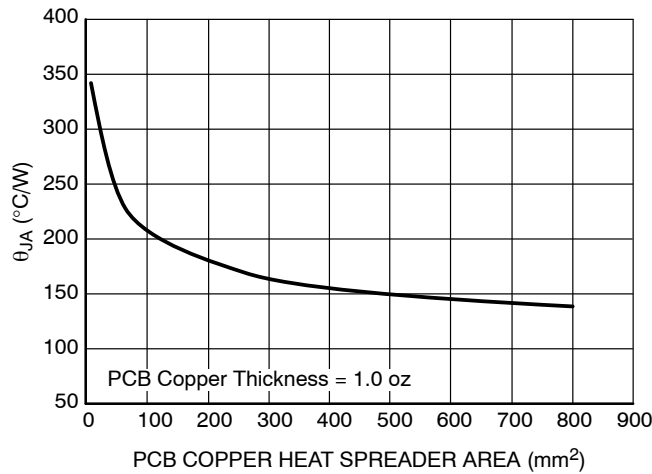

Figure 36. WDFN6 Thermal Resistance vs. Copper Heat Spreader Area

## DEFINITIONS

**Load Regulation**

The change in output voltage for a change in output current at a constant temperature.

**Dropout Voltage**

The input/output differential at which the regulator output no longer maintains regulation against further reductions in input voltage. Measured when the output drops 100 mV below its nominal. The junction temperature, load current, and minimum input supply requirements affect the dropout level.

**Maximum Power Dissipation**

The maximum total dissipation for which the regulator will operate within its specifications.

**Quiescent Current**

The quiescent current is the current which flows through the ground when the LDO operates without a load on its output: internal IC operation, bias, etc. When the LDO becomes loaded, this term is called the Ground current. It is actually the difference between the input current (measured through the LDO input pin) and the output current.

**Line Regulation**

The change in output voltage for a change in input voltage. The measurement is made under conditions of low dissipation or by using pulse technique such that the average chip temperature is not significantly affected.

**Line Transient Response**

Typical over and undershoot response when input voltage is excited with a given slope.

**Thermal Protection**

Internal thermal shutdown circuitry is provided to protect the integrated circuit in the event that the maximum junction temperature is exceeded. When activated at typically 125°C, the regulator turns off. This feature is provided to prevent failures from accidental overheating.

**Maximum Package Power Dissipation**

The maximum power package dissipation is the power dissipation level at which the junction temperature reaches its maximum operating value, i.e. 150°C. Depending on the ambient power dissipation and thus the maximum available output current.

## APPLICATIONS INFORMATION

Typical application circuit for the NCP508 series is shown in Figure 1.

**Input Decoupling (C1)**

An input capacitor of at least 1.0 μF, (ceramic or tantalum) is recommended to improve the transient response of the regulator and/or if the regulator is located more than a few inches from the power source. It will also reduce the circuit's sensitivity to the input line impedance at high frequencies. The capacitor should be mounted with the shortest possible track length directly across the regular's input terminals. Higher values and lower ESR will improve the overall line transient response.

**Output Decoupling (C2)**

The NCP508 is a stable regulator and does not require a minimum output current. Capacitors exhibiting ESRs ranging from a few mΩ up to 3 Ω can safely be used. The minimum decoupling value is 1.0 μF and can be augmented to fulfill stringent load transient requirements. The regulator accepts ceramic chip capacitors as well as tantalum devices. Larger values improve noise rejection and load regulation transient response.

**Enable Operation**

The enable pin will turn on or off the regulator. The limits of threshold are covered in the electrical specification section of this datasheet. If the enable is not used then the pin should be connected to  $V_{in}$ .

**Hints**

Please be sure the  $V_{in}$  and GND lines are sufficiently wide. When the impedance of these lines is high, there is a chance to pick up noise or cause the regulator to malfunction.

Set external components, especially the output capacitor, as close as possible to the circuit, and make leads as short as possible.

**Thermal Considerations**

Internal thermal limiting circuitry is provided to protect the integrated circuit in the event that the maximum junction temperature is exceeded.

The maximum power dissipation supported by the device is dependent upon board design and layout. Mounting pad configuration on the PCB, the board material and also the ambient temperature effect the rate of temperature rise for the part. This is stating that when the NCP508 has good thermal conductivity through the PCB, the junction temperature will be relatively low with high power dissipation applications.

The maximum dissipation the package can handle is given by:

$$P_D = \frac{T_{J(max)} - T_A}{R_{\theta JA}} \quad (\text{eq. 1})$$

where:

- $T_{J(max)}$  is the maximum allowable junction temperature of the die, which is 150°C
- $T_A$  is the ambient operating temperature
- $R_{\theta ja}$  is dependent on the surrounding PCB layout

# NCP508

## ORDERING INFORMATION

Device	Nominal Output Voltage	Marking	Package	Shipping†
NCP508SQ15T1G	1.5	D5A	SC-88A (Pb-Free)	3000 / Tape & Reel
NCP508SQ18T1G	1.8	D5C	SC-88A (Pb-Free)	3000 / Tape & Reel
NCP508SQ25T1G	2.5	D5D	SC-88A (Pb-Free)	3000 / Tape & Reel
NCP508SQ28T1G	2.8	D5E	SC-88A (Pb-Free)	3000 / Tape & Reel
NCP508SQ30T1G	3.0	D5F	SC-88A (Pb-Free)	3000 / Tape & Reel
NCP508SQ33T1G	3.3	D5G	SC-88A (Pb-Free)	3000 / Tape & Reel
NCP508MT15TBG	1.5	B	WDFN6 (Pb-Free)	3000 / Tape & Reel
NCP508MT18TBG	1.8	A	WDFN6 (Pb-Free)	3000 / Tape & Reel
NCP508MT25TBG	2.5	C	WDFN6 (Pb-Free)	3000 / Tape & Reel
NCP508MT28TBG	2.8	D	WDFN6 (Pb-Free)	3000 / Tape & Reel
NCP508MT30TBG	3.0	E	WDFN6 (Pb-Free)	3000 / Tape & Reel
NCP508MT33TBG	3.3	F	WDFN6 (Pb-Free)	3000 / Tape & Reel

†For information on tape and reel specifications, including part orientation and tape sizes, please refer to our Tape and Reel Packaging Specifications Brochure, BRD8011/D.

NOTE: Additional voltages in 100 mV steps are available upon request by contacting your ON Semiconductor representative.

# MECHANICAL CASE OUTLINE PACKAGE DIMENSIONS



SCALE 2:1

## SC-88A (SC-70-5/SOT-353) CASE 419A-02 ISSUE M

DATE 11 APR 2023

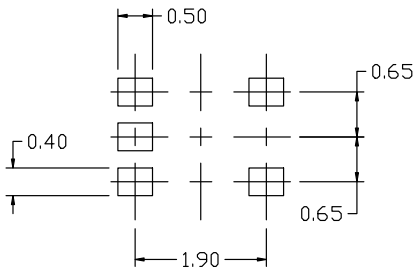
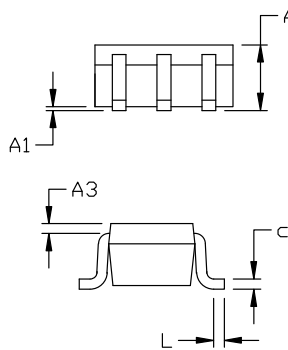
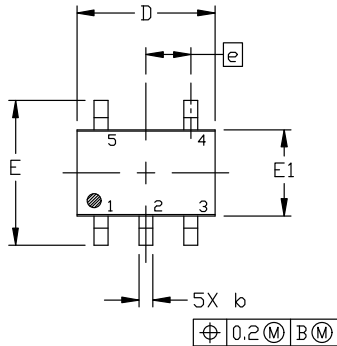

RECOMMENDED  
MOUNTING FOOTPRINT

\* For additional information on our Pb-Free strategy and soldering details, please download the ON Semiconductor Soldering and Mounting Techniques Reference Manual, SOLDERM/D.

### NOTES:

1. DIMENSIONING AND TOLERANCING PER ANSI Y14.5M, 1982.
2. CONTROLLING DIMENSION: MILLIMETERS
3. 419A-01 OBSOLETE. NEW STANDARD 419A-02
4. DIMENSIONS D AND E1 DO NOT INCLUDE MOLD FLASH, PROTRUSIONS, OR GATE BURRS. MOLD FLASH, PROTRUSIONS, OR GATE BURRS SHALL NOT EXCEED 0.1016MM PER SIDE.

DIM	MILLIMETERS		
	MIN.	NOM.	MAX.
A	0.80	0.95	1.10
A1	---	---	0.10
A3	0.20 REF		
b	0.10	0.20	0.30
c	0.10	---	0.25
D	1.80	2.00	2.20
E	2.00	2.10	2.20
E1	1.15	1.25	1.35
e	0.65 BSC		
L	0.10	0.15	0.30

### GENERIC MARKING DIAGRAM\*

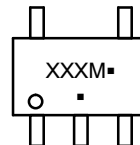

\*This information is generic. Please refer to device data sheet for actual part marking. Pb-Free indicator, "G" or microdot "▪", may or may not be present. Some products may not follow the Generic Marking.

XXX = Specific Device Code

M = Date Code

▪ = Pb-Free Package

(Note: Microdot may be in either location)

#### STYLE 1:

1. BASE
2. EMITTER
3. BASE
4. COLLECTOR
5. COLLECTOR

#### STYLE 2:

1. ANODE
2. EMITTER
3. BASE
4. COLLECTOR
5. CATHODE

#### STYLE 3:

1. ANODE 1
2. N/C
3. ANODE 2
4. CATHODE 2
5. CATHODE 1

#### STYLE 4:

1. SOURCE 1
2. DRAIN 1/2
3. SOURCE 1
4. GATE 1
5. GATE 2

#### STYLE 5:

1. CATHODE
2. COMMON ANODE
3. CATHODE 2
4. CATHODE 3
5. CATHODE 4

#### STYLE 6:

1. EMITTER 2
2. BASE 2
3. EMITTER 1
4. COLLECTOR
5. COLLECTOR 2/BASE 1

#### STYLE 7:

1. BASE
2. EMITTER
3. BASE
4. COLLECTOR
5. COLLECTOR

#### STYLE 8:

1. CATHODE
2. COLLECTOR
3. N/C
4. BASE
5. EMITTER

#### STYLE 9:

1. ANODE
2. CATHODE
3. ANODE
4. ANODE
5. ANODE

Note: Please refer to datasheet for style callout. If style type is not called out in the datasheet refer to the device datasheet pinout or pin assignment.

<b>DOCUMENT NUMBER:</b>	<b>98ASB42984B</b>	Electronic versions are uncontrolled except when accessed directly from the Document Repository. Printed versions are uncontrolled except when stamped "CONTROLLED COPY" in red.
<b>DESCRIPTION:</b>	<b>SC-88A (SC-70-5/SOT-353)</b>	<b>PAGE 1 OF 1</b>

onsemi and ONSEMI are trademarks of Semiconductor Components Industries, LLC dba onsemi or its subsidiaries in the United States and/or other countries. onsemi reserves the right to make changes without further notice to any products herein. onsemi makes no warranty, representation or guarantee regarding the suitability of its products for any particular purpose, nor does onsemi assume any liability arising out of the application or use of any product or circuit, and specifically disclaims any and all liability, including without limitation special, consequential or incidental damages. onsemi does not convey any license under its patent rights nor the rights of others.

# MECHANICAL CASE OUTLINE

## PACKAGE DIMENSIONS

ON Semiconductor®



SCALE 4:1

WDFN6 1.5x1.5, 0.5P  
CASE 511BJ  
ISSUE C

DATE 06 OCT 2015

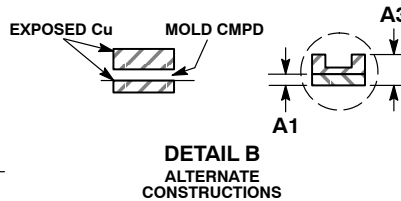
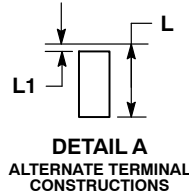
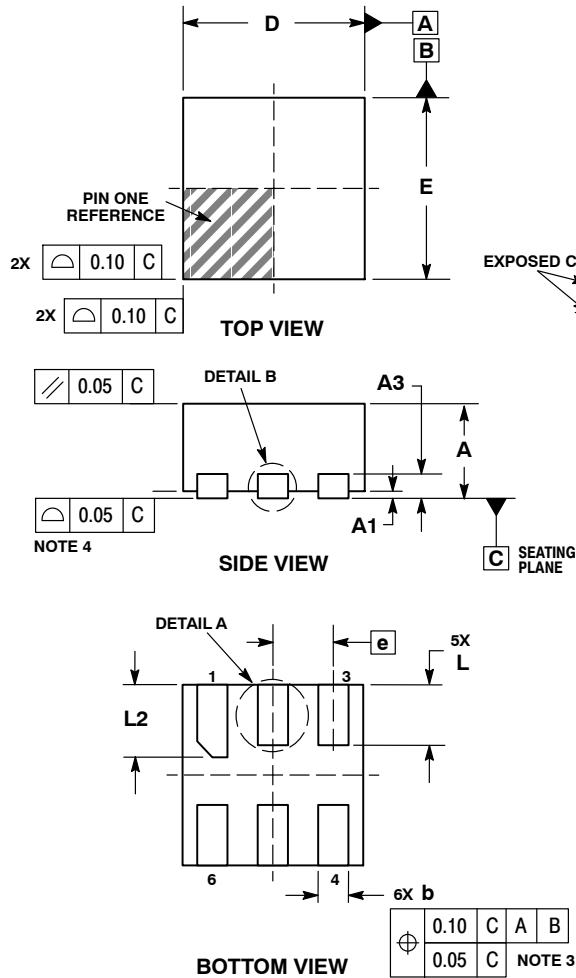

- NOTES:
1. DIMENSIONING AND TOLERANCING PER ASME Y14.5M, 1994.
  2. CONTROLLING DIMENSION: MILLIMETERS.
  3. DIMENSION b APPLIES TO PLATED TERMINAL AND IS MEASURED BETWEEN 0.15 AND 0.30mm FROM TERMINAL TIP.
  4. COPLANARITY APPLIES TO THE EXPOSED PAD AS WELL AS THE TERMINALS.

DIM	MILLIMETERS	
	MIN	MAX
A	0.70	0.80
A1	0.00	0.05
A3	0.20 REF	
b	0.20	0.30
D	1.50 BSC	
E	1.50 BSC	
e	0.50 BSC	
L	0.40	0.60
L1	---	0.15
L2	0.50	0.70

### GENERIC MARKING DIAGRAM\*

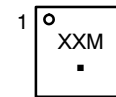

- XX = Specific Device Code
- M = Date Code
- = Pb-Free Package

\*This information is generic. Please refer to device data sheet for actual part marking. Pb-Free indicator, "G" or microdot "▪", may or may not be present.

### RECOMMENDED MOUNTING FOOTPRINT\*

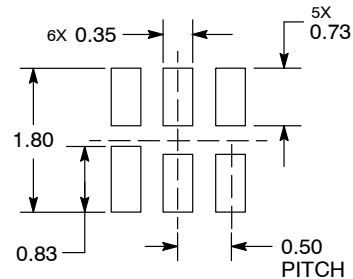

DIMENSIONS: MILLIMETERS

\*For additional information on our Pb-Free strategy and soldering details, please download the ON Semiconductor Soldering and Mounting Techniques Reference Manual, SOLDERRM/D.

<b>DOCUMENT NUMBER:</b>	<b>98AON50296E</b>	Electronic versions are uncontrolled except when accessed directly from the Document Repository. Printed versions are uncontrolled except when stamped "CONTROLLED COPY" in red.
<b>DESCRIPTION:</b>	<b>WDFN6, 1.5 X 1.5, 0.5 P</b>	<b>PAGE 1 OF 1</b>

ON Semiconductor and ON are trademarks of Semiconductor Components Industries, LLC dba ON Semiconductor or its subsidiaries in the United States and/or other countries. ON Semiconductor reserves the right to make changes without further notice to any products herein. ON Semiconductor makes no warranty, representation or guarantee regarding the suitability of its products for any particular purpose, nor does ON Semiconductor assume any liability arising out of the application or use of any product or circuit, and specifically disclaims any and all liability, including without limitation special, consequential or incidental damages. ON Semiconductor does not convey any license under its patent rights nor the rights of others.

**onsemi**, **Onsemi**, and other names, marks, and brands are registered and/or common law trademarks of Semiconductor Components Industries, LLC dba "**onsemi**" or its affiliates and/or subsidiaries in the United States and/or other countries. **onsemi** owns the rights to a number of patents, trademarks, copyrights, trade secrets, and other intellectual property. A listing of **onsemi**'s product/patent coverage may be accessed at [www.onsemi.com/site/pdf/Patent-Marking.pdf](http://www.onsemi.com/site/pdf/Patent-Marking.pdf). **onsemi** reserves the right to make changes at any time to any products or information herein, without notice. The information herein is provided "as-is" and **onsemi** makes no warranty, representation or guarantee regarding the accuracy of the information, product features, availability, functionality, or suitability of its products for any particular purpose, nor does **onsemi** assume any liability arising out of the application or use of any product or circuit, and specifically disclaims any and all liability, including without limitation special, consequential or incidental damages. Buyer is responsible for its products and applications using **onsemi** products, including compliance with all laws, regulations and safety requirements or standards, regardless of any support or applications information provided by **onsemi**. "Typical" parameters which may be provided in **onsemi** data sheets and/or specifications can and do vary in different applications and actual performance may vary over time. All operating parameters, including "Typicals" must be validated for each customer application by customer's technical experts. **onsemi** does not convey any license under any of its intellectual property rights nor the rights of others. **onsemi** products are not designed, intended, or authorized for use as a critical component in life support systems or any FDA Class 3 medical devices or medical devices with a same or similar classification in a foreign jurisdiction or any devices intended for implantation in the human body. Should Buyer purchase or use **onsemi** products for any such unintended or unauthorized application, Buyer shall indemnify and hold **onsemi** and its officers, employees, subsidiaries, affiliates, and distributors harmless against all claims, costs, damages, and expenses, and reasonable attorney fees arising out of, directly or indirectly, any claim of personal injury or death associated with such unintended or unauthorized use, even if such claim alleges that **onsemi** was negligent regarding the design or manufacture of the part. **onsemi** is an Equal Opportunity/Affirmative Action Employer. This literature is subject to all applicable copyright laws and is not for resale in any manner.

## PUBLICATION ORDERING INFORMATION

### LITERATURE FULFILLMENT:

Email Requests to: [orderlit@onsemi.com](mailto:orderlit@onsemi.com)

**onsemi Website:** [www.onsemi.com](http://www.onsemi.com)

### TECHNICAL SUPPORT

**North American Technical Support:**

Voice Mail: 1 800-282-9855 Toll Free USA/Canada

Phone: 011 421 33 790 2910

**Europe, Middle East and Africa Technical Support:**

Phone: 00421 33 790 2910

For additional information, please contact your local Sales Representative