

High Brightness SEPIC LED Driver Demoboard with High Dimming Ratio and Excellent Current Regulation

General Description

The HV9911DB4 is an LED driver demoboard capable of driving one to six three-watt LEDs in series from an input of 9.0 - 16VDC. The demoboard uses Supertex's HV9911 in a SEPIC topology to drive LED string voltages higher or lower than the input voltage. The converter has a very good initial regulation (+/-5%), and excellent line and load regulation over the entire input and output voltage range (<+/-1%). The full load efficiency of the converter is typically greater than 85%.

The HV9911DB4 is also protected against open LED and output short circuit conditions. It is protected against over load conditions by limiting the input current. It has an excellent PWM dimming response. The switching frequency of the HV9911DB4 can be synchronized to other HV9911 boards or to an external 350kHz clock by connecting the clock to the SYNC pin of the HV9911DB4.

Specifications

Parameter	Value
Input voltage (steady state):	9.0 - 16VDC
Output LED string voltage:	3V min - 24V max
Output current:	700mA +/-5%
Output current ripple:	5% typical
Switching frequency:	350kHz
Full load efficiency:	87% (at 13V input)
Open LED protection:	Shuts down at 30V
Output short circuit protection:	Included
Dimensions	56.0mm x 38.2mm

Board Layout and Connection Diagram



Actual Size: 56.0mm x 38.2mm

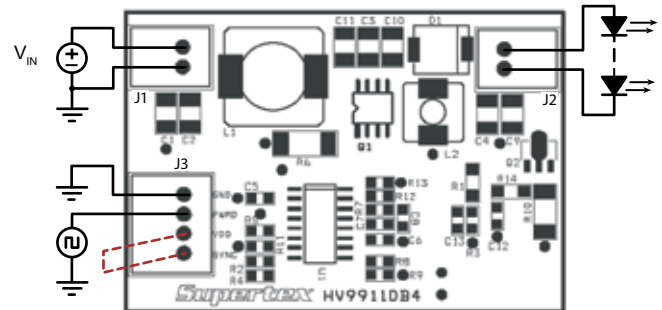

Connections:

Input - The input is connected between the terminals of connector J1 as shown in the connection diagram.

Output - The output is connected between the terminals of connector J2 as shown.

Enable/PWM Dimming - To enable the board, short pins PWMD and V_{DD} of connector J3 as shown. To use the PWM dimming feature of the board, connect an external push-pull square wave source between terminal PWMD and GND of connector J3 as shown by the dotted lines.

SYNC: To synchronize two or more boards, connect the SYNC pins of all the boards. To synchronize the HV9911DB4 to an external 350kHz clock, connect the clock between SYNC and GND pins of terminal J3.

Note:

During PWM dimming, V_{DD} of connector J3 should be left open. Also, the PWM signal must have the proper polarity with the positive connected to PWMD of J3. Note that GND of J3 is internally connected to the return path of the input voltage.

Demoboard Testing:

Normal Operation: Connect the input source and the output LEDs as shown in the connection diagram and enable the board. The LEDs will glow with a steady intensity. Connecting an ammeter in series with the LEDs will allow measurement of the LED current. The current will be 700mA +/- 5%.

Current Regulation: With the input power to the converter disconnected, change the input voltage or the LED string voltage within the specifications mentioned. The current output of the HV9911DB4 will remain very steady over the entire line range.

With the supply turned off, change the LED string voltage within the specified limits and turn the power supply back on. The current will still be regulated at around 700mA.

Open LED test: Connect a voltmeter across the output terminals of the HV9911DB4. Start the demoboard normally and once the LED current reaches a steady state, unplug one end of the LED string from the demoboard. The output voltage will rise to about 30V and the HV9911DB4 will shut down. To restart the converter, disconnect and reconnect the input voltage (recycle the power to the board).

Short Circuit Test: When the HV9911DB4 is operating in a steady state, connect a jumper across the terminals of the LED string. Notice that the output current will immediately go to zero and the converter will shut down. To restart the HV9911DB4, recycle the input power to the demoboard.

PWM Dimming: With the input voltage to the board disconnected, apply a TTL-compatible, push-pull square wave signal between PWM and GND terminals of connector J3 as shown in the connection diagram. Turn the input voltage back on and adjust the duty cycle and/or frequency of the PWM dimming signal. The output current will track the PWM dimming signal. Note that although the converter operates perfectly well at 1kHz PWM dimming frequency, the best PWM dimming ratio can be obtained at lower frequencies, like 100Hz or 200Hz.

Typical Results

1. Efficiency: The efficiency of the converter at various LED string voltages are shown in Fig. 1 (measured at the nominal input voltage of 24V). Fig.2 shows the full load efficiency of the converter at varying input voltages. The minimum efficiency of 68% for the converter occurs at minimum load voltage.

Fig.1 Efficiency vs. Output Voltage

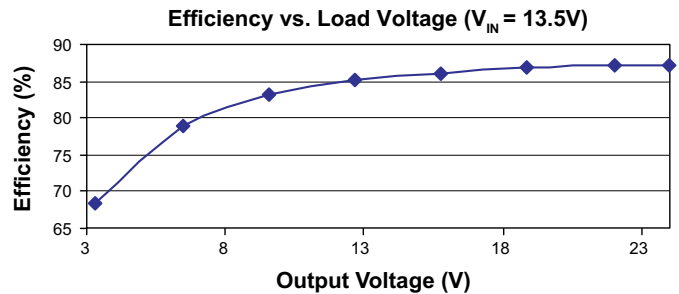
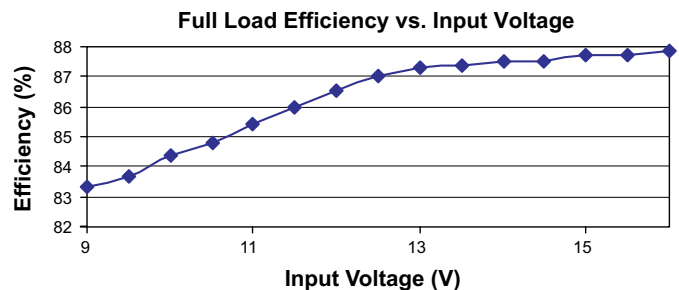

Fig.2 Efficiency vs. Input Voltage



2. Current Regulation: Fig.3 and Fig.4 show the output current regulation vs. load voltage and input voltage respectively. The total current regulation (line and load combined) is less than 1%.

Fig.3 Output Current vs. Output Voltage

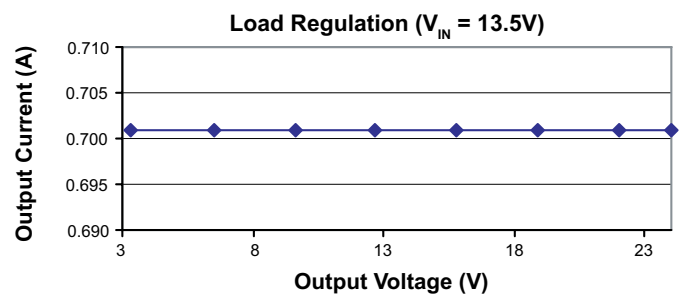
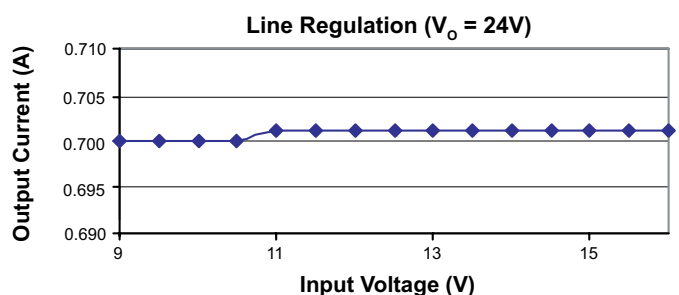
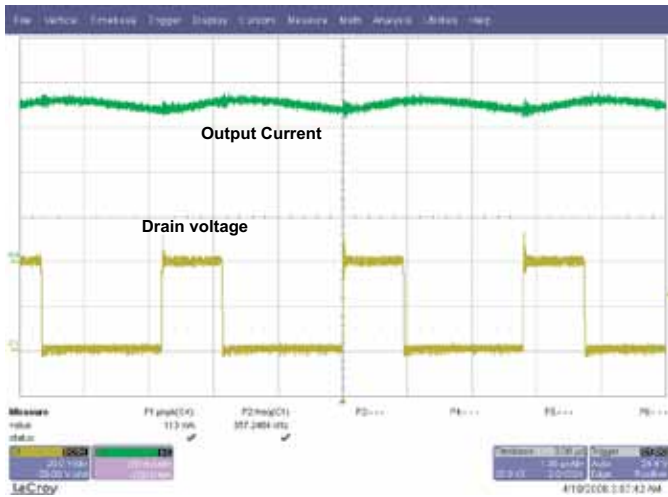

Fig.4 Output Current vs. Input Voltage



3. Normal Operation: The drain voltage of the switching FET and the output current are shown in Fig.5. It can be seen that the converter is switching at 350kHz, and the output current ripple is about 16% (peak to peak).

Fig.5. Switching waveforms for the HV9911DB4



4. Open LED Protection: Open LED protection for the circuit is set at 30V. The waveforms in Fig.6 show the output voltage, drain voltage, and output current during an open LED condition. The time taken for the over voltage protection to shut the IC down will depend on the size of the output capacitor.

Fig.6. Open LED Protection

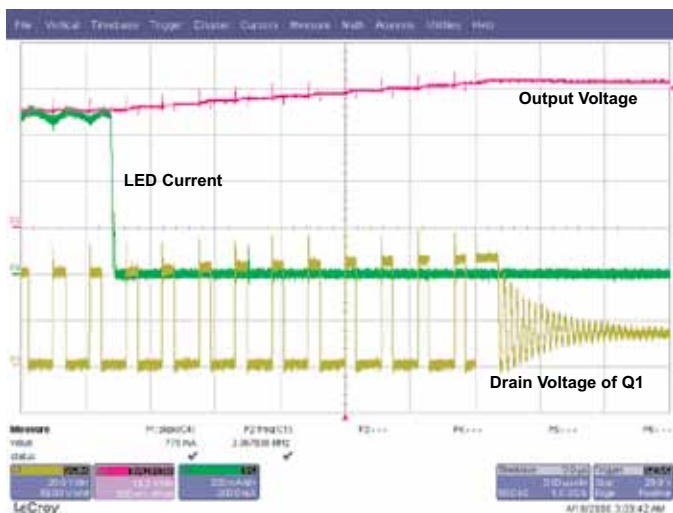

5. Output Short Circuit Protection: Fig.7 shows the waveforms for output short circuit condition. The disconnect FET is turned off in about 300ns. The rise in the output current will depend on the output voltage and the energy stored in the output capacitor.

6. PWM Dimming: Typical PWM dimming response is shown in Fig.8. Fig.9a shows the rise and Fig.9b shows the fall of the LED current on an expanded time scale.

Fig.8: Typical PWM Dimming Waveforms

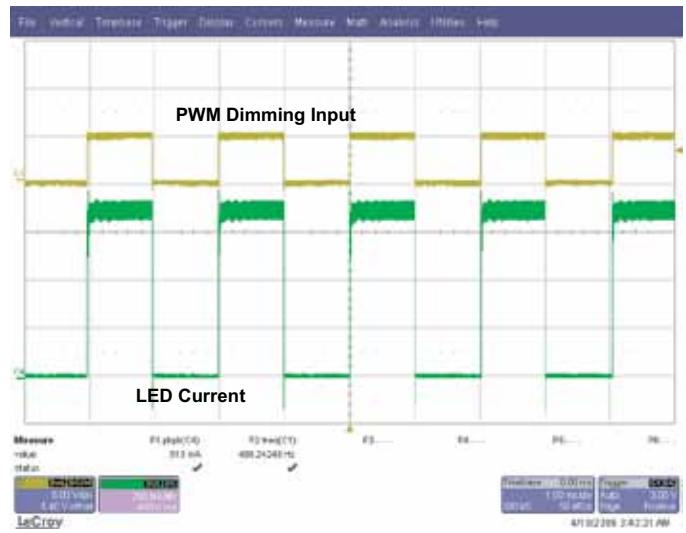

Fig.9a. Rise Time (10µs/div)

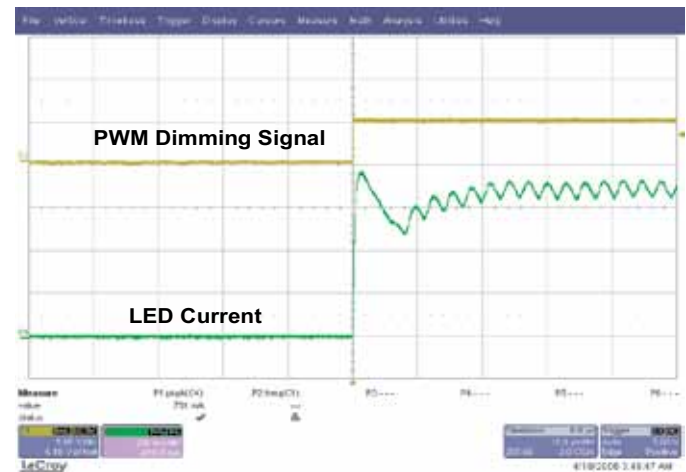
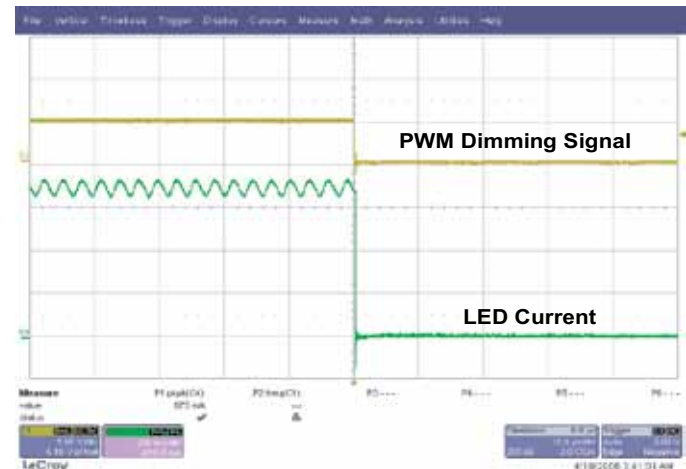

Fig.9b. Fall Time (10µs/div)



7. Input Audio Susceptibility: Fig.10 shows the response of the converter for a step change in the input voltage from 10 to 16V. The current overshoots by 30% and comes back into regulation in 7ms.

8. Input Current Ripple: Fig.10 shows the input current ripple of the converter at full load and 13.5V input. The ripple current is about 4% (peak to peak).

Fig. 10. Response of the HV9911DB4 to an input voltage change
(Time Scale: 1ms/div)

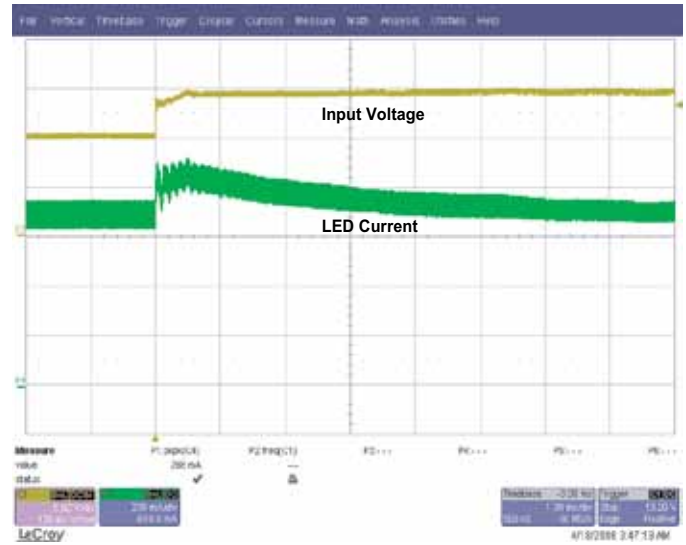

Silk Screen

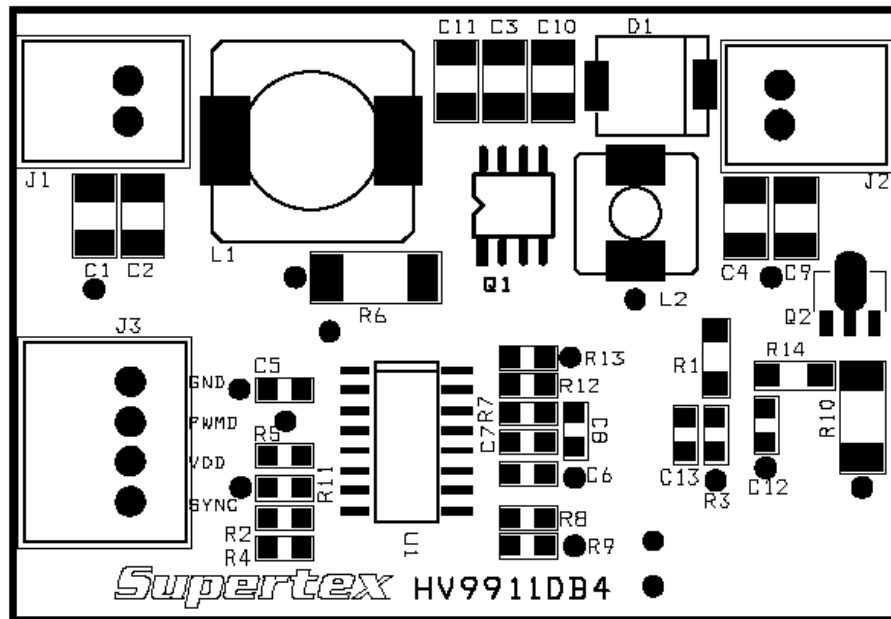

Circuit Schematic:

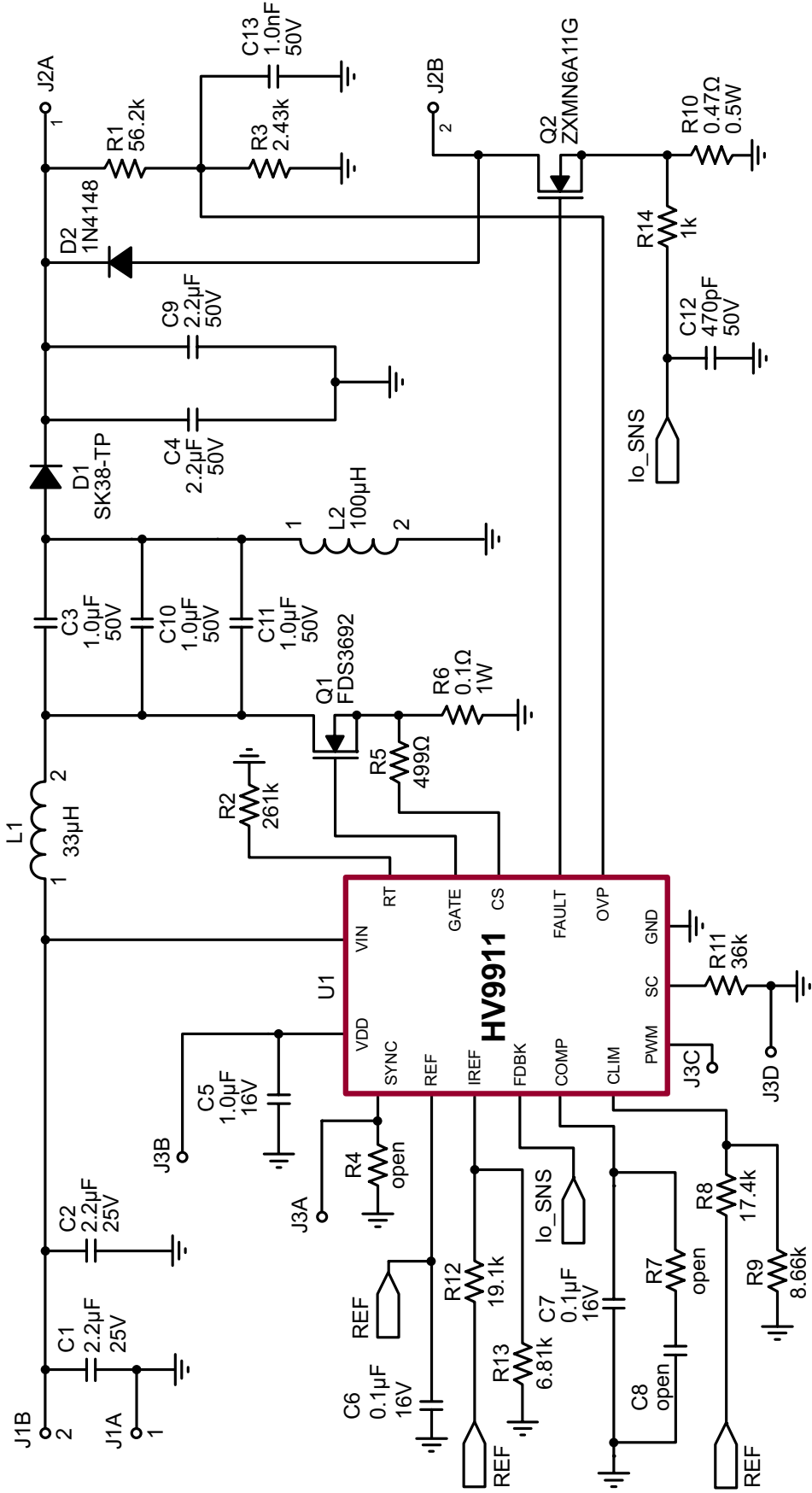

Bill of Materials

Item	Qty	Ref Des	Description	Package	Manufacturer	Manufacturer's Part Number
1	2	C1, C2	2.2 μ F, 25V X7R ceramic chip capacitor	SMD1210	TDK Corp	C3225X7R1E225K
2	3	C3, C10, C11	1.0 μ F, 50V X7R ceramic chip capacitor	SMD1210	Kemet	C1210C105K5RACTU
3	2	C4, C9	2.2 μ F, 50V X7R ceramic chip capacitor	SMD1210	TDK Corp	C3225X7R1H225K
4	1	C5	1.0 μ F, 16V X7R ceramic chip capacitor	SMD0805	TDK Corp	C2012X7R1C105K
5	1	C6, C7	0.1 μ F, 16V X7R ceramic chip capacitor	SMD0805	Murata	GRM219R71C104KA01D
6	3	R4, R7, C8	open	-	-	-
7	1	C12	470pF, 50V, X7R ceramic chip capacitor	SMD0805	Kemet	C0805C471K5RACTU
8	1	C13	1.0nF, 50V X7R ceramic chip capacitor	SMD0805	Kemet	C0805C102K5RACTU
9	1	D1	80V, 3A schottky diode	SMC	Micro Commercial	SK38-TP
10	2	J1, J2	Side Entry 2-pin male header	Thru-Hole	JST Sales	S2B-EH
11	1	J3	Side Entry 4-pin male header	Thru-Hole	JST Sales	S4B-EH
12	1	L1	33 μ H, 3A rms, 6A SAT inductor	SMT	Cooper Electronics	DR127-330
13	1	L2	100 μ H, 0.86A rms, 1.0A SAT inductor	SMT	Cooper Electronics	DR74-101
14	1	Q1	100V, 4.55A N-Channel MOSFET	SO-8	Fairchild	FDS3692
15	1	Q2	60V, 2.7A N-Channel MOSFET	SOT-89	Zetex, Inc.	ZXMN6A11G
16	1	R1	56.2k Ω , 1%, 1/4W chip resistor	SMD1206	-	-
17	1	R2	261k Ω , 1%, 1/8W chip resistor	SMD0805	-	-
18	1	R3	2.43k Ω , 1%, 1/8W chip resistor	SMD0805	-	-
19	1	R5	499 Ω , 1%, 1/8W chip resistor	SMD0805	-	-
20	1	R6	0.1 Ω , 5%, 1W chip resistor	SMD2512	-	--
21	1	R8	17.4k Ω , 1%, 1/8W chip resistor	SMD0805	-	-
22	1	R9	8.66k Ω , 1%, 1/8W chip resistor	SMD0805	-	-
23	1	R10	0.47 Ω , 1%, 1/2W chip resistor	SMD2010	-	-
24	1	R11	36k Ω , 1%, 1/8W chip resistor	SMD0805	-	-
25	1	R12	19.1k Ω , 1%, 1/8W chip resistor	SMD0805	-	-
26	1	R13	6.81k Ω , 1%, 1/8W chip resistor	SMD0805	-	-
27	1	R14	1.0k Ω , 1%, 1/4W chip resistor	SMD1206	-	-
28	1	U1	Switchmode LED Driver	SO-16	Supertex	HV9911NG-G

Supertex inc. does not recommend the use of its products in life support applications, and will not knowingly sell them for use in such applications unless it receives an adequate "product liability indemnification insurance agreement." **Supertex inc.** does not assume responsibility for use of devices described, and limits its liability to the replacement of the devices determined defective due to workmanship. No responsibility is assumed for possible omissions and inaccuracies. Circuitry and specifications are subject to change without notice. For the latest product specifications refer to the **Supertex inc.** (website: <http://www.supertex.com>)