

# TL70 Wireless Modular Tower Light



## Datasheet



The Sure Cross® TL70 Wireless Modular Tower Light combines the best of Banner's popular Tower Light family with its reliable, field-proven, Sure Cross wireless architecture.

- Available in 900 MHz and 2.4 GHz ISM radio frequencies
- Up to six colors, or five colors plus audible, in one device
- Rugged, water-resistant IP65 housing with UV-stabilized material
- Bright, uniform indicator segments appear gray when off to eliminate false indication from ambient light
- Two-way communication - light segments can be controlled with the input wires or the master radio
- Input wires can be configured as auxiliary sourcing inputs from external devices or as a 20 Hz, 32-bit event counter



**Important:** Please download the complete TL70 Wireless Modular Tower Light technical documentation, available in multiple languages, from [www.bannerengineering.com](http://www.bannerengineering.com) for details on the proper use, applications, Warnings, and installation instructions of this device.



**Important:** Por favor descargue desde [www.bannerengineering.com](http://www.bannerengineering.com) toda la documentación técnica de los TL70 Wireless Modular Tower Light, disponibles en múltiples idiomas, para detalles del uso adecuado, aplicaciones, advertencias, y las instrucciones de instalación de estos dispositivos.



**Important:** Veuillez télécharger la documentation technique complète des TL70 Wireless Modular Tower Light sur notre site [www.bannerengineering.com](http://www.bannerengineering.com) pour les détails sur leur utilisation correcte, les applications, les notes de sécurité et les instructions de montage.

## Models

Figure 1. Model key for TL70 segments

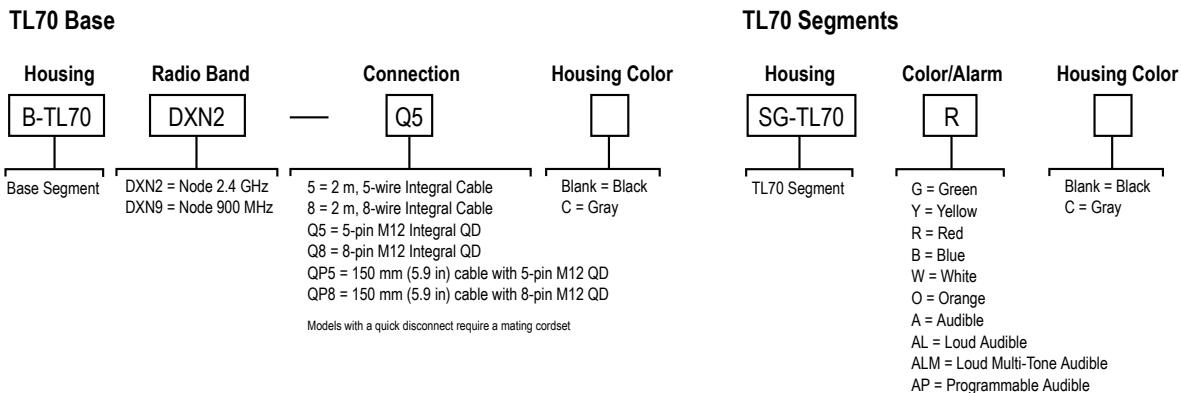

Select the 5-pin base for tower light configurations of up to three modules. Select the 8-pin base for tower light configurations of up to six modules.

- Example base model number: B-TL70DXN2-Q5
- Example light segment model number: SG-TL70-G
- Example audible segment model number: SG-TL70-A



Figure 2. Model key for TL70 pre-assembled models

**TL70 Pre-Assembled Models**

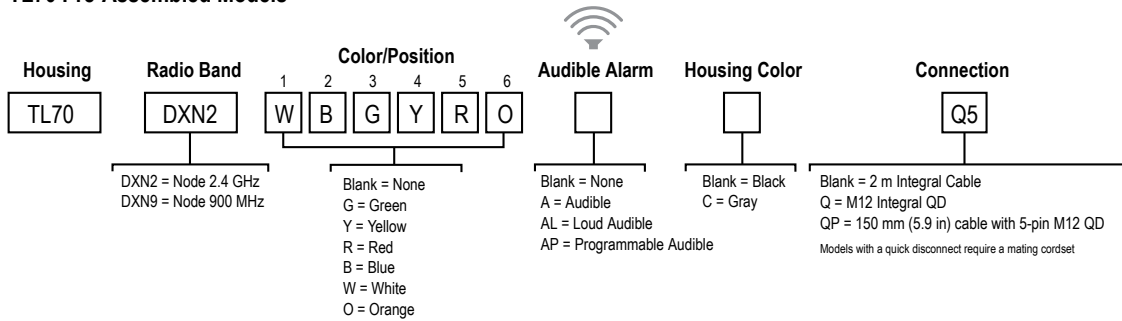

- Example pre-assembled model number: TL70DXN2GYRAQ

**Configuration Instructions**

**Configuring the Modules**



Turn on the appropriate DIP switch to set the order of the components, counting up from the tower light's base.

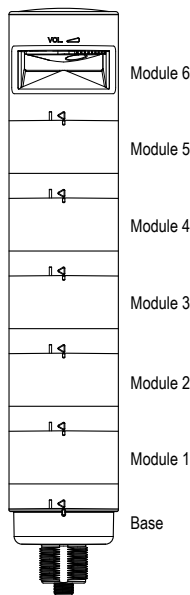

Assembly Options		DIP Switches							
		1	2	3	4	5	6	7	8
Light and Standard Audible Components	Module 1	ON							
	Module 2		ON						
	Module 3			ON					
	Module 4				ON				
	Module 5					ON			
	Module 6						ON		

Light Module Flash Rate	3 Hz							ON	OFF
	1.5 Hz							ON	ON
	Solid On*							OFF	OFF

Standard Audible Module Settings	Pulse 1.5 Hz							ON	OFF
	Chirp Alarm							ON	ON
	Siren Alarm							OFF	ON
	Continuous Alarm*							OFF	OFF

Assembly Options		DIP Switches									
		1	2	3	4	5	6	7	8	9	10
Loud Audible Module Settings	Pulse 1.5 Hz							ON	OFF		
	Chirp Alarm							ON	ON		
	Siren Alarm							OFF	ON		
	Continuous Alarm*							OFF	OFF		
	Low Intensity*									OFF	OFF
	Med. Intensity									ON	OFF
	Med./Low Intensity									OFF	ON
	Loud Intensity									ON	ON

\* Factory default setting

## Assembling the Modules

Figure 3. Assembling the modules

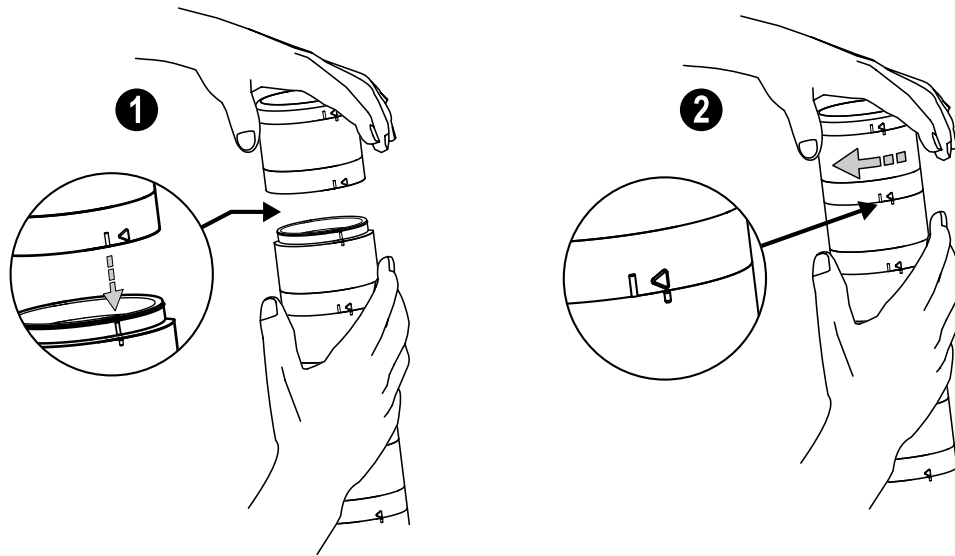

To assemble the modules:

1. Align the notches on each module and press together.
2. Rotate the top module clockwise to lock into place (notches shown in the locked position).

## Configuring the Radio Module

### Set the Radio Module DIP Switches

Before applying power to the device, set the radio module's DIP switches. Default configurations are noted with (\*).

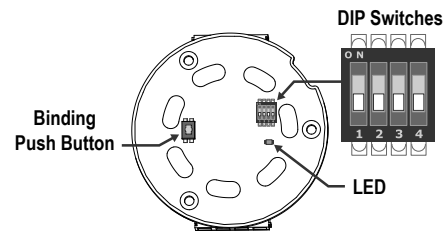

DIP Switch 1: Radio Transmit Power	900 MHz Models	2.4 GHz Models
OFF *	1 Watt (30 dBm) operation	Disabled
ON	250 mW (24 dBm) operation	

The 900 MHz radios transmit at 1 Watt (30 dBm) or 250 mW (24 dBm). The 250 mW mode reduces the radio's range but improves the battery life in short range applications. For 2.4 GHz models, this DIP switch is disabled. The transmit power for 2.4 GHz is fixed at about 65 mW EIRP (18 dBm).

DIP Switch 2: Input Wires	900 MHz Models and 2.4 GHz Models
OFF *	Input wires control lights
ON	Disables wired input control of lights and converts wires to auxiliary Inputs

If there are no lights at the end of the input wires to turn on, the inputs still function as a sourcing input.

DIP Switch 3: Event Counter	900 MHz Models and 2.4 GHz Models
OFF *	Default I/O operation
ON	8-pin Models: Configure input 5 as a 32-bit synchronous counter at a maximum frequency of 20 Hz; disable input 6 (the counter requires two registers) 5-Pin Models: Configure input 3 as a 32-bit synchronous counter at a maximum frequency of 20 Hz

*The event counter is active for RF firmware revision 5.3 or higher.*

For the 8-pin models: In the default position (OFF), inputs 1 through 6 control the tower lights. When DIP switch 3 is ON, input 5 wire is the counter input and input 6 wire is disabled. Registers 5 and 6 store the 32-bit synchronous counter count. Inputs 5 and 6 are independent from the lights and will not drive any lights they are wired to. Inputs 1 through 4 function normally.

For the 5-pin models: In the default position (OFF), inputs 1 through 3 control the tower lights. When DIP switch 3 is ON, input 3 wire is the counter input. Registers 3 and 4 store the 32-bit synchronous counter count. Input 3 is independent from the lights and will not drive any lights they are wired to. Inputs 1 and 2 function normally.

DIP Switch 4: Bit Packing I/O	900 MHz Models and 2.4 GHz Models
OFF *	Default I/O operation
ON	Bit-packed I/O with all inputs in Modbus register 1 and all outputs in Modbus register 9. All other Modbus registers are disabled.

*Bit packing is active for RF firmware revision 5.8 or higher.* Bit packing uses a single register, or range of contiguous registers, to represent I/O values. This allows you to read or write multiple I/O values with a single Modbus message. Input 1 is stored in the least significant bit of register 1. Output 1 is stored in the least significant bit of register 9.

## Event Counter

To use the event counter, the measured (logic high) signal must be greater than or equal to 25 ms. The 32-bit count is stored in I/O registers 3 and 4 for 5-pin models and 5 and 6 for 8-pin models.

To zero out (clear) the event counter,

- Map an input/button on a Gateway to Node register 14 to clear the counter when the input/button is activated; or
- From a host system, write a 1 (the output must transition from a zero to a one to reset the counter) to Node register 14 or write a 5424 (0x1530) to Node control register 15.

*RF firmware revision 5.3 or higher (on all products released after 3/20/2015) is required to use this feature.*

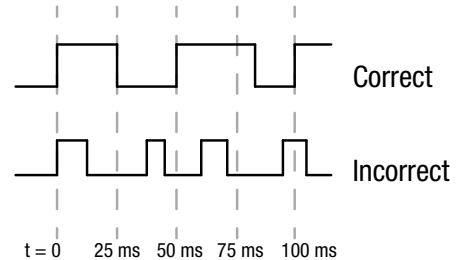

## Bind the TL70 to the Gateway and Assign the Node Address

Before beginning the binding procedure, apply power to all the devices.

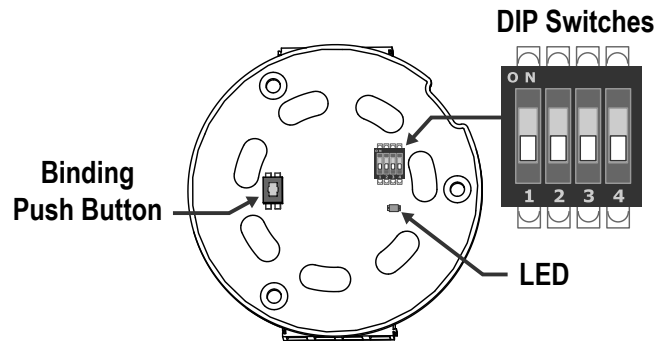

1. Enter binding mode.
  - For housed Gateways, triple-click button 2.
  - For board-level Gateway modules, triple-click the button.
  - For DXMs, under the **ISM Radio** menu, use the down arrow button to highlight the **Binding** menu. Click **ENTER**.

On the board modules, the green/red LED flashes. On the housed models, both LEDs flash red.
2. Assign the TL70 a Node address using the Gateway's rotary dials or the DXM's arrow keys.
  - On a Gateway: Use the left rotary dial for the left digit and the right rotary dial for the right digit. For example, to assign your TL70 to Node 01, set the left dial to 0 and the right dial to 1.
  - On the DXM: Use the arrow keys to select the Node ID, then press **ENTER**. The display shows **Binding**.

Valid Node addresses are 01 through 47.
3. Access the circuit board in the radio module of the TL70.
4. Enter binding mode on the TL70 by triple-clicking the binding button.

The bicolor LED flashes alternately while it searches for a Gateway in binding mode. After the TL70 is bound, the LED is red and green for four seconds (looks amber), then it flashes four times (looks amber). The TL70 automatically exits binding mode, cycles power, and enters Run mode.
5. For DXMs, click **BACK** to exit binding for that specific Node address.
6. Label the Node with the assigned address for future references.

This makes it easier to identify the physical Node location within a multi-Node network.
7. Reassemble the components back onto the base.
8. Repeat steps 2 through 5 for as many TL70 Wireless Modular Tower Lights as are needed for your network.
9. After binding all TL70s, exit binding mode on the Gateway.
  - For housed Gateways, double-click button 2.
  - For board-level Gateway modules, double-click the button.
  - For DXM models, click **BACK** until you return to the main menu.

### LED Behavior for the Nodes

Nodes do not sample inputs until they are communicating with the Gateway. The radios and antennas must be a minimum distance apart to function properly. Recommended minimum distances are:

- 900 MHz 150 mW and 250 mW radios: 6 feet
- 900 MHz 1 Watt radios: 15 feet
- 2.4 GHz 65 mW radios: 1 foot

LED (Bi-color)	Node Status
Flashing green	Radio link okay
Green and red flashing alternately	In Binding mode
Both colors are solid for 4 seconds, then flash 4 times; looks amber	Binding mode is complete
Flashing red, once every 3 seconds	Radio link error
Flashing red, once every second	Device error

### Modes of Operation

**Node Controlled.** The wireless TL70 Node can be operated similar to a wired model where the individual segments are activated by a PLC or manual switch. In this scenario, the Gateway only monitors the status of the light segments. An example application would be remotely monitoring the status of one or multiple machines from a single Gateway.

**Gateway Controlled.** In the Gateway-controlled mode, the TL70 Node only requires 10 V DC to 30 V DC power. Input signals sent from the Gateway have full control over the status of all the segments. An example application would be a call-for-parts application with a TL70 Node mounted to a fork truck and the Gateway mounted in a work cell or stock room. When part pick-up or delivery is needed, the operator sends a signal to the fork truck driver. A multicolor TL70 could be used when there are multiple pick-up or delivery locations.

### Sure Cross® DX80 Performance Configuration Software

The configuration software offers an easy way to link I/O points in your wireless network, view I/O register values, and set system communication parameters when a host system is not part of the wireless network. The software runs on any computer with the Windows Vista, Windows 7, Windows 8, or Windows 10 operating system.

Figure 4. Device Configuration screen

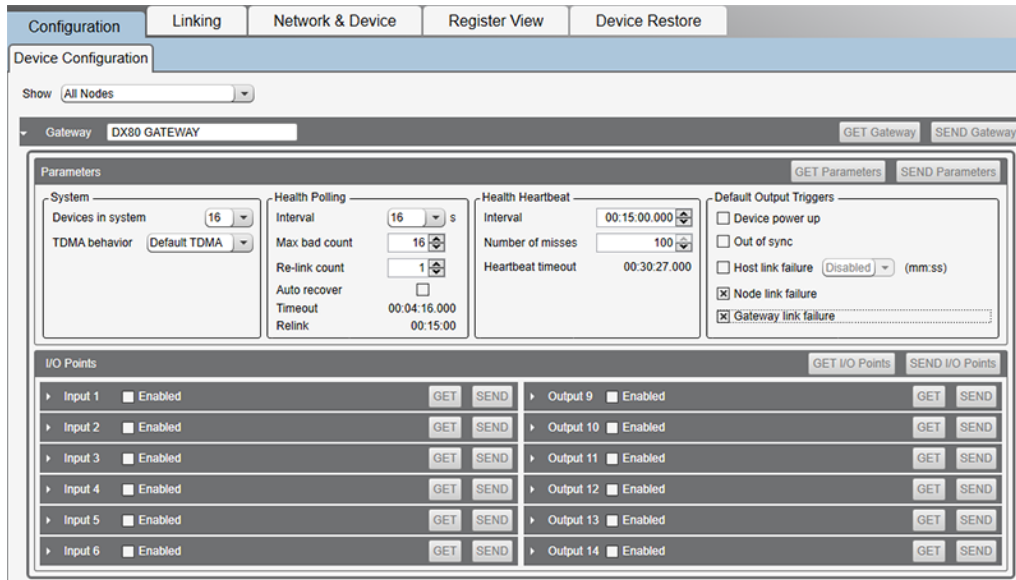

Use a USB to RS-485 adapter cable to connect a standalone DX80 Gateway to the computer. For DXM Controllers with an internal DX80 radio, connect a computer to the DXM Controller using the supplied USB or Ethernet connection. Download the most recent revisions of the configuration software from Banner Engineering's website: <https://www.bannerengineering.com/us/en/products/wireless-sensor-networks/reference-library/software.html>.

The USB to RS-485 adapter cable is not required for the DXM Controller. For standalone DX80 Gateway devices use:

- USB to RS-485 adapter cable model **BWA-UCT-900** for 1 Watt radios
- USB to RS-485 adapter cable model **BWA-HW-006** for all other radios

### Modbus Registers

Modbus holding registers for the 5-pin models.

I/O	Modbus Holding Register		I/O Type	I/O Range		Holding Register Representation (Dec.)		Module #
	Gateway	Any Node		Min.	Max.	Min.	Max.	
1	1	1 + (Node# × 16)	Discrete IN 1 / Bit-packed inputs	0	1	0	1	M1
2	2	2 + (Node# × 16)	Discrete IN 2	0	1	0	1	M2
3	3	3 + (Node# × 16)	Discrete IN 3 / 32-bit event counter high word	0	1 / 65535	0	1 / 65535	M3
4	4	4 + (Node# × 16)	Reserved / 32-bit event counter low word	0	65535	0	65535	M4
		...						
8	8	8 + (Node# × 16)	Device Message					

I/O	Modbus Holding Register		I/O Type	I/O Range		Holding Register Representation (Dec.)		Module #
	Gateway	Any Node		Min.	Max.	Min.	Max.	
9	9	9 + (Node# × 16)	Discrete OUT 9 / Bit-picked outputs	0	1	0	1	M1
10	10	10 + (Node# × 16)	Discrete OUT 10	0	1	0	1	M2
11	11	11 + (Node# × 16)	Discrete OUT 11	0	1	0	1	M3
12	12	12 + (Node# × 16)	Discrete OUT 12	0	1	0	1	M4
13	13	13 + (Node# × 16)	Discrete OUT 13	0	1	0	1	M5
14	14	14 + (Node# × 16)	Discrete OUT 14 / Zero out (clear) the counter	0	1	0	1	M6
15	15	15 + (Node# × 16)	Control Message					
16	16	16 + (Node# × 16)	Reserved					

Modbus holding registers for the 8-pin models.

I/O	Modbus Holding Register		I/O Type	I/O Range		Holding Register Representation (Dec.)		Module #
	Gateway	Any Node		Min.	Max.	Min.	Max.	
1	1	1 + (Node# × 16)	Discrete IN 1 / Bit-packed inputs	0	1	0	1	M1
2	2	2 + (Node# × 16)	Discrete IN 2	0	1	0	1	M2
3	3	3 + (Node# × 16)	Discrete IN 3	0	1	0	1	M3
4	4	4 + (Node# × 16)	Discrete IN 4	0	1	0	1	M4
5	5	5 + (Node# × 16)	Discrete IN 5 / 32-bit event counter high word	0	1 / 65535	0	1 / 65535	M5
6	6	6 + (Node# × 16)	Discrete IN 6 / 32-bit event counter low word	0	1 / 65535	0	1 / 65535	M6
7	7	7 + (Node# × 16)	Reserved					
8	8	8 + (Node# × 16)	Device Message					
9	9	9 + (Node# × 16)	Discrete OUT 9 / Bit-picked outputs	0	1	0	1	M1
10	10	10 + (Node# × 16)	Discrete OUT 10	0	1	0	1	M2
11	11	11 + (Node# × 16)	Discrete OUT 11	0	1	0	1	M3
12	12	12 + (Node# × 16)	Discrete OUT 12	0	1	0	1	M4
13	13	13 + (Node# × 16)	Discrete OUT 13	0	1	0	1	M5
14	14	14 + (Node# × 16)	Discrete OUT 14 / Zero out (clear) the counter	0	1	0	1	M6
15	15	15 + (Node# × 16)	Control Message					
16	16	16 + (Node# × 16)	Reserved					

Use the User Configuration Tool (UCT) software to define unique synchronous flash patterns for the lights.

### Creating Flash Patterns

Use the DX80 Performance Configuration Software to create the flash pattern.

To create a flash pattern:

1. Enable the appropriate output if it is not yet enabled.
2. Click **GET** to download the input/output current configuration from the device to the configuration software. This automatically populates the Output configuration settings specific to the Node type.
3. For this example, configure output 9 is enabled and configured as discrete output 1 (color 1 for this K70 light). Different models may use distinct output types and I/O configuration values.
4. Define the flash pattern by selecting the appropriate checkboxes in the **Flash Pattern** section. In this example, the light will flash twice a second.
5. Click **SEND** to upload the configuration to the device.

Figure 5. Defining a flash pattern for discrete output 1

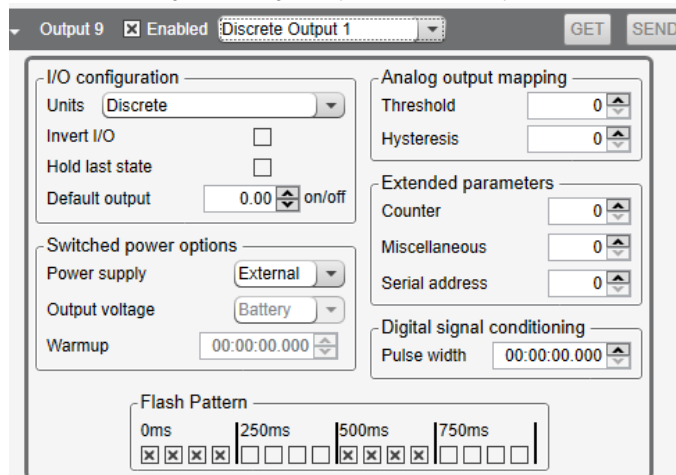

## Wiring Diagrams

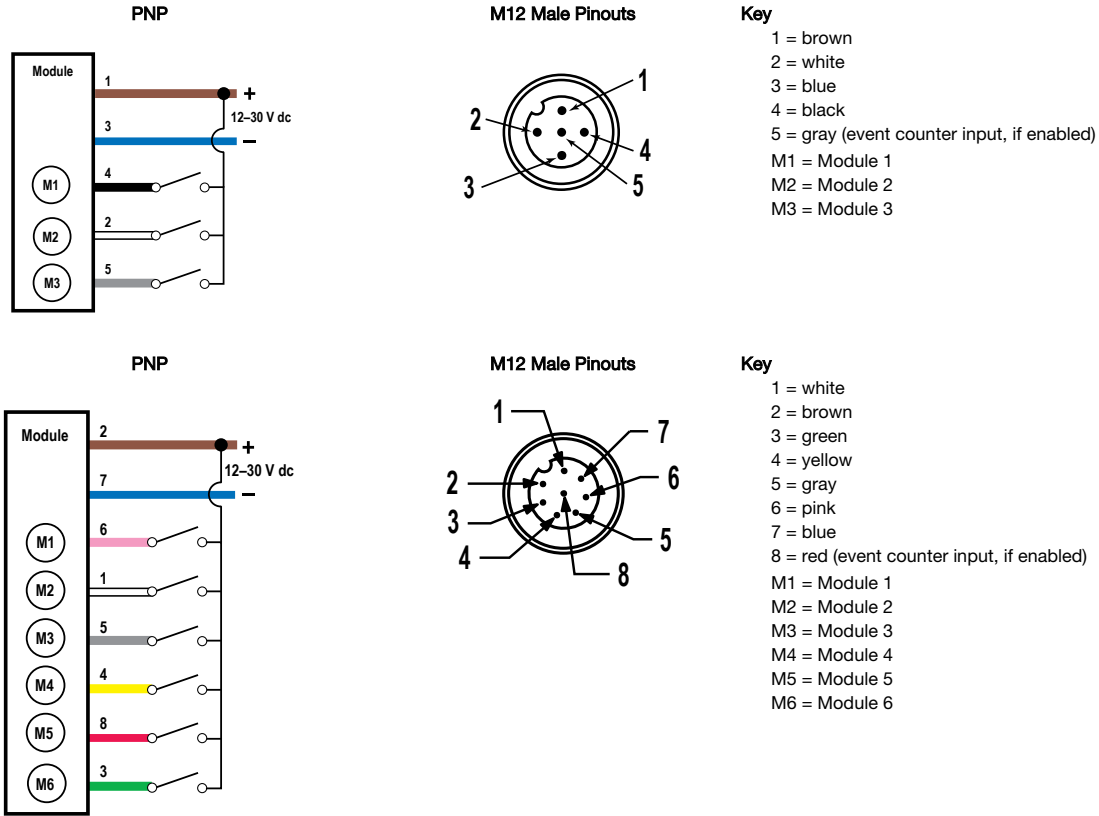

Input wires M1 through M6 can be used to either control the light segments or can be configured as external PNP Inputs. Refer to [Set the Radio Module DIP Switches](#) on page 3 for configuration instructions.

## Specifications

### Performance Radio with Internal Antenna Specifications

**Radio Range** <sup>¶</sup>

900 MHz, 1 Watt: Up to 3.2 km (2 miles) with line of sight (internal antenna)  
2.4 GHz, 65 mW: Up to 1000 m (3280 ft) with line of sight (internal antenna)

**Antenna Minimum Separation Distance**

900 MHz, 150 mW and 250 mW: 2 m (6 ft)  
900 MHz, 1 Watt: 4.57 m (15 ft)  
2.4 GHz, 65 mW: 0.3 m (1 ft)

**Radio Transmit Power**

900 MHz, 1 Watt: 30 dBm (1 W) conducted (up to 36 dBm EIRP)  
2.4 GHz, 65 mW: 18 dBm (65 mW) conducted, less than or equal to 20 dBm (100 mW) EIRP

**Link Timeout (Performance)**

Gateway: Configurable via User Configuration Software  
Node: Defined by Gateway

**Spread Spectrum Technology**

FHSS (Frequency Hopping Spread Spectrum)

**900 MHz Compliance (1 Watt)**

Contains FCC ID: UE3RM1809; FCC Part 15, Subpart C, 15.247  
Contains IC: 7044A-RM1809  
IFT: RCPBARM13-2283



(NOM approval only applies to 900 MHz models)

**2.4 GHz Compliance (DX80-2400 Radio Module)**

Radio module is indicated by the product label marking  
Contains FCC ID: UE300DX80-2400; FCC Part 15, Subpart C, 15.247  
Radio Equipment Directive (RED) 2014/53/EU  
Contains IC: 7044A-DX8024

ANATEL: 15966-21-04042 Este equipamento não tem direito à proteção contra interferência prejudicial e não pode causar interferência em sistemas devidamente autorizados. Para maiores informações, consulte o site da ANATEL [www.gov.br/anatel/pt-br/](http://www.gov.br/anatel/pt-br/)

**2.4 GHz Compliance (SX243 Radio Module)**

Radio module is indicated by the product label marking  
Contains FCC ID: UE3SX243; FCC Part 15, Subpart C, 15.247  
Radio Equipment Directive (RED) 2014/53/EU  
Contains IC: 7044A-SX243

ANATEL: 03737-22-04042 Este equipamento não tem direito à proteção contra interferência prejudicial e não pode causar interferência em sistemas devidamente autorizados. Para maiores informações, consulte o site da ANATEL [www.gov.br/anatel/pt-br/](http://www.gov.br/anatel/pt-br/)

<sup>¶</sup> Range depends on the environment and decreases significantly without line of sight. Always verify your wireless network's range by performing a Site Survey.

## Tower Light Specifications

### Supply Voltage and Current

12 V DC to 30 V DC (Outside the USA: 12 V DC to 24 V DC, ± 10%)<sup>2</sup>  
 900 MHz Consumption: Maximum current draw is < 40 mA and typical current draw is < 30 mA at 24 V DC. (2.4 GHz consumption is less.)

Indicator Color or Audible Model	Maximum Current (mA)	
	at 12 V DC	at 30 V DC
Blue, Green, White	420	150
Red, Yellow, Orange	285	120
Standard Audible	30	30
Loud Audible (Intensity 1)	18	14
Loud Audible (Intensity 2)	40	28
Loud Audible (Intensity 3)	160	70
Loud Audible (Intensity 4)	350	110

### Supply Protection Circuitry

Protected against transient voltages

### Indicators

1 to 6 colors depending on model (Green, Red, Yellow, Blue, White, and Orange)

LEDs are independently selected

**Flash Rates:** 1.5 Hz ±10% and 3 Hz ±10%

### Indicator Response Time

**Off Response:** 150 µs (maximum) at 12 V DC to 30 V DC

**On Response:** 180 ms (maximum) at 12 V DC; 50 ms (maximum) at 30 V DC

### Indicator Characteristics

Color	Dominant Wavelength (nm) or Color Temperature (CCT)	Color Coordinates <sup>3</sup>		Lumen Output (Typical at 25 °C)
		x	y	
Green	525 nm	-	-	92
Red	625 nm	-	-	40
Yellow	590 nm	-	-	22
Blue	470 nm	-	-	32
White	5000 K	-	-	125
Orange	-	0.66	0.33	33

### Operating Conditions

-40 °C to +50 °C (-40 °F to +122 °F)

95% at +50 °C maximum relative humidity (non-condensing)

### Environmental Rating

IP65

### Radiated Immunity HF

10 V/m (EN 61000-4-3)

### Certifications



**Banner Engineering Europe** Park Lane, Culliganlaan 2F bus 3, 1831 Diegem, BELGIUM (CE/UKCA approval only applies to 2.4 GHz models)



**Turck Banner LTD** Blenheim House, Blenheim Court, Wickford, Essex SS11 8YT, Great Britain



### Audible Alarm

**Standard Audible:** 2.6 KHz ± 250 Hz oscillation frequency; maximum intensity (typical) 92 dB at 1 m (3.3 ft)

**Loud Audible:** 2.6 KHz ± 250 Hz oscillation frequency; maximum intensity (typical) at 1 m (3.3 ft)

DIP Switches		Max Intensity (Loud Audible)
9	10	
ON	ON	Intensity 4: 101 dB
OFF	ON	Intensity 3: 99 dB
ON	OFF	Intensity 2: 92 dB
OFF	OFF	Intensity 1: 85 dB

### Audible Adjustment

**Standard Audible:** Rotate the cover until the desired volume is reached

**Loud Audible Adjustment:** Select the desired volume using DIP switches 9 and 10

**Typical Reduction in Sound Intensity with Audible Adjustment (maximum to minimum):**

- **Standard Audible:** 8 dB
- **Loud Audible:** 16 dB

### Connections

5-pin M12 quick disconnect, 8-pin M12 quick disconnect, 150 mm (5.9 in) PVC cable with an M12 quick disconnect, or 2 m (6.5 ft) unterminated cable, depending on model

### Construction

**Bases, Segments, Covers:** Polycarbonate

### Vibration and Mechanical Shock

Vibration: 10 Hz to 55 Hz, 0.5 mm peak-to-peak amplitude per IEC 60068-2-6

Shock: 15G 11 ms duration, half sine wave per IEC 60068-2-27

### Required Overcurrent Protection



**WARNING:** Electrical connections must be made by qualified personnel in accordance with local and national electrical codes and regulations.

Overcurrent protection is required to be provided by end product application per the supplied table.

Overcurrent protection may be provided with external fusing or via Current Limiting, Class 2 Power Supply.

Supply wiring leads < 24 AWG shall not be spliced.

For additional product support, go to [www.bannerengineering.com](http://www.bannerengineering.com).

Supply Wiring (AWG)	Required Overcurrent Protection (Amps)
20	5.0
22	3.0
24	2.0
26	1.0
28	0.8
30	0.5

<sup>2</sup> For European applications, power this device from a Limited Power Source as defined in EN 60950-1.

<sup>3</sup> Refer to CIE 1931 chromaticity diagram or color chart, to show equivalent color with indicated color coordinates.



## Dimensions

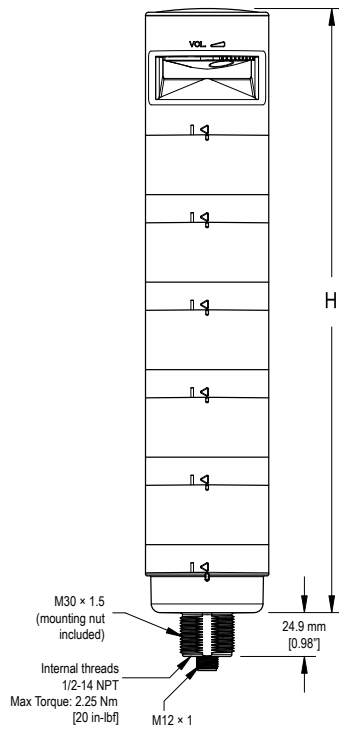

Model	Height (H)
1 light module	87.6 mm (3.45 in)
1 light module, 1 audible module	144.3 mm (5.68 in)
2 light modules	137.3 mm (5.41 in)
2 light modules, 1 audible module	194 mm (7.64 in)
3 light modules	187 mm (7.36 in)
3 light modules, 1 audible module	243.7 mm (9.59 in)
4 light modules	236.7 mm (9.32 in)
4 light modules, 1 audible module	293.4 mm (11.55 in)
5 light modules	286.4 mm (11.28 in)
5 light modules, 1 audible module	343.1 mm (13.5 in)

## Accessories

### Cordsets

5-Pin Threaded M12 Cordsets—Single Ended				
Model	Length	Style	Dimensions	Pinout (Female)
MQDC1-501.5	0.5 m (1.5 ft)	Straight		
MQDC1-503	0.9 m (2.9 ft)			
MQDC1-506	2 m (6.5 ft)			
MQDC1-515	5 m (16.4 ft)			
MQDC1-530	9 m (29.5 ft)			
MQDC1-560	18 m (59 ft)			
MQDC1-506RA	2 m (6.5 ft)	Right-Angle		<p>1 = Brown 2 = White 3 = Blue 4 = Black 5 = Gray</p>
MQDC1-515RA	5 m (16.4 ft)			
MQDC1-530RA	9 m (29.5 ft)			
MQDC1-560RA	19 m (62.3 ft)			

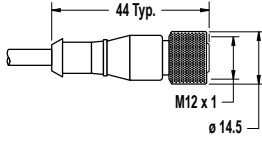
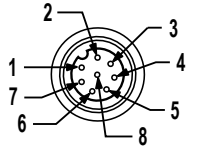
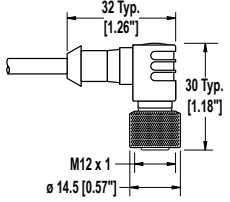
8-Pin Threaded M12 Cordsets with Open-Shield—Single Ended				
Model	Length	Style	Dimensions	Pinout (Female)
MQDC2S-806	2.04 m (6.7 ft)	Straight		  1 = White 2 = Brown 3 = Green 4 = Yellow 5 = Gray 6 = Pink 7 = Blue 8 = Red
MQDC2S-815	5.04 m (16.54 ft)			
MQDC2S-830	10.04 m (32.95 ft)			
MQDC2S-850	16 m (52.49 ft)	Right-Angle		
MQDC2S-806RA	2 m (6.56 ft)			
MQDC2S-815RA	5 m (16.4 ft)			
MQDC2S-830RA	10 m (32.81 ft)			
MQDC2S-850RA	16 m (52.49 ft)			

### Mounting Brackets

All measurements are listed in millimeters, unless noted otherwise.

#### SMB30A

- Right-angle bracket with curved slot for versatile orientation
- Clearance for M6 (¼ in) hardware
- Mounting hole for 30 mm sensor
- 12-ga. stainless steel

Hole center spacing: A to B=40  
Hole size: A=ø 6.3, B= 27.1 x 6.3, C=ø 30.5

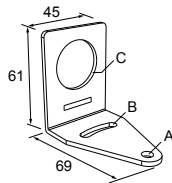

#### SMB30MM

- 12-ga. stainless steel bracket with curved mounting slots for versatile orientation
- Clearance for M6 (¼ in) hardware
- Mounting hole for 30 mm sensor

Hole center spacing: A = 51, A to B = 25.4  
Hole size: A = 42.6 x 7, B = ø 6.4, C = ø 30.1

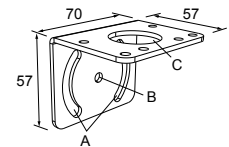

#### SMBAMS30P

- Flat SMBAMS series bracket
- 30 mm hole for mounting sensors
- Articulation slots for 90°+ rotation
- 12-ga. 300 series stainless steel

Hole center spacing: A=26.0, A to B=13.0  
Hole size: A=26.8 x 7.0, B=ø 6.5, C=ø 31.0

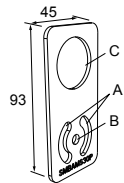

#### SSA-MBK-EEC1

- Single 30 mm hole
- 8 gauge steel, black finish (powder coat)
- Front surface for customer applied labels

Hole size: A = ø 7, B = ø 30

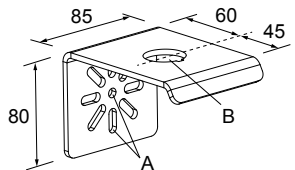

#### LMBE12RA35

- Direct mounting of stand-off pipe, with common bracket type
- Zinc-plated steel
- 1/2-14 NPSM nut
- Mounting distance from the wall to the center of the 1/2-14 NPSM nut is 35 mm

Hole center spacing: 20.0

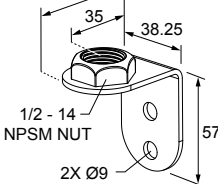

#### LMBE12RA45

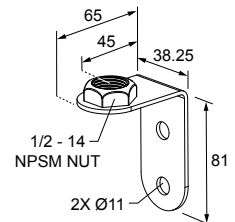

- Direct mounting of stand-off pipe, with common bracket type
- Zinc-plated steel
- 1/2-14 NPSM nut
- Mounting distance from the wall to the center of the 1/2-14 NPSM nut is 45 mm

Hole center spacing: 35.0



### Elevated Mount System

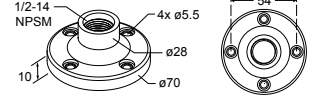
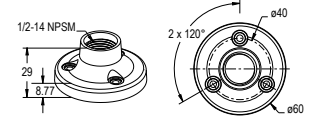

Model	Features	Components
SA-M30 - Black Polycarbonate	<ul style="list-style-type: none"> <li>• Streamlined black PC or Gray PC thread cover</li> <li>• Covers M30 thread on the light base</li> <li>• Mounting hardware included</li> </ul>	
SA-M30C - Gray Polycarbonate		

Model			Features	Components
<b>Polished 304 Stainless Steel</b>	<b>Black Anodized Aluminum</b>	<b>Clear Anodized Aluminum</b>	<ul style="list-style-type: none"> <li>Elevated-use stand-off pipe (½ in. NPSM/DN15)</li> <li>Polished 304 stainless steel, black anodized aluminum, or clear anodized aluminum surface</li> <li>½ in. NPT thread at both ends</li> <li>Compatible with most industrial environments</li> </ul>	
<b>SOP-E12-150SS</b> 150 mm (6 in) long	<b>SOP-E12-150A</b> 150 mm (6 in) long	<b>SOP-E12-150AC</b> 150 mm (6 in) long		
<b>SOP-E12-300SS</b> 300 mm (12 in) long	<b>SOP-E12-300A</b> 300 mm (12 in) long	<b>SOP-E12-300AC</b> 300 mm (12 in) long		
<b>SOP-E12-900SS</b> 900 mm (36 in) long	<b>SOP-E12-900A</b> 900 mm (36 in) long	<b>SOP-E12-900AC</b> 900 mm (36 in) long	<ul style="list-style-type: none"> <li>Streamlined black acetal or white UHMW mounting base adapter/cover</li> <li>Connects between ½ in. NPSM/DN15 pipe and 30 mm (1-3/16 in) drilled hole</li> <li>Mounting hardware included</li> </ul>	
<b>SA-E12M30</b> - Black Acetal				
<b>SA-E12M30C</b> - White UHMW				

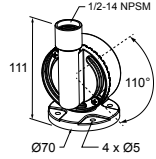
Pipe Mounting Flange			
Model	Features	Construction	
<b>SA-F12</b>	<ul style="list-style-type: none"> <li>Elevated-use stand-off pipes (½ in, NPSM/ DN15)</li> <li>M5 mounting hardware and nitrile gasket included</li> </ul>	Die-cast zinc base with black paint	
<b>SA-F12-3</b>	<ul style="list-style-type: none"> <li>Elevated-use stand-off pipes (½ in, NPSM/ DN15)</li> <li>M4 mounting hardware and nitrile blend gasket included</li> </ul>	Black Polycarbonate	

Foldable Mounting Brackets			
Model	Features	Construction	
<b>SA-FFB12</b>	<ul style="list-style-type: none"> <li>For use with 1/2 inch stand-off pipes</li> <li>Stainless steel hardware</li> </ul>	Black polycarbonate	
<b>SA-FFB12C</b>		Gray polycarbonate	

### LMB Sealed Right-Angle Bracket

Model	Description	Construction	
<b>LMB30RA</b>	<b>Direct-Mount Models:</b> Bracket kit with base, 30 mm adapter, set screw, fasteners, O-rings, and gaskets.	Black polycarbonate	
<b>LMB30RAC</b>		Gray polycarbonate	
<b>LMBE12RA</b>	<b>Pipe-Mount Models:</b> Bracket kit with base, ½-14 pipe adapter, set screw, fasteners, O-rings, and gaskets. For use with stand-off pipe (listed and sold separately).	Black polycarbonate	
<b>LMBE12RAC</b>		Gray polycarbonate	

## Banner Engineering Corp. Limited Warranty

Banner Engineering Corp. warrants its products to be free from defects in material and workmanship for one year following the date of shipment. Banner Engineering Corp. will repair or replace, free of charge, any product of its manufacture which, at the time it is returned to the factory, is found to have been defective during the warranty period. This warranty does not cover damage or liability for misuse, abuse, or the improper application or installation of the Banner product.

**THIS LIMITED WARRANTY IS EXCLUSIVE AND IN LIEU OF ALL OTHER WARRANTIES WHETHER EXPRESS OR IMPLIED (INCLUDING, WITHOUT LIMITATION, ANY WARRANTY OF MERCHANTABILITY OR FITNESS FOR A PARTICULAR PURPOSE), AND WHETHER ARISING UNDER COURSE OF PERFORMANCE, COURSE OF DEALING OR TRADE USAGE.**

This Warranty is exclusive and limited to repair or, at the discretion of Banner Engineering Corp., replacement. **IN NO EVENT SHALL BANNER ENGINEERING CORP. BE LIABLE TO BUYER OR ANY OTHER PERSON OR ENTITY FOR ANY EXTRA COSTS, EXPENSES, LOSSES, LOSS OF PROFITS, OR ANY INCIDENTAL, CONSEQUENTIAL OR SPECIAL DAMAGES RESULTING FROM ANY PRODUCT DEFECT OR FROM THE USE OR INABILITY TO USE THE PRODUCT, WHETHER ARISING IN CONTRACT OR WARRANTY, STATUTE, TORT, STRICT LIABILITY, NEGLIGENCE, OR OTHERWISE.**

Banner Engineering Corp. reserves the right to change, modify or improve the design of the product without assuming any obligations or liabilities relating to any product previously manufactured by Banner Engineering Corp. Any misuse, abuse, or improper application or installation of this product or use of the product for personal protection applications when the product is identified as not intended for such purposes will void the product warranty. Any modifications to this product without prior express approval by Banner Engineering Corp will void the product warranties. All specifications published in this document are subject to change; Banner reserves the right to modify product specifications or update documentation at any time. Specifications and product information in English supersede that which is provided in any other language. For the most recent version of any documentation, refer to: [www.bannerengineering.com](http://www.bannerengineering.com).

For patent information, see [www.bannerengineering.com/patents](http://www.bannerengineering.com/patents).

### FCC Part 15 Class A

This equipment has been tested and found to comply with the limits for a Class A digital device, pursuant to part 15 of the FCC Rules. These limits are designed to provide reasonable protection against harmful interference when the equipment is operated in a commercial environment. This equipment generates, uses, and can radiate radio frequency energy and, if not installed and used in accordance with the instruction manual, may cause harmful interference to radio communications. Operation of this equipment in a residential area is likely to cause harmful interference in which case the user will be required to correct the interference at his own expense.

## Industry Canada

Contains IC: 7044A-DX8024 or 7044A-SX243—This device contains licence-exempt transmitters(s)/receiver(s) that comply with Innovation, Science and Economic Development Canada's licence-exempt RSS(s). Operation is subject to the following two conditions:

1. This device may not cause interference.
2. This device must accept any interference, including interference that may cause undesired operation of the device.

Cet appareil contient des émetteurs/récepteurs exemptés de licence conformes à la norme Innovation, Sciences, et Développement économique Canada. L'exploitation est autorisée aux deux conditions suivantes:

1. L'appareil ne doit pas produire de brouillage.
2. L'utilisateur de l'appareil doit accepter tout brouillage radioélectrique subi, même si le brouillage est susceptible d'en compromettre le fonctionnement.

## Notas Adicionales

Información México: La operación de este equipo está sujeta a las siguientes dos condiciones: 1) es posible que este equipo o dispositivo no cause interferencia perjudicial y 2) este equipo debe aceptar cualquier interferencia, incluyendo la que pueda causar su operación no deseada.

Banner es una marca registrada de Banner Engineering Corp. y podrán ser utilizadas de manera indistinta para referirse al fabricante. "Este equipo ha sido diseñado para operar con las antenas tipo Omnidireccional para una ganancia máxima de antena de 6 dBd y Yagi para una ganancia máxima de antena 10 dBd que en seguida se enlistan. También se incluyen aquellas con aprobación ATEX tipo Omnidireccional siempre que no excedan una ganancia máxima de antena de 6dBd. El uso con este equipo de antenas no incluidas en esta lista o que tengan una ganancia mayor que 6 dBd en tipo omnidireccional y 10 dBd en tipo Yagi, quedan prohibidas. La impedancia requerida de la antena es de 50 ohms."

Antenas SMA	Modelo	Antenas Tipo-N	Modelo
Antena, Omni 902-928 MHz, 2 dBd, junta de caucho, RP-SMA Macho	<b>BWA-902-C</b>	Antena, Omni 902-928 MHz, 6 dBd, fibra de vidrio, 1800mm, N Hembra	<b>BWA-906-A</b>
Antena, Omni 902-928 MHz, 5 dBd, junta de caucho, RP-SMA Macho	<b>BWA-905-C</b>	Antena, Yagi, 900 MHz, 10 dBd, N Hembra	<b>BWA-9Y10-A</b>

## Mexican Importer

Banner Engineering de México, S. de R.L. de C.V.  
David Alfaro Siqueiros 103 Piso 2 Valle oriente  
San Pedro Garza Garcia Nuevo León, C. P. 66269

81 8363.2714