

AN-2208 TPS92550 450mA 36V LED Driver Micro-Module Evaluation Board

1 Introduction

The TPS92550 Constant Current Buck LED Driver Micro-Module drives maximum 450mA LED current up to 10 LEDs in a single string (maximum 14W). It integrates all the power components including the power inductor. The TPS92550 provides a full turn-key , highly efficient solution for wide range of single string LED lighting applications with up to 96% power efficiency. The TPS92550 accepts an input voltage ranging from 4.5V to 36V and delivers a highly accurate 350mA LED current as default. The LED current is adjustable from 300mA to 450mA by charging a single external resistor.

The module operates at constant switching frequency (400kHz) with low Electro Magnetic Interference(EMI) complying with EN55015 standard. The module has fast control loop to realize fine LED current pulse yielding 256–step PWM dimming resolution at 240Hz for general lighting. Protection features include thermal shutdown, input under-voltage lockout, LED open-circuit and short-circuit protections. The TPS92550 Micro-Module is available in PFM 7 pin power package.

2 Board Specifications

- $V_{IN} = 4.5V$ to 36V
- $I_{LED} = 350mA$ (default I_{LED} setting, refer to [Table 4](#) for other I_{LED} settings)
- $I_{LED} = 300mA$ to 450mA
- Designed on two layers, all two layers are 2oz. copper weight.

3 Evaluation Board Design For I_{LED} Setting and EMI

The evaluation board schematic is shown as [Figure 3](#). The default LED current is set at 350mA. By proper setting the resistor values of RIADJ and RVREF (They are not in place but solder pads are reserved), the LED current can be adjusted from 300mA to 450mA, please refer to [Figure 1](#) and [Figure 2](#) for their setting values. The evaluation board is tested and passes radiated emissions standards (EN55015), please refer to [Figure 30](#), [Figure 31](#), [Figure 33](#), [Figure 34](#), [Figure 36](#), and [Figure 37](#) for the performance.

NOTE: the COUT capacitor (2.2 μ F) on board is critical to suppress the Electro Magnetic Interference(EMI) for the performance as shown.

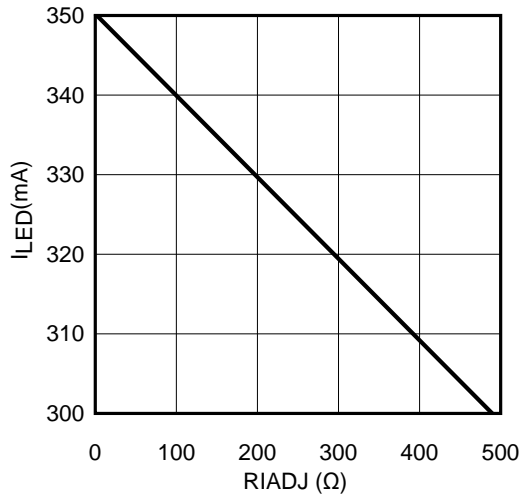

Figure 1. LED current vs. RIADJ
RVREF = open

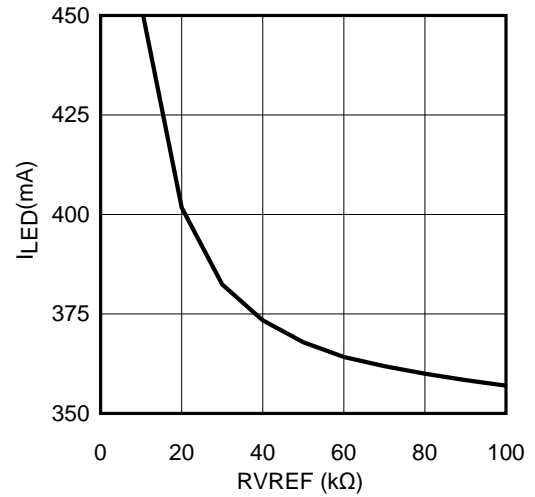

Figure 2. LED current vs. RVREF
RIADJ = 0Ω

4 Complete Circuit Schematic

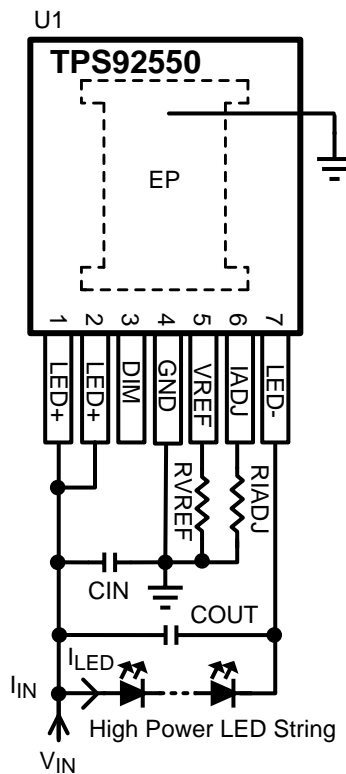

Figure 3. Complete Evaluation Board Schematic

Table 1. Bill of Materials for Evaluation Board, $V_{IN} = 24V$, $I_{LED} = 300mA$, No of LED = 2–7

Designator	Description	Case Size	Manufacturer	Manufacturer P/N	Quantity
U1	LED Micro-Module Driver	PFM-7	Texas Instruments	TPS92550	1
CIN	2.2 μF , X7R, 100V	1210	Murata	GRM32ER72A225KA35L	1
COU	2.2 μF , X7R, 100V	1210	Murata	GRM32ER72A225KA35L	1
RIADJ	499 Ω	0603	Vishay	CRCW0603499RFKEA	1
RVREF	No connection	N/A	N/A	N/A	0

Table 2. Bill of Materials for Evaluation Board, $V_{IN} = 24V$, $I_{LED} = 350mA$, No of LED = 2–7

Designator	Description	Case Size	Manufacturer	Manufacturer P/N	Quantity
U1	LED Micro-Module Driver	PFM-7	Texas Instruments	TPS92550	1
CIN	2.2 μF , X7R, 100V	1210	Murata	GRM32ER72A225KA35L	1
COU	2.2 μF , X7R, 100V	1210	Murata	GRM32ER72A225KA35L	1
RIADJ	0 Ω	0603	Vishay	CRCW06030000Z0EA	1
RVREF	No connection	N/A	N/A	N/A	0

Table 3. Bill of Materials for Evaluation Board, $V_{IN} = 24V$, $I_{LED} = 450mA$, No of LED = 2–7

Designator	Description	Case Size	Manufacturer	Manufacturer P/N	Quantity
U1	LED Micro-Module Driver	PFM-7	Texas Instruments	TPS92550	1
CIN	2.2 μF , X7R, 100V	1210	Murata	GRM32ER72A225KA35L	1
COU	2.2 μF , X7R, 100V	1210	Murata	GRM32ER72A225KA35L	1
RIADJ	0 Ω	0603	Vishay	CRCW06030000Z0EA	1
RVREF	10.5k Ω	0603	Vishay	CRCW060310K5FKEA	1

Table 4. Example for I_{LED} Setting

$R_{IADJ}(\Omega)$	$R_{VREF}(\Omega)$	$I_{LED}(mA)$
499	OPEN	300
SHORT	OPEN	350
SHORT	10.5k	450

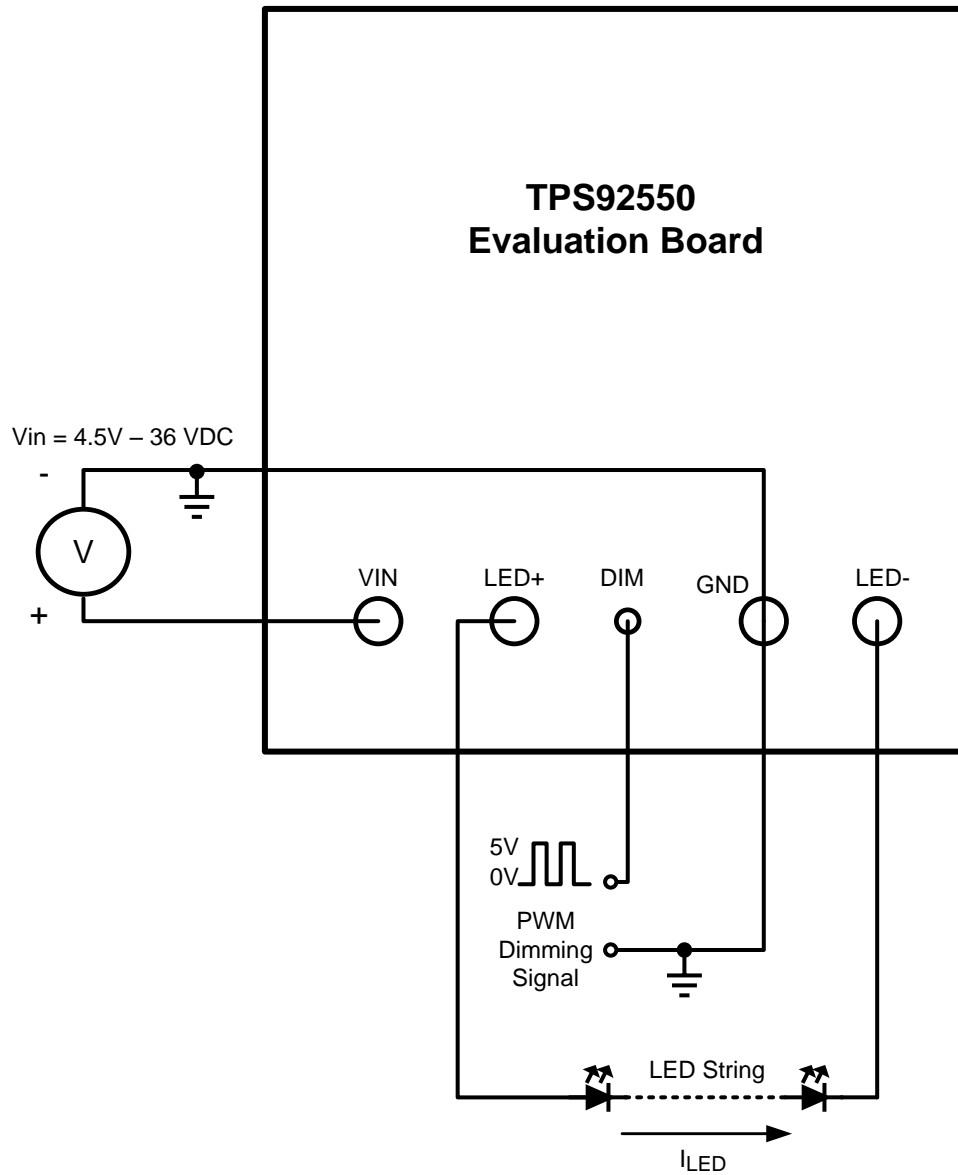
5 Connection Diagram

Figure 4. Connection Diagram Setup

Terminal Designation	Description
VIN	Power Supply positive(+ve) connection
GND	Power supply negative(-ve) connection
LED+	Connect to cathode of the serial LED string
LED-	Connect to anode of the serial LED string
DIM	PWM dimming signal input

6 Typical Performance Characteristics

Unless otherwise specified, the following conditions apply: $V_{IN} = 24V$, C_{IN} is a 2.2 μF 100V X7R ceramic capacitor for driving 2–7 power LEDs with $I_{LED} = 350mA$. Single LED forward voltage used is 3.2V. $T_A = 25^\circ C$ for efficiency curves and waveforms.

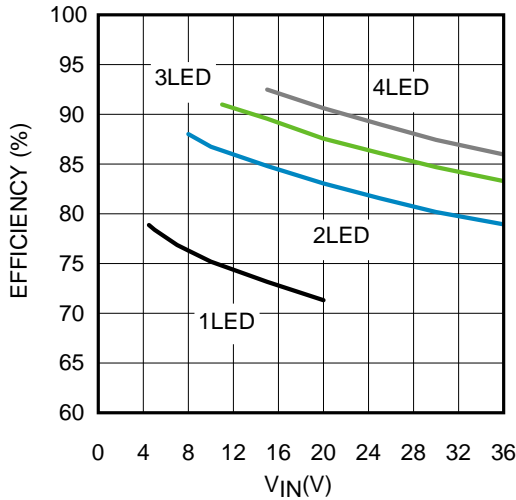

Figure 5. Efficiency vs. V_{IN} ,
 $I_{LED} = 350mA$

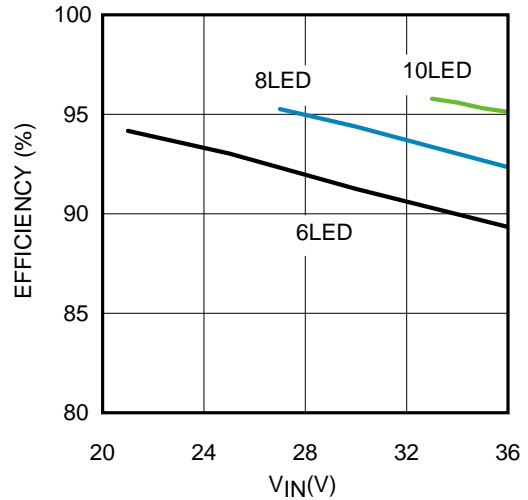

Figure 6. Efficiency vs. V_{IN} ,
 $I_{LED} = 350mA$

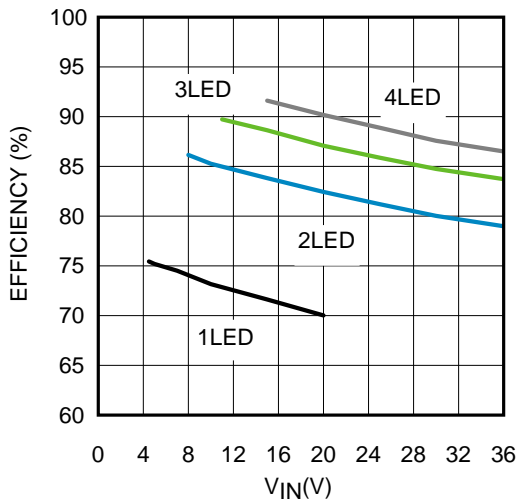

Figure 7. Efficiency vs. V_{IN} ,
 $I_{LED} = 450mA$

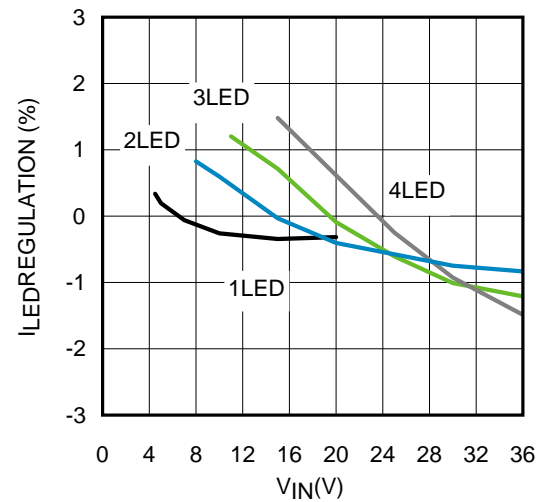

Figure 8. I_{LED} Regulation vs. V_{IN} ,
 $I_{LED} = 350mA$

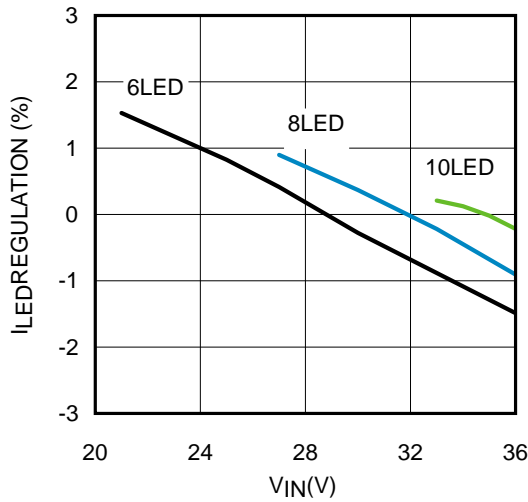

Figure 9. I_{LED} Regulation vs. V_{IN} ,
 $I_{LED} = 350mA$

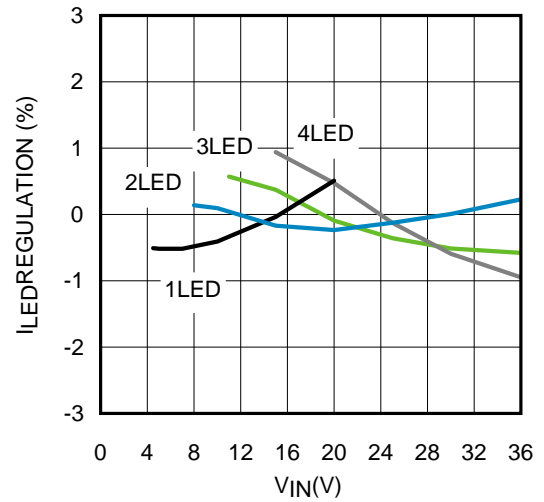

Figure 10. I_{LED} Regulation vs. V_{IN} ,
 $I_{LED} = 450mA$

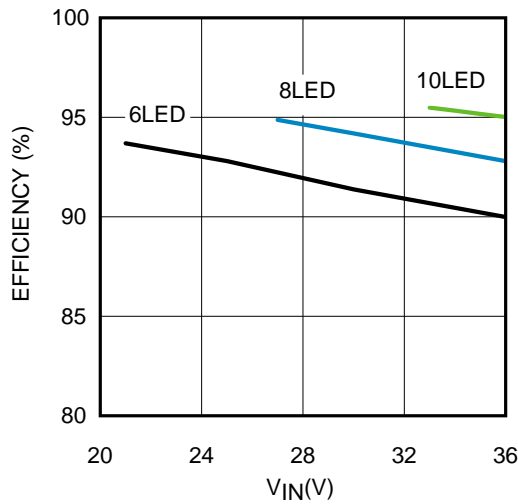

Figure 11. Efficiency vs. V_{IN} ,
 $I_{LED} = 450mA$

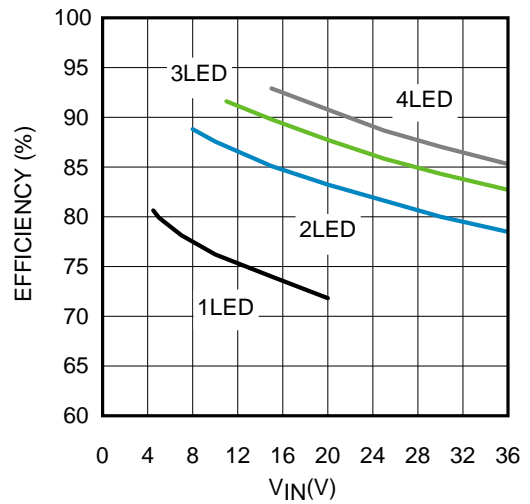
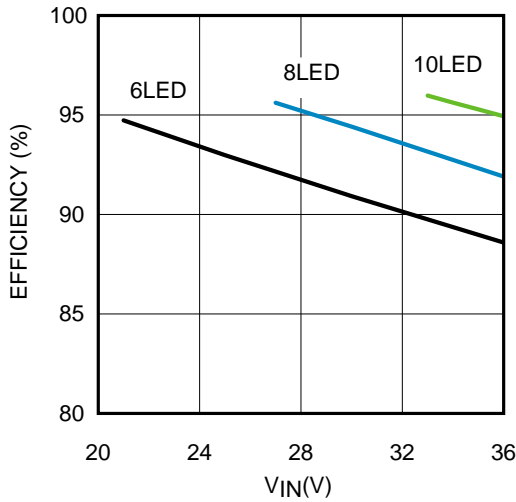
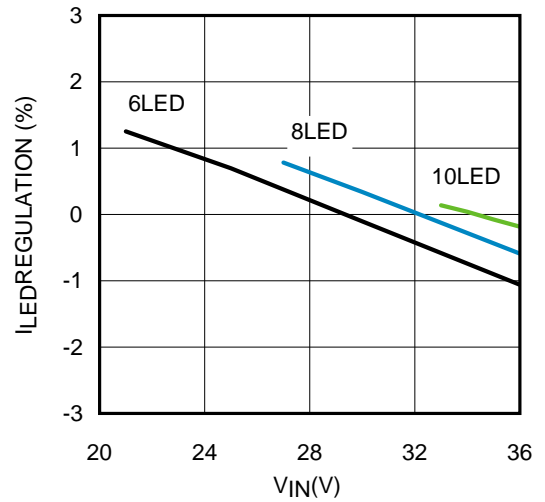

Figure 12. Efficiency vs. V_{IN} ,
 $I_{LED} = 300mA$



**Figure 13. Efficiency vs. V_{IN} ,
 $I_{LED} = 300mA$**



**Figure 14. I_{LED} Regulation vs. V_{IN} ,
 $I_{LED} = 450mA$**

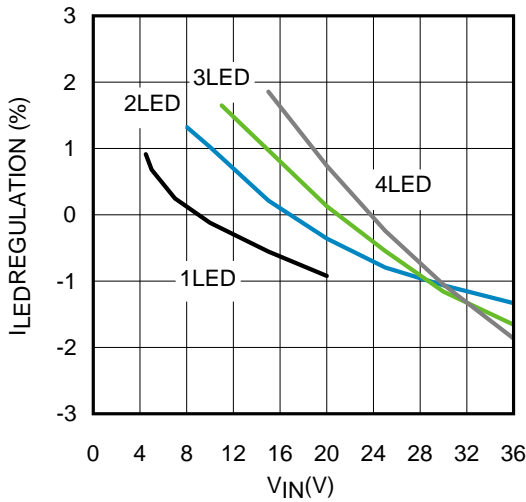

**Figure 15. I_{LED} Regulation vs. V_{IN} ,
 $I_{LED} = 300mA$**

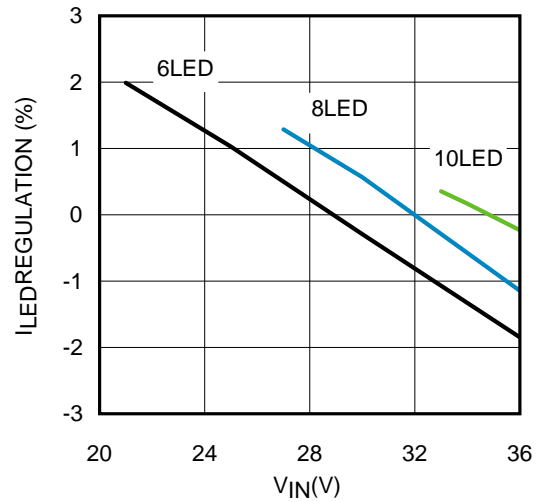

**Figure 16. I_{LED} Regulation vs. V_{IN} ,
 $I_{LED} = 300mA$**

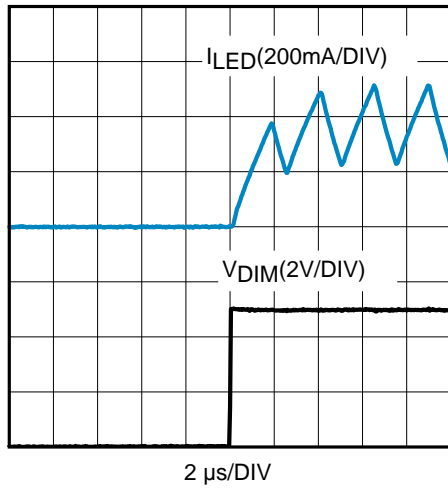

Figure 17. LED Current with PWM Dimming V_{DIM} Rising (without COUT capacitor)

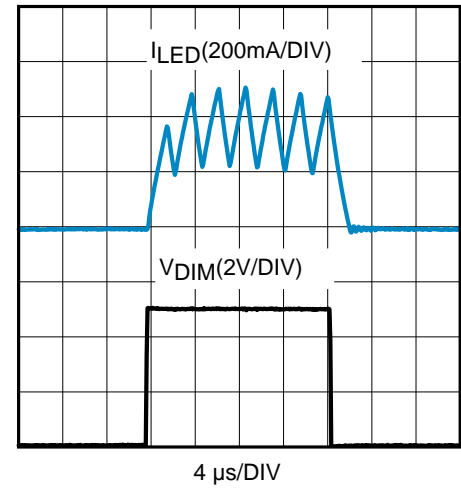

Figure 18. LED Current with PWM Dimming $16\mu s$ dimming pulse (without COUT capacitor)

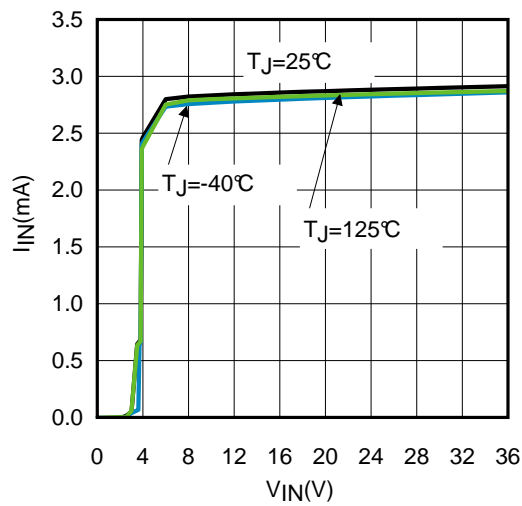

Figure 19. I_{IN} vs. V_{IN} LED = open, DIM = open

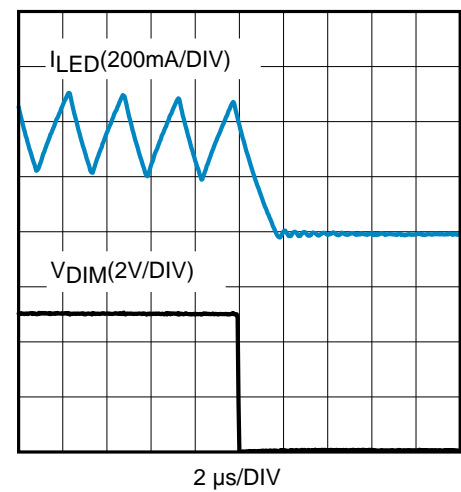

Figure 20. LED Current with PWM Dimming V_{DIM} Falling (without COUT capacitor)

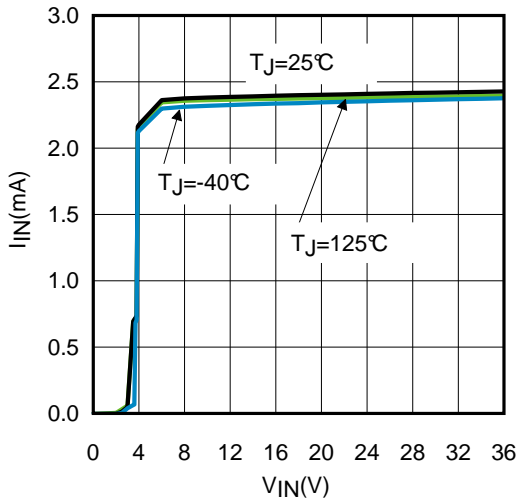

Figure 21. I_{IN} vs. V_{IN}
 $V_{DIM} = 0V$

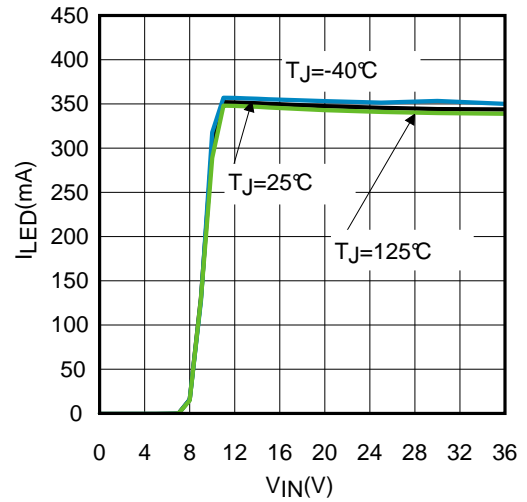

Figure 22. I_{LED} vs. V_{IN}
3LED

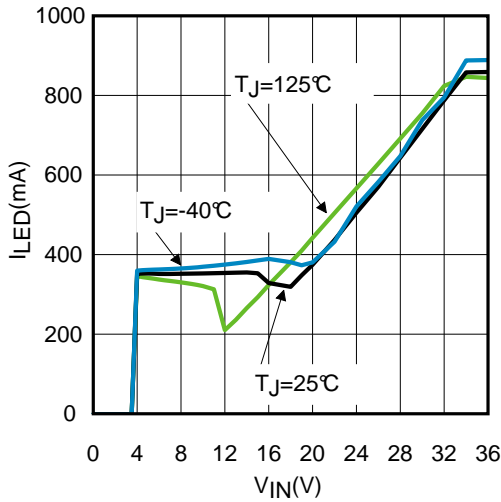

Figure 23. I_{LED} vs. V_{IN}
 $V_{LED} = 0V$, DIM = open

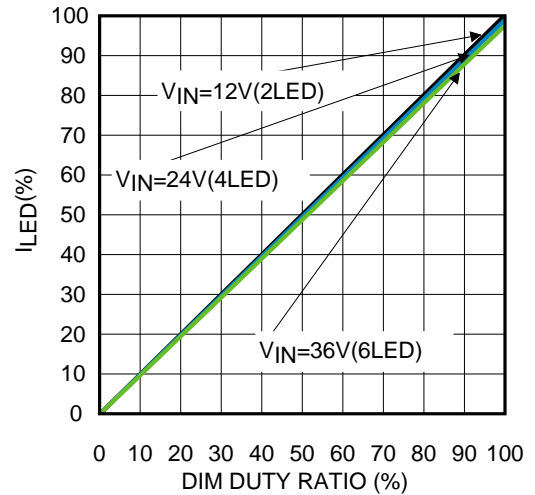

Figure 24. I_{LED} vs. Dimming Duty Ratio

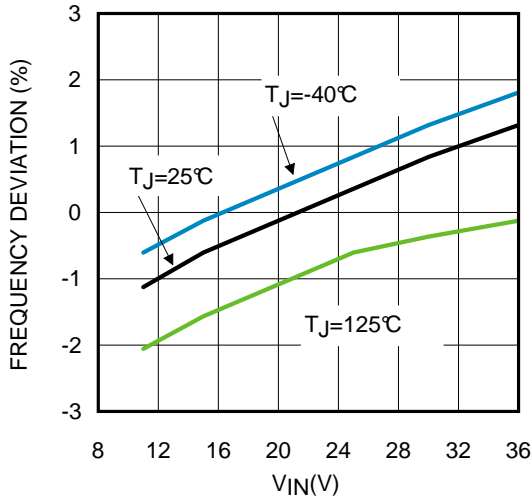

Figure 25. Frequency Deviation vs. V_{IN}
400kHz

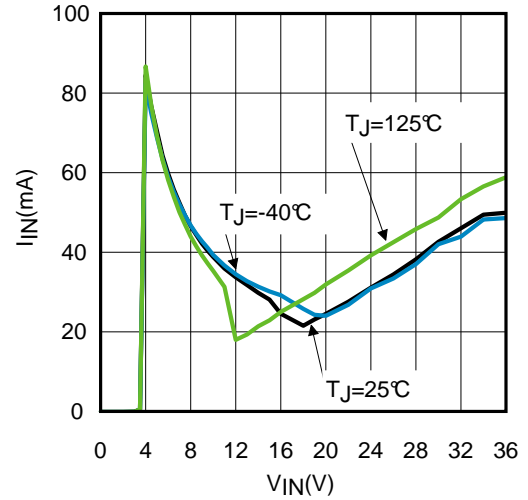

Figure 26. I_{IN} vs. V_{IN}
 $V_{LED} = 0V$, DIM = open

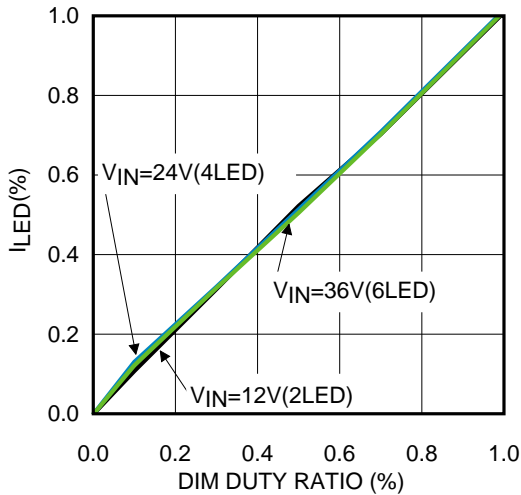

Figure 27. I_{LED} vs. Dimming Duty Ratio

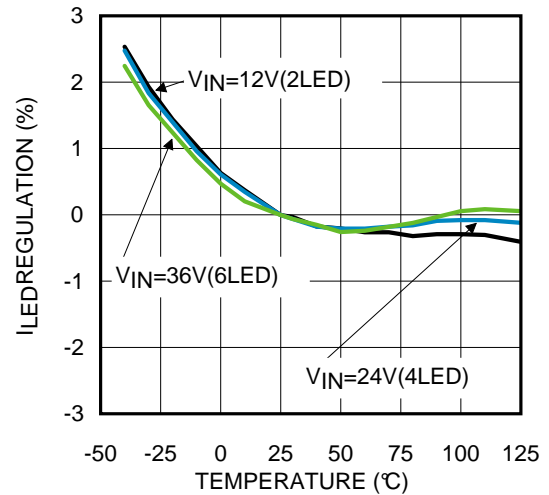

Figure 28. I_{LED} Regulation vs. Temperature

7 Circuit Example 1: Complies with EN55015 Radiated Emissions

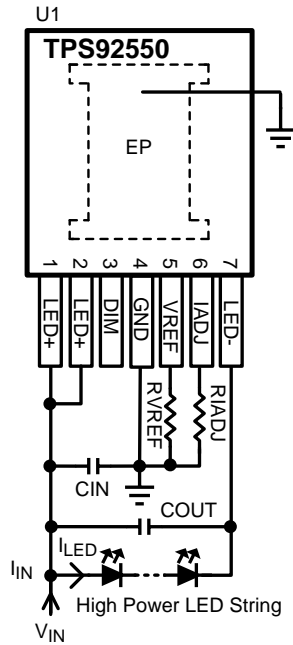

Figure 29. Component Schematic, $V_{IN} = 36V$, $I_{LED} = 300mA$, No. of LED = 10, Complies with EN55015 Radiated Emissions

Table 5. Bill of Materials

Designator	Description	Case Size	Manufacturer	Manufacturer P/N	Quantity
U1	LED Micro-Module Driver	PFM-7	Texas Instruments	TPS92550	1
CIN	2.2 μF , X7R, 100V	1210	Murata	GRM32ER72A225KA35L	1
COUT	2.2 μF , X7R, 100V	1210	Murata	GRM32ER72A225KA35L	1
RIADJ	499 Ω	0603	Vishay	CRCW0603499RFKEA	1
RVREF	No connection	N/A	N/A	N/A	0

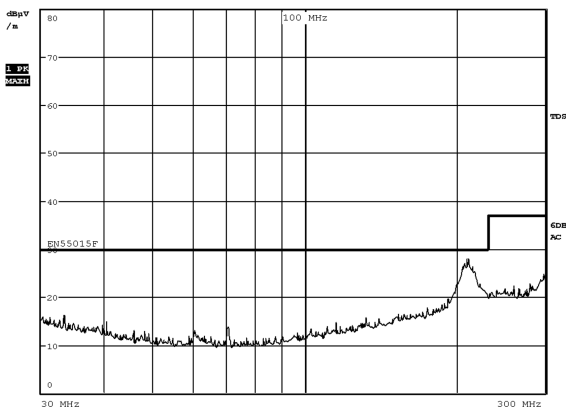

Figure 30. Complies with EN55015 Radiated Emissions
(HORI. / HEIGHT=3.0m / RANGE=10m)
 $V_{IN} = 36V$, $I_{LED} = 300mA$, No. of LED = 10
Tested on TPS92550 Evaluation Board

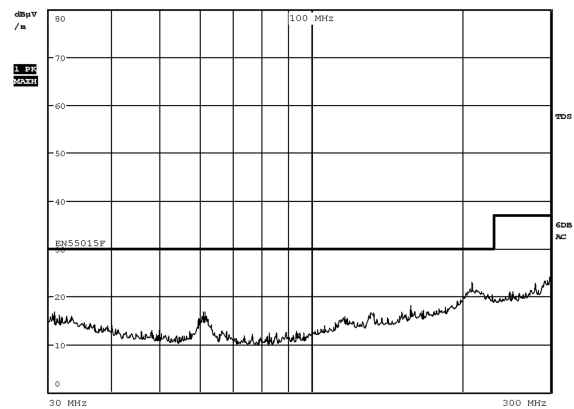

Figure 31. Complies with EN55015 Radiated Emissions
(VERT. / HEIGHT=1.0m / RANGE=10m)
 $V_{IN} = 36V$, $I_{LED} = 300mA$, No. of LED = 10
Tested on TPS92550 Evaluation Board

8 Circuit Example 2: Complies with EN55015 Radiated Emissions

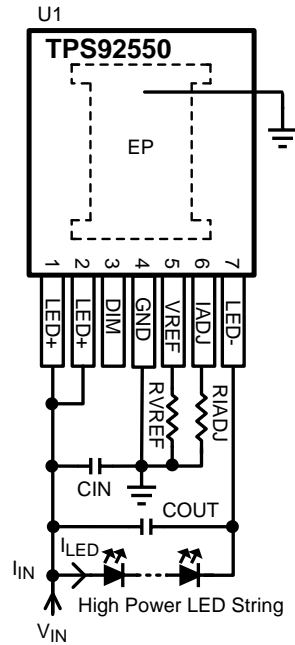

Figure 32. Component Schematic, $V_{IN} = 36V$, $I_{LED} = 350mA$, No. of LED = 10, Complies with EN55015 Radiated Emissions

Table 6. Bill of Materials

Designator	Description	Case Size	Manufacturer	Manufacturer P/N	Quantity
U1	LED Micro-Module Driver	PFM-7	Texas Instruments	TPS92550	1
CIN	2.2 μF , X7R, 100V	1210	Murata	GRM32ER72A225KA35L	1
COUT	2.2 μF , X7R, 100V	1210	Murata	GRM32ER72A225KA35L	1
RIADJ	0 Ω	0603	Vishay	CRCW06030000Z0EA	1
RVREF	No connection	N/A	N/A	N/A	0

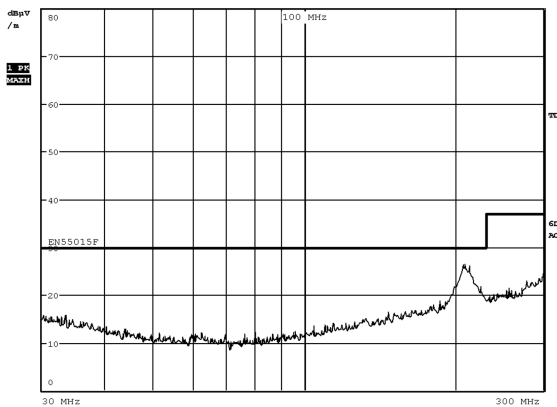

Figure 33. Complies with EN55015 Radiated Emissions
(HORI. / HEIGHT=3.0m / RANGE=10m)
 $V_{IN} = 36V$, $I_{LED} = 350mA$, No. of LED = 10
Tested on TPS92550 Evaluation Board

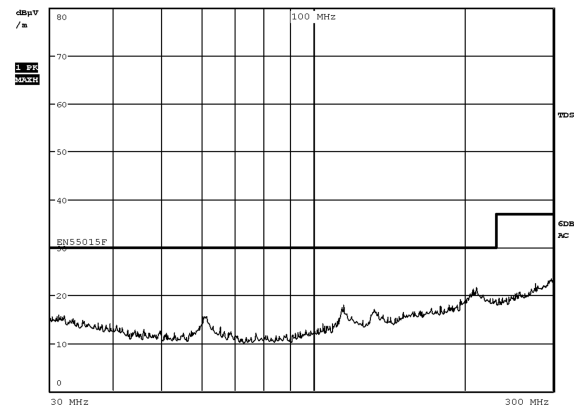

Figure 34. Complies with EN55015 Radiated Emissions
(VERT. / HEIGHT=1.0m / RANGE=10m)
 $V_{IN} = 36V$, $I_{LED} = 350mA$, No. of LED = 10
Tested on TPS92550 Evaluation Board

9 Circuit Example 3: Complies with EN55015 Radiated Emissions

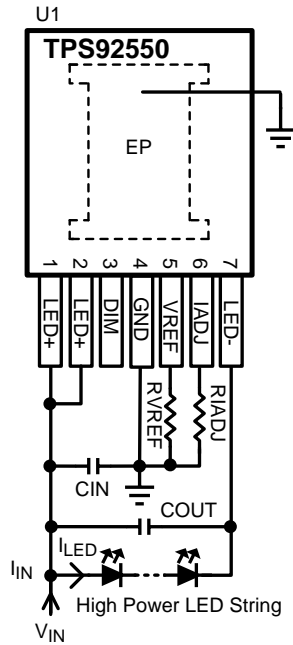

Figure 35. Component Schematic, $V_{IN} = 36V$, $I_{LED} = 450mA$, No. of LED = 10, Complies with EN55015 Radiated Emissions

Table 7. Bill of Materials

Designator	Description	Case Size	Manufacturer	Manufacturer P/N	Quantity
U1	LED Micro-Module Driver	PFM-7	Texas Instruments	TPS92550	1
CIN	2.2 μF , X7R, 100V	1210	Murata	GRM32ER72A225KA35L	1
COUT	2.2 μF , X7R, 100V	1210	Murata	GRM32ER72A225KA35L	1
RIADJ	0 Ω	0603	Vishay	CRCW06030000Z0EA	1
RVREF	10.5k Ω	0603	Vishay	CRCW060310K5FKEA	1

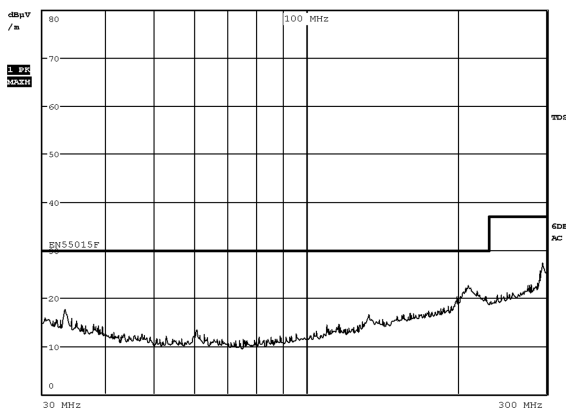

Figure 36. Complies with EN55015 Radiated Emissions
(HORI. / HEIGHT=3.0m / RANGE=10m)
 $V_{IN} = 36V$, $I_{LED} = 450mA$, No. of LED = 10
Tested on TPS92550 Evaluation Board

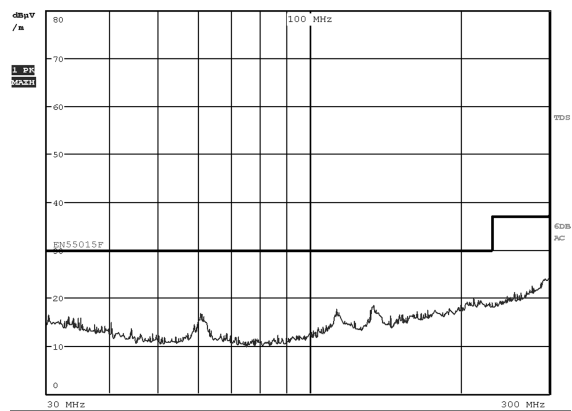

Figure 37. Complies with EN55015 Radiated Emissions
(VERT. / HEIGHT=1.0m / RANGE=10m)
 $V_{IN} = 36V$, $I_{LED} = 450mA$, No. of LED = 10
Tested on TPS92550 Evaluation Board

10 PCB Layout Diagram

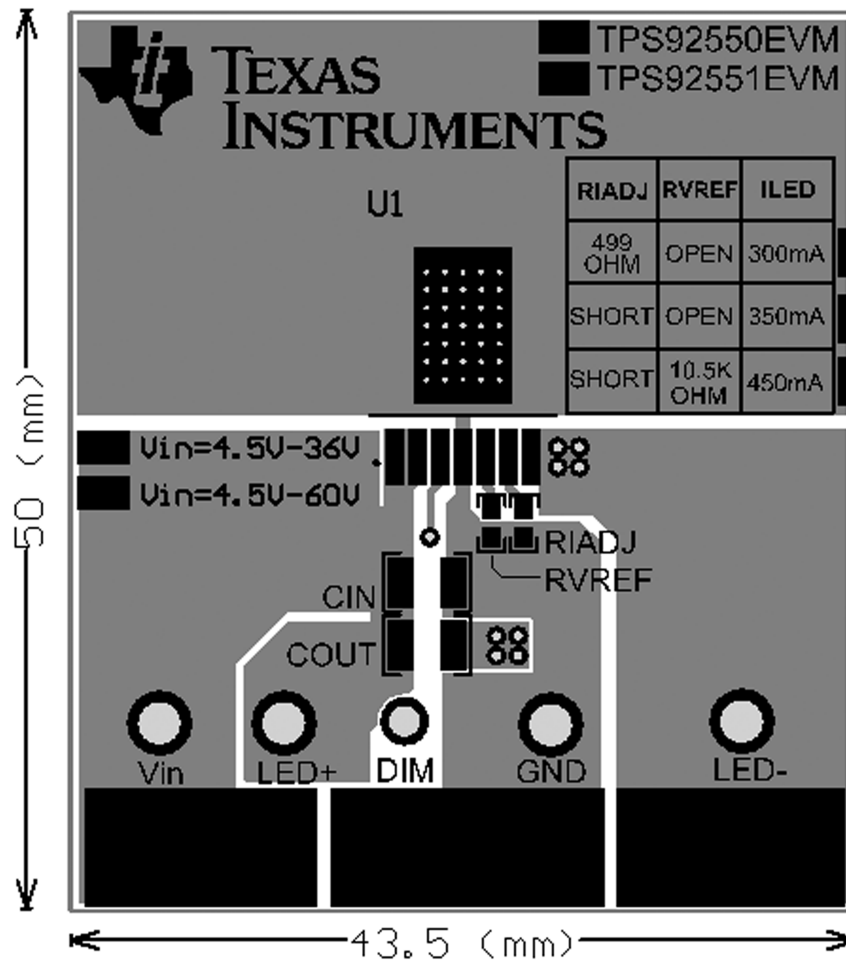

Figure 38. Top Layer and Top Overlay

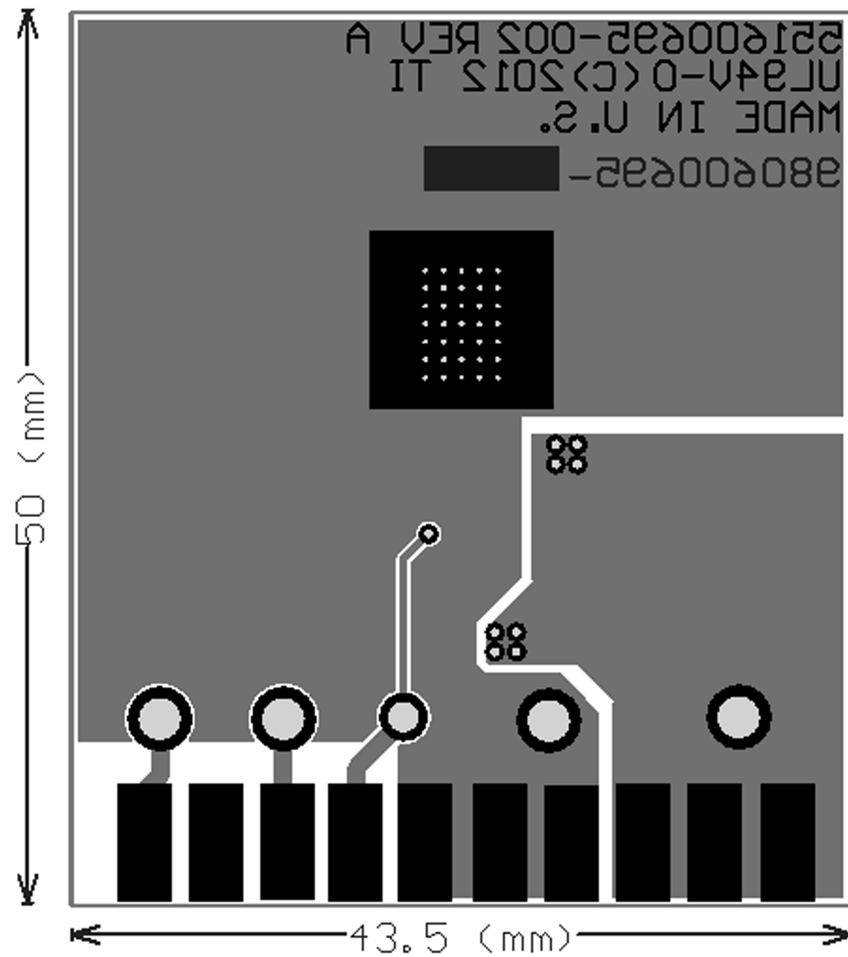

Figure 39. Bottom Layer and Bottom Overlay

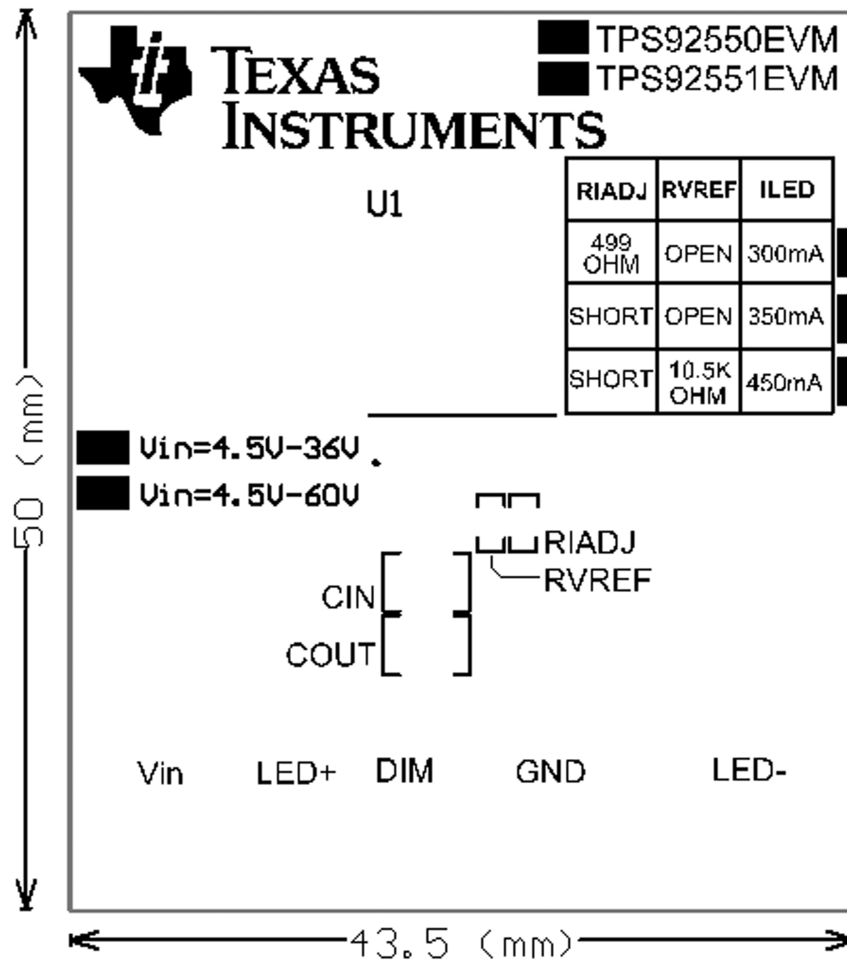

Figure 40. Top Overlay

IMPORTANT NOTICE

Texas Instruments Incorporated and its subsidiaries (TI) reserve the right to make corrections, enhancements, improvements and other changes to its semiconductor products and services per JESD46, latest issue, and to discontinue any product or service per JESD48, latest issue. Buyers should obtain the latest relevant information before placing orders and should verify that such information is current and complete. All semiconductor products (also referred to herein as "components") are sold subject to TI's terms and conditions of sale supplied at the time of order acknowledgment.

TI warrants performance of its components to the specifications applicable at the time of sale, in accordance with the warranty in TI's terms and conditions of sale of semiconductor products. Testing and other quality control techniques are used to the extent TI deems necessary to support this warranty. Except where mandated by applicable law, testing of all parameters of each component is not necessarily performed.

TI assumes no liability for applications assistance or the design of Buyers' products. Buyers are responsible for their products and applications using TI components. To minimize the risks associated with Buyers' products and applications, Buyers should provide adequate design and operating safeguards.

TI does not warrant or represent that any license, either express or implied, is granted under any patent right, copyright, mask work right, or other intellectual property right relating to any combination, machine, or process in which TI components or services are used. Information published by TI regarding third-party products or services does not constitute a license to use such products or services or a warranty or endorsement thereof. Use of such information may require a license from a third party under the patents or other intellectual property of the third party, or a license from TI under the patents or other intellectual property of TI.

Reproduction of significant portions of TI information in TI data books or data sheets is permissible only if reproduction is without alteration and is accompanied by all associated warranties, conditions, limitations, and notices. TI is not responsible or liable for such altered documentation. Information of third parties may be subject to additional restrictions.

Resale of TI components or services with statements different from or beyond the parameters stated by TI for that component or service voids all express and any implied warranties for the associated TI component or service and is an unfair and deceptive business practice. TI is not responsible or liable for any such statements.

Buyer acknowledges and agrees that it is solely responsible for compliance with all legal, regulatory and safety-related requirements concerning its products, and any use of TI components in its applications, notwithstanding any applications-related information or support that may be provided by TI. Buyer represents and agrees that it has all the necessary expertise to create and implement safeguards which anticipate dangerous consequences of failures, monitor failures and their consequences, lessen the likelihood of failures that might cause harm and take appropriate remedial actions. Buyer will fully indemnify TI and its representatives against any damages arising out of the use of any TI components in safety-critical applications.

In some cases, TI components may be promoted specifically to facilitate safety-related applications. With such components, TI's goal is to help enable customers to design and create their own end-product solutions that meet applicable functional safety standards and requirements. Nonetheless, such components are subject to these terms.

No TI components are authorized for use in FDA Class III (or similar life-critical medical equipment) unless authorized officers of the parties have executed a special agreement specifically governing such use.

Only those TI components which TI has specifically designated as military grade or "enhanced plastic" are designed and intended for use in military/aerospace applications or environments. Buyer acknowledges and agrees that any military or aerospace use of TI components which have **not** been so designated is solely at the Buyer's risk, and that Buyer is solely responsible for compliance with all legal and regulatory requirements in connection with such use.

TI has specifically designated certain components as meeting ISO/TS16949 requirements, mainly for automotive use. In any case of use of non-designated products, TI will not be responsible for any failure to meet ISO/TS16949.

Products

Audio	www.ti.com/audio
Amplifiers	amplifier.ti.com
Data Converters	dataconverter.ti.com
DLP® Products	www.dlp.com
DSP	dsp.ti.com
Clocks and Timers	www.ti.com/clocks
Interface	interface.ti.com
Logic	logic.ti.com
Power Mgmt	power.ti.com
Microcontrollers	microcontroller.ti.com
RFID	www.ti-rfid.com
OMAP Applications Processors	www.ti.com/omap
Wireless Connectivity	www.ti.com/wirelessconnectivity

Applications

Automotive and Transportation	www.ti.com/automotive
Communications and Telecom	www.ti.com/communications
Computers and Peripherals	www.ti.com/computers
Consumer Electronics	www.ti.com/consumer-apps
Energy and Lighting	www.ti.com/energy
Industrial	www.ti.com/industrial
Medical	www.ti.com/medical
Security	www.ti.com/security
Space, Avionics and Defense	www.ti.com/space-avionics-defense
Video and Imaging	www.ti.com/video

TI E2E Community

e2e.ti.com