

Z83

2MP Outdoor Zoom Dome with D/N, Adaptive IR, Superior WDR, SLLS, 4.3x Zoom Lens



- 2 Megapixel
- Day & Night with Superior Low Light Sensitivity and Adaptive IR LED
- 4.3x Zoom Lens with f2.8-12/F1.6, Auto focus (for installation)
- Superior WDR
- H.265 Compression
- Super wide angle
- Event trigger, response and notification

► Specifications

Device

| | |
|--------------------------|--|
| Product Type | Zoom Dome |
| Maximum Resolution | 2MP |
| Application Environment | Outdoor |
| Image Sensor | Progressive Scan CMOS |
| Sensor Size | 1/2.7 " |
| Day / Night | Yes |
| Low Light Sensitivity | Superior |
| Minimum Illumination | Color: 0.01 lux; B/W: 0 lux (IR LED on) |
| Mechanical IR Cut Filter | Yes |
| IR LED | Adaptive IR LED |
| IR Working Distance | 40m |
| Electronic Shutter | 1-1/100000 second (manual mode); 1-1/100000 second (auto mode) |
| S/N Ratio | 52 dB |

Lens

| | |
|--------------|-----------------|
| Focal Length | Zoom, f2.8-12mm |
|--------------|-----------------|

| | |
|--------------------------|---|
| Aperture | F1.6 |
| Zoom Ratio | 4.3x optical zoom |
| Zoom Application | Camera Installation |
| Iris | Fixed iris |
| Focus | Auto focus |
| Lens Mount | Board mount |
| Horizontal Viewing Angle | 110.3° - 30.5° |
| Vertical Viewing Angle | 56.4° - 17.2° |
| Viewing Angle Adjustment | Pan: 0°-360°, Tilt: 0°-80°, Rotation: 0°-360° |

Video

| | |
|-----------------------------------|---|
| Compression | H.265, H.264 (Baseline/ Main profile), MJPEG |
| Maximum Frame Rate vs. Resolution | 30 fps at 1920 x 1080 30 fps at 1280 x 720 30 fps at 704 x 576 30 fps at 704 x 288 30 fps at 640 x 360 30 fps at 352 x 288 |
| Multi-Streaming | Simultaneous triple streams |
| Bit Rate Mode | Constant, Variable |
| Wide Dynamic Range | Superior WDR (120 dB) |
| Image Enhancement | White Balance, Backlight compensation (BLC), Brightness, Contrast, Sharpness, Automatic gain control, Defogging |
| Digital Noise Reduction | 2D + 3D DNR |
| Privacy Mask | 4 configurable regions |
| Text Overlay | Yes |
| Built-in Analytics | Tampering Detection, Intrusion Detection (Forbidden Area Detection)* |
| Server-based Analytics | Object Line Counting, People Counting, Face Detection, Object Based Motion Detection, Tamper, Object Line Crossing Detection, Object Enter Area Detection, Missing Object Detection, Unattended Object Detection, Smoke Detection, Heat Map, Dwell Time, Direction Detection, Automatic License Plate Recognition, People Queue Detection, (Require PC-based or standalone IVS or ALPR Server. Contact ACTi support for recommendations on how to maximize analytical accuracy) |
| Image Orientation | Flip, Mirror |

Network

| | |
|----------------------------|--|
| Network Protocol & Service | IPv4, TCP, UDP, DHCP, HTTP, HTTPS, DNS, DDNS, NTP, RTP, RTSP, RTCP, SMTP, FTP, IGMP, ICMP, ARP, UPnP, QoS, SSL/TLS |
| Ethernet Port | 1 x Ethernet (10/100 Base-T), RJ-45 pigtail connector |
| Security | IP address filtering, HTTPS encryption, Password protected user level |

Event

| | |
|----------------|--|
| Event Trigger | Video motion detection (4 regions), Intelligent event detection. |
| Event Response | E-mail notification with snapshots, Upload snapshot to FTP server, Save video or snapshot to local storage |

Integration

| | |
|-----------------|--------------------------------------|
| ONVIF Compliant | Yes, Profile S, Profile G, Profile T |
|-----------------|--------------------------------------|

| | |
|-------------|-------|
| Web Browser | IE 11 |
|-------------|-------|

Interface

| | |
|------------------|---|
| Local Storage | MicroSD Memory Card Slot (card not included, up to 256GB, Kingston or Sandisk only) |
| Operating Button | Reset Button |

General

| | |
|-----------------------|--|
| Power Source | DC 12V, PoE Class 3 (IEEE802.3af) |
| Power Consumption | 6.5 W (PoE) |
| Weight | 909g (2.004lb) |
| Dimensions | (Ø x H): 148mm x 111mm (5.8" x 4.4") |
| Environmental Casing | Weatherproof (IP68), Vandal proof (IK10) |
| Operating Temperature | -40°C ~ 60°C (-40°F ~ 140°F) |
| Approvals | CE Class B, FCC Class B, BIS, EAC, IP68, IK10 |
| Warranty | 2 Year(s). For extended warranty offering, see http://www.acti.com/support/warranty |

► Photo Indication



- 1 DC 12V Power Input
- 2 Ethernet Port
- 3 Reset Button
- 4 Memory Card Slot

► Dimension Diagram

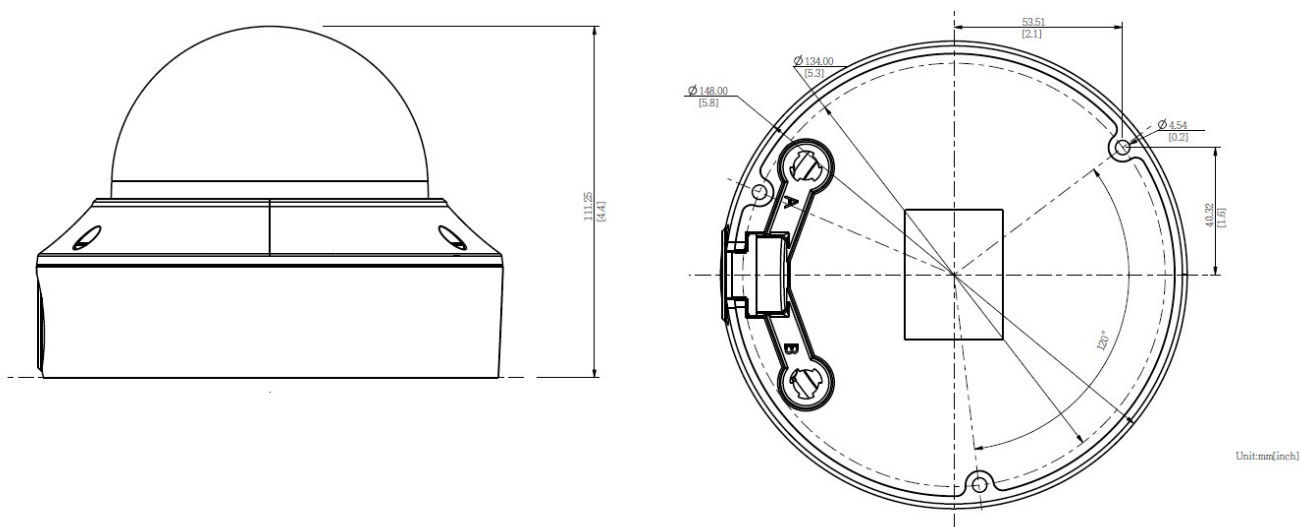

















Unit:mm[inch]

Unit: mm [inch]

► Related Products

Mounting Accessories - Camera Mount

| | | |
|-----------|---|--|
| PMAX-0102 |  | Straight Tube |
| PMAX-0103 |  | Straight Tube with Bracket |
| PMAX-0104 |  | Extension Tube |
| PMAX-0127 |  | Mount Kit (for Z83, Z84, A811, A818) |
| PMAX-0302 |  | Gooseneck with Bracket |
| PMAX-0303 |  | Gooseneck |
| PMAX-0321 |  | Heavy Duty Wall Mount for Outdoor Domes (for A8x, Z83, Z84, except A88) |
| PMAX-0352 |  | Wall Mount with Built-in Junction Box (for Z83, Z84, Z810) |
| PMAX-0402 |  | Corner Mount |
| PMAX-0503 |  | Pole Mount (for PMAX-0102, PMAX-0312, PMAX-0313, PMAX-0314, PMAX-0702, PMAX-1106, PMAX-1107), supports 5.25" to 8.5" Poles |
| PMAX-0505 |  | Pole Mount (for B4x, B41x, E44, E45, E46, E48, E44A, E45A, E46A, E41x, I4x, PMAX-0312, PMAX-0313, PMAX-0314, PMAX-0330), supports 2" to 3" Poles |
| PMAX-0527 |  | Pole Mount (for Z4x, Z710, Z8x, Z9x, A7x), supports 2.64" to 5" Poles |
| PMAX-0702 |  | Junction Box for PTZ and Dome Cameras |
| PMAX-0723 |  | Junction Box (for Z83, Z84) |
| PMAX-0808 |  | Converter Ring, 1.5" NPT for Third-Party Mounting Accessories |
| PMAX-1031 |  | Flush Mount (for Z83, Z84) |

Note: Some mounting accessories may need additional accessories for installation. Please check www.acti.com/mountingselector for more information.

Power Supply Accessories - Power Adapter

| | | |
|-----------|---|---|
| PPBX-0012 |  | Power Adapter AC 100~240V (US), for A3x, A4x, A88, A9x, Z31, Z8x, Z9x |
|-----------|---|---|

PPBX-0013



Power Adapter AC 100~240V (EU), for A3x, A4x, A88, A9x, Z31, Z8x, Z9x

PPBX-0014



Power Adapter AC 100~240V (UK), for A3x, A4x, A88, A9x, Z31, Z8x, Z9x

Power Supply Accessories - PoE Injector

PPOE-0002



PoE Injector IEEE 802.3af compliant, AC 100~240V, with universal connectors