

1 Form A Solid-State Relay

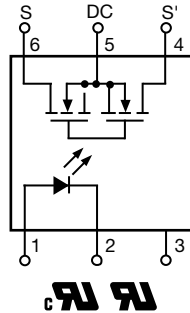

FEATURES

- High speed SSR - $t_{on}/t_{off} < 800 \mu s$
- Maximum $R_{ON} 0.25 \Omega$
- Isolation test voltage $5300 V_{RMS}$
- Load voltage 60 V
- Load current 2 A_{DC} configuration
- DIP-6 package
- Clean bounce free switching
- TTL / CMOS compatible input
- Available on tape and reel
- Material categorization: for definitions of compliance please see www.vishay.com/doc?99912

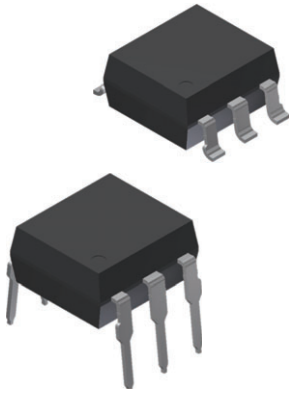

RoHS
COMPLIANT

DESCRIPTION

The VO14642 is a high speed single channel normally open solid-state relay (SPST - 1 form A) in a DIP-6 package. The relay is constructed as a multi-chip hybrid device. A high efficient infrared LED enables low forward current on the input side. On the output side high performance MOSFET switches provide a low R_{ON} and can be configured for AC/DC or DC only operation.

APPLICATIONS

- Instrumentation
- Industrial controls
- Security
- Automatic measurement equipment

AGENCY APPROVALS

- UL1577
- cUL - UL1577
- DIN EN 60747-5-5 (VDE 0884-5) capable, consult sales representative for details

Note

- Agency approvals are valid only for ambient temperature range -40 °C to 85 °C

ORDERING INFORMATION													
V	O	1	4	6	4	2	A	x	x	T	R		
PART NUMBER							ELECTR. VARIATION	PACKAGE CONFIG.	TAPE AND REEL				
PACKAGE													
SMD-6, tape and reel										VO14642AABTR			
DIP-6, Tubes										VO14642AT			



ABSOLUTE MAXIMUM RATINGS (T _{amb} = 25 °C, unless otherwise specified)				
PARAMETER	TEST CONDITION	SYMBOL	VALUE	UNIT
INPUT				
LED continuous forward current		I _F	50	mA
LED reverse voltage		V _R	5	V
LED power dissipation	At 25 °C	P _{diss}	80	mW
OUTPUT				
DC or peak AC load voltage		V _L	60	V
Load current (DC only)		I _L	2	A
Peak load current (AC/DC)	t = 10 ms	I _{LPK}	3.6	A
Output power dissipation	At 25 °C	P _{diss}	250	mW
SSR				
Total power dissipation		P _{diss}	330	mW
Ambient temperature range		T _{amb}	-55 to +85	°C
Storage temperature range		T _{stg}	-55 to +125	°C
Soldering temperature (1)	t ≤ 10 s max.	T _{slid}	260	°C

Notes

- Stresses in excess of the absolute maximum ratings can cause permanent damage to the device. Functional operation of the device is not implied at these or any other conditions in excess of those given in the operational sections of this document. Exposure to absolute maximum ratings for extended periods of the time can adversely affect reliability
- (1) Refer to reflow profile for soldering conditions for surface mounted devices (SMD). Refer to wave profile for soldering conditions for through hole devices (DIP)

ABSOLUTE MAXIMUM RATING CURVE

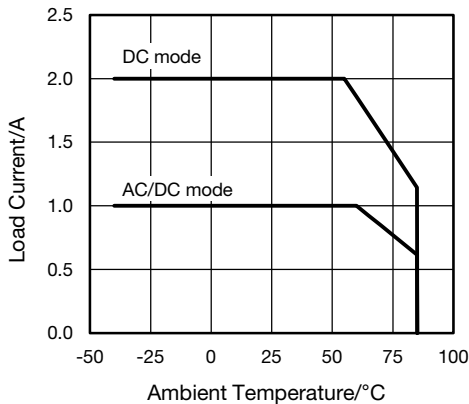
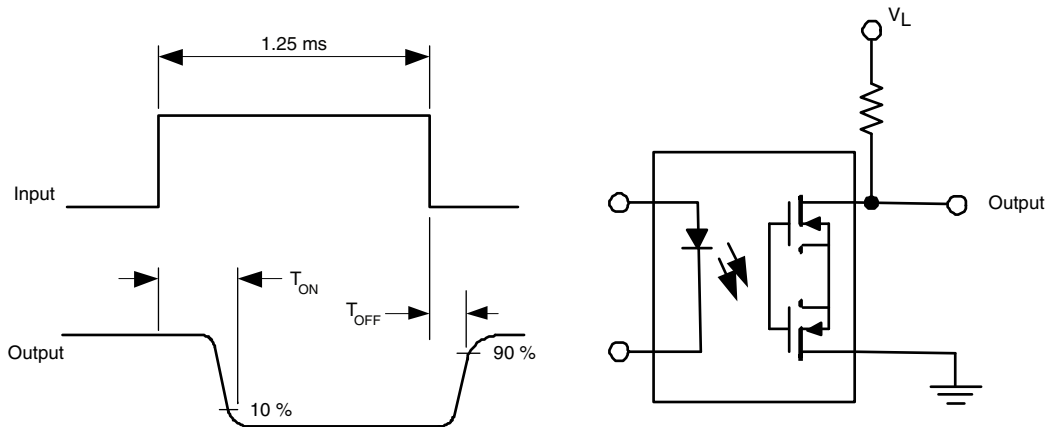

Fig. 1 - Load Current (AC/DC) vs. Temperature

THERMAL CHARACTERISTICS				
PARAMETER	TEST CONDITION	SYMBOL	VALUE	UNIT
Maximum LED junction temperature	At 25 °C	T _{jmax.}	125	°C
Maximum output die junction temperature	At 25 °C	T _{jmax.}	125	°C
Thermal resistance, junction emitter to board	At 25 °C	θ _{EB}	176	°C/W
Thermal resistance, junction emitter to case	At 25 °C	θ _{EC}	208	°C/W
Thermal resistance, junction detector to board	At 25 °C	θ _{DB}	67	°C/W
Thermal resistance, junction detector to case	At 25 °C	θ _{DC}	134	°C/W
Thermal resistance, junction emitter to junction detector	At 25 °C	θ _{ED}	310	°C/W
Thermal resistance, case to ambient	At 25 °C	θ _{CA}	2180	°C/W

Note

- The thermal model is represented in the thermal network below. Each resistance value given in this model can be used to calculate the temperatures at each node for a given operating condition. The thermal resistance from board to ambient will be dependent on the type of PCB, layout and thickness of copper traces. For a detailed explanation of the thermal model, please reference Vishay's thermal characteristics of optocouplers application note



20991-1

SAFETY AND INSULATION RATINGS				
PARAMETER	TEST CONDITION	SYMBOL	VALUE	UNIT
Climatic classification	According to IEC 68 part 1		40 / 085 / 21	
Pollution degree	According to DIN VDE 0109		2	
Comparative tracking index	Insulation group IIIa	CTI	175	
Maximum rated withstanding isolation voltage	According to UL1577, t = 1 min	V_{ISO}	5300	V_{RMS}
Maximum transient isolation voltage	According to DIN EN 60747-5-5	V_{IOTM}	8000	V_{peak}
Maximum repetitive peak isolation voltage	According to DIN EN 60747-5-5	V_{IORM}	890	V_{peak}
Isolation resistance	$T_{amb} = 25\text{ }^{\circ}\text{C}$, $V_{IO} = 500\text{ V}$	R_{IO}	$\geq 10^{12}$	Ω
	$T_{amb} = 100\text{ }^{\circ}\text{C}$, $V_{IO} = 500\text{ V}$	R_{IO}	$\geq 10^{11}$	Ω
	$T_{amb} = T_S$, $V_{IO} = 500\text{ V}$	R_{IO}	$\geq 10^9$	Ω
Output safety power		P_{SO}	400	mW
Input safety current		I_{SI}	150	mA
Input safety temperature		T_S	165	$^{\circ}\text{C}$
Creepage distance			≥ 7	mm
Clearance distance			≥ 7	mm
Insulation thickness		DTI	≥ 0.4	mm

Note

- This SSR is suitable for "safe electrical insulation" only within the safety ratings. Compliance with the safety ratings shall be ensured by means of protective circuits

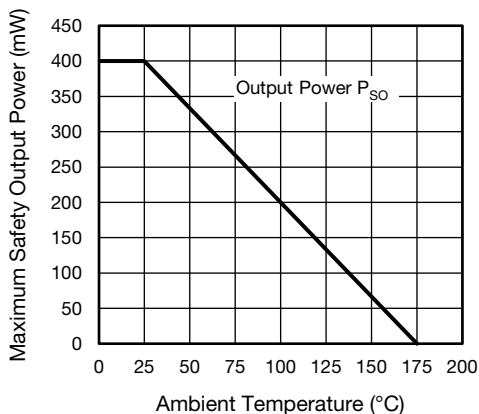

Fig. 2 - Safety Derating (input)

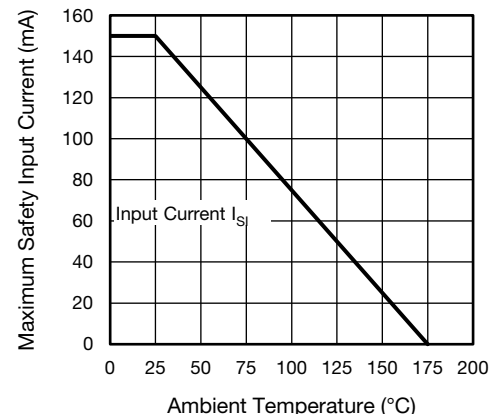

Fig. 3 - Safety Derating (output)

TYPICAL CHARACTERISTICS ($T_{amb} = 25\text{ }^{\circ}\text{C}$, unless otherwise specified)

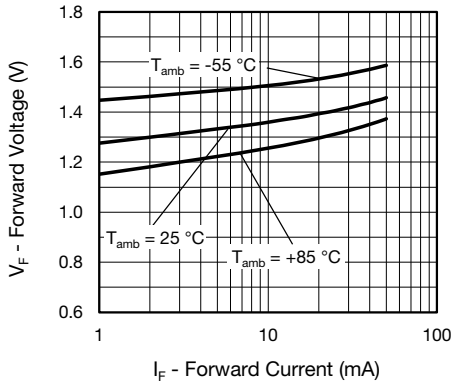

Fig. 4 - Forward Voltage vs. Forward Current

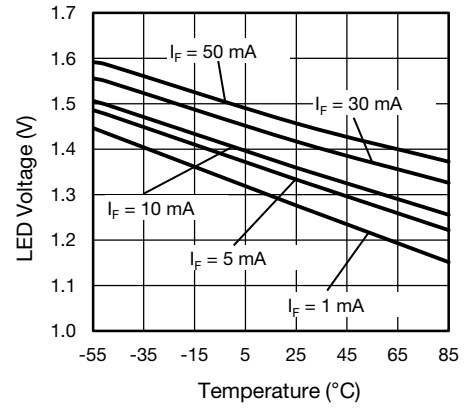

Fig. 7 - LED Voltage vs. Temperature

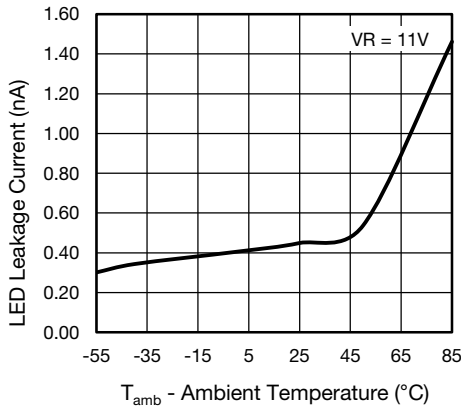

Fig. 5 - LED Leakage Current vs. Ambient Temperature

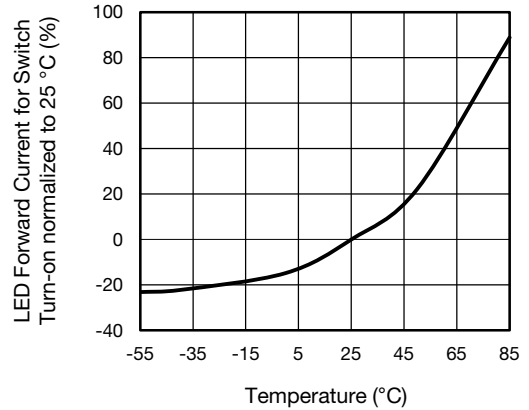

Fig. 8 - LED Forward Current for Switch Turn-On vs. Temperature

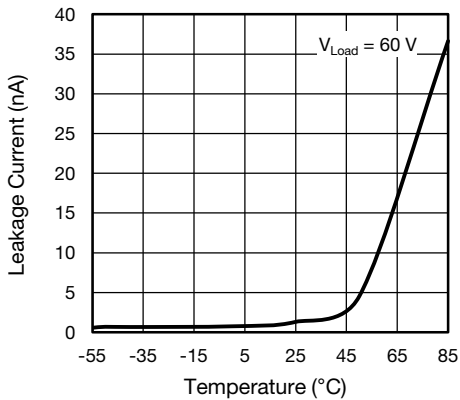

Fig. 6 - Leakage Current vs. Temperature

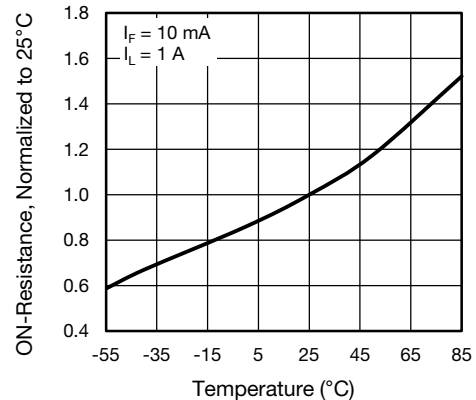

Fig. 9 - On-Resistance vs. Temperature

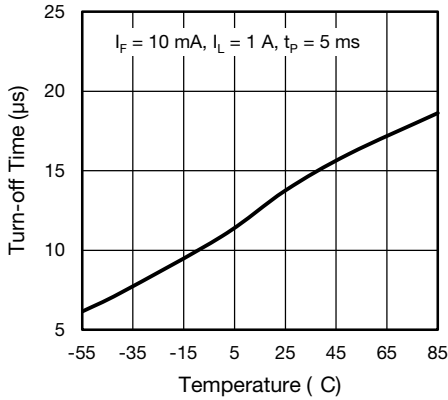

Fig. 10 - Turn-Off Time vs. Temperature

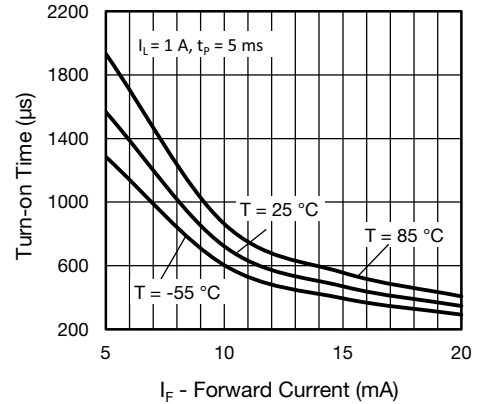

Fig. 13 - Turn-On Time vs. Forward Current

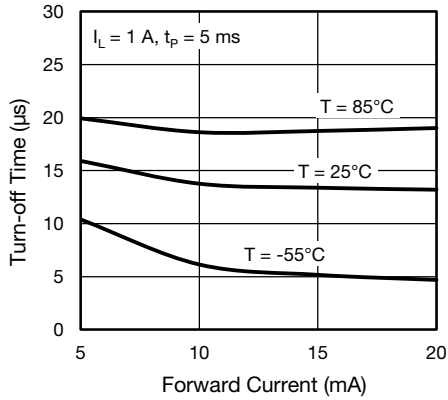

Fig. 11 - Turn-Off Time vs. Forward Current

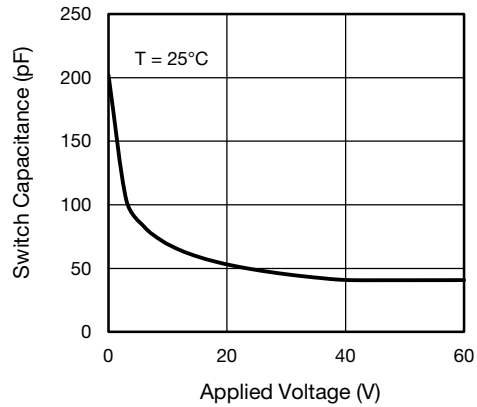

Fig. 14 - Switch Capacitance vs. Applied Voltage

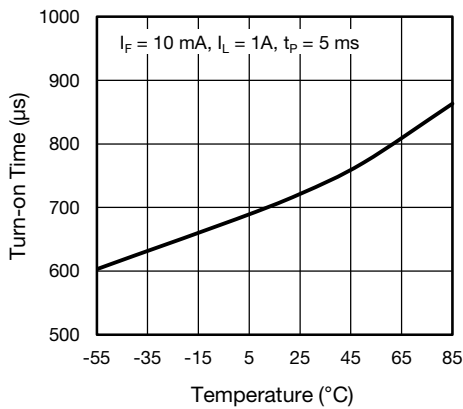
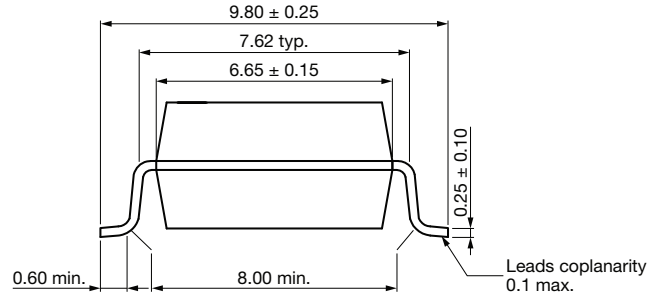
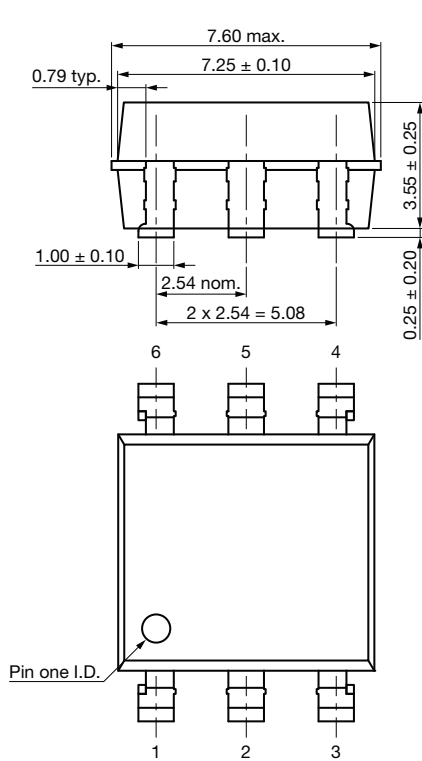

Fig. 12 - Turn-On Time vs. Temperature



PACKAGE DIMENSIONS (in millimeters)

SMD-6



Recommended footprint

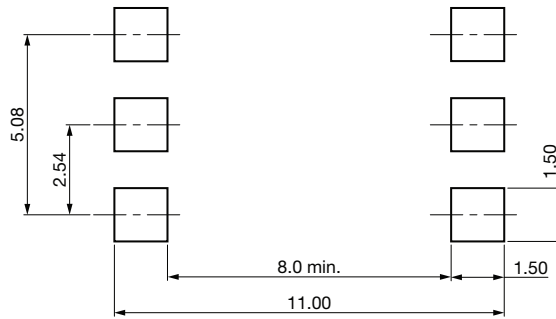

DIP-6

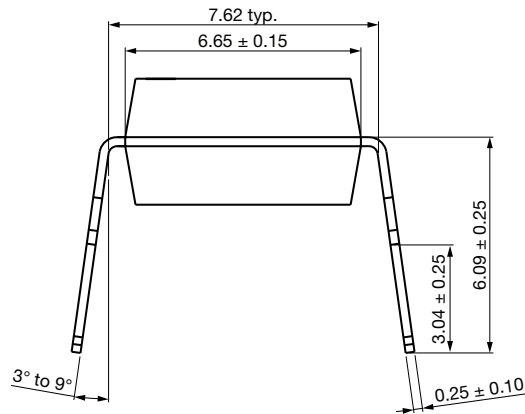
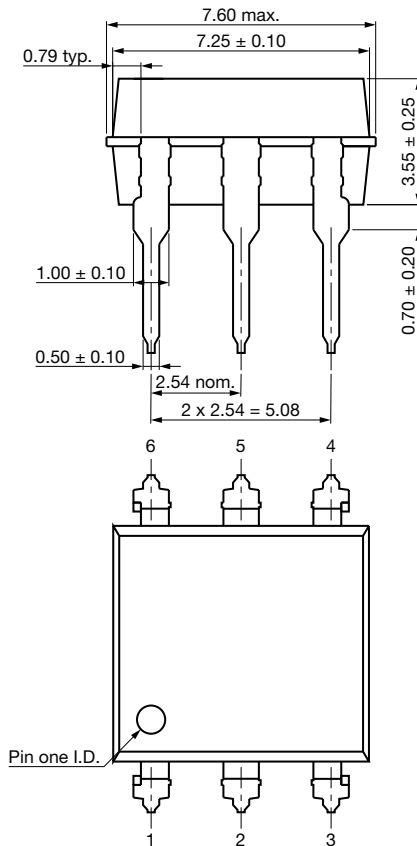

PACKAGE MARKING

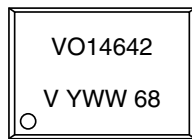

Note

- Tape and reel suffix "TR" is not part of the package marking

PACKING INFORMATION (in millimeters)

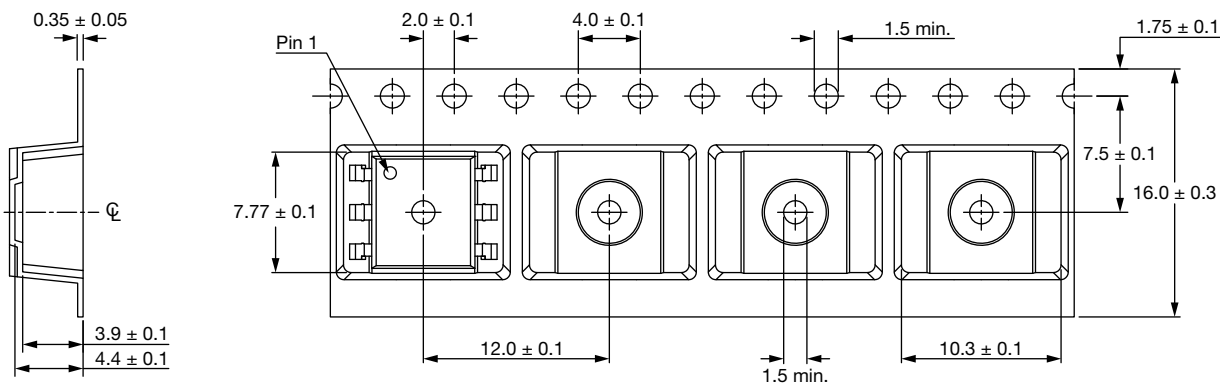

Fig. 15 - Tape and Reel Packing

TAPE AND REEL PACKING	
TYPE	UNITS/REEL
SMD-6	1000

TUBE PACKING			
TYPE	UNITS/TUBE	TUBES/BOX	UNITS/BOX
DIP-6	50	40	2000

SOLDER PROFILES

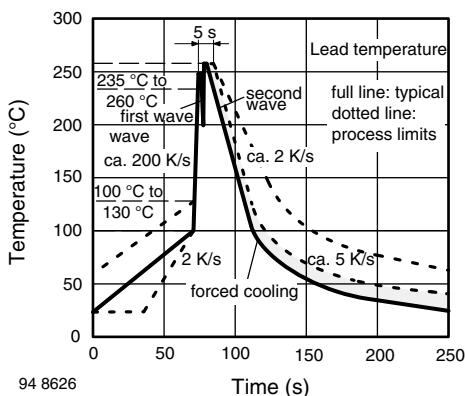

Fig. 16 - Wave Soldering Double Wave Profile According to J-STD-020 for DIP Devices

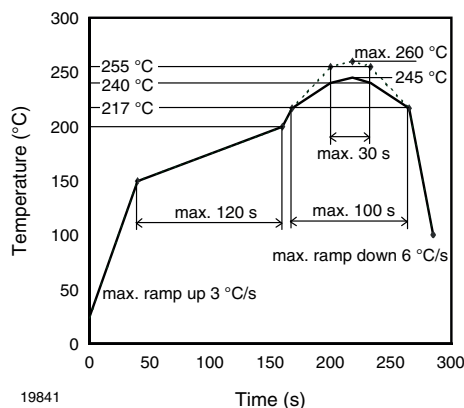

Fig. 17 - Lead (Pb)-free Reflow Solder Profile According to J-STD-020 for SMD Devices

HANDLING AND STORAGE CONDITIONS

ESD level: HBM class 2
 Floor life: unlimited
 Conditions: T_{amb} < 30 °C, RH < 85 %
 Moisture sensitivity level 1, according to J-STD-020



Footprint and Schematic Information for VO14642AAB, VO14642AT

The footprint and schematic symbols for the following parts can be accessed using the associated links. They are available in Eagle, Altium, KiCad, OrCAD / Allegro, Pulsonix, and PADS.

Note that the 3D models for these parts can be found on the Vishay product page.

PART NUMBER	FOOTPRINT / SCHEMATIC
VO14642AAB	www.snapeda.com/parts/VO14642AAB/Vishay/view-part
VO14642AT	www.snapeda.com/parts/VO14642AT/Vishay/view-part

For technical issues and product support, please contact optocoupleranswers@vishay.com.

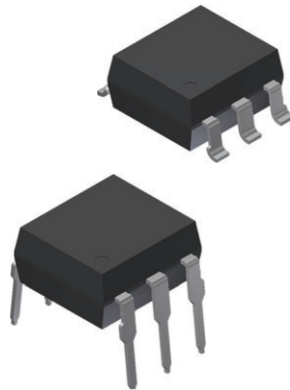



Disclaimer

ALL PRODUCT, PRODUCT SPECIFICATIONS AND DATA ARE SUBJECT TO CHANGE WITHOUT NOTICE TO IMPROVE RELIABILITY, FUNCTION OR DESIGN OR OTHERWISE.

Vishay Intertechnology, Inc., its affiliates, agents, and employees, and all persons acting on its or their behalf (collectively, "Vishay"), disclaim any and all liability for any errors, inaccuracies or incompleteness contained in any datasheet or in any other disclosure relating to any product.

Vishay makes no warranty, representation or guarantee regarding the suitability of the products for any particular purpose or the continuing production of any product. To the maximum extent permitted by applicable law, Vishay disclaims (i) any and all liability arising out of the application or use of any product, (ii) any and all liability, including without limitation special, consequential or incidental damages, and (iii) any and all implied warranties, including warranties of fitness for particular purpose, non-infringement and merchantability.

Statements regarding the suitability of products for certain types of applications are based on Vishay's knowledge of typical requirements that are often placed on Vishay products in generic applications. Such statements are not binding statements about the suitability of products for a particular application. It is the customer's responsibility to validate that a particular product with the properties described in the product specification is suitable for use in a particular application. Parameters provided in datasheets and / or specifications may vary in different applications and performance may vary over time. All operating parameters, including typical parameters, must be validated for each customer application by the customer's technical experts. Product specifications do not expand or otherwise modify Vishay's terms and conditions of purchase, including but not limited to the warranty expressed therein.

Hyperlinks included in this datasheet may direct users to third-party websites. These links are provided as a convenience and for informational purposes only. Inclusion of these hyperlinks does not constitute an endorsement or an approval by Vishay of any of the products, services or opinions of the corporation, organization or individual associated with the third-party website. Vishay disclaims any and all liability and bears no responsibility for the accuracy, legality or content of the third-party website or for that of subsequent links.

Except as expressly indicated in writing, Vishay products are not designed for use in medical, life-saving, or life-sustaining applications or for any other application in which the failure of the Vishay product could result in personal injury or death. Customers using or selling Vishay products not expressly indicated for use in such applications do so at their own risk. Please contact authorized Vishay personnel to obtain written terms and conditions regarding products designed for such applications.

No license, express or implied, by estoppel or otherwise, to any intellectual property rights is granted by this document or by any conduct of Vishay. Product names and markings noted herein may be trademarks of their respective owners.