

40.0 x 5.0 x 6.0 (mm) LTE FullBand PCB Substrate Antenna (EVB+CC40D9)Engineering Specification

1. Product Number

H 2 B 1 M H 3 A 2 F 0 1 0 0



2. Features

- * Compatible with LTE full-band/ 3G/ 2G
- * Stable and reliable in performances
- * Compact size
- * RoHS2.0 compliance
- * SMT processes compatible

3. Applications

- * LTE full-band/ 3G/ 2G.
- * LTE / GSM / CDMA /DCS /PCS / WCDMA / UMTS / HSDPA / GPRS / EDGE /IMT.



詠業科技股份有限公司
Unictron Technologies Corporation
Website:www.unictron.com

THIS DRAWINGS AND SPECIFICATIONS ARE THE PROPERTY OF UNICTRON TECHNOLOGIES CORPORATION AND SHALL NOT BE REPRODUCED OR USED AS THE BASIS FOR THE MANUFACTURE OR SALE OF APPARATUS OR DEVICES WITHOUT PERMISSION

Prepared by : Wen Designed by : Allen Checked by : Mike Approved by : Herbert

TITLE : 40.0 x 5.0 x 6.0 (mm) LTE FullBand PCB Substrate Antenna (EVB+CC40D9)Engineering Specification	DOCUMENT NO.	H2B1MH3A2F0100	REV.
			B

4. Description

Unictron's CC40D9 ceramic chip antenna is designed for cellular 2G/ 3G/ LTE bands applications, covering frequencies 698~960 MHz & 1710~2690 MHz. Fabricated with proprietary design and processes, CC40D9 shows excellent performance and is fully compatible with SMT processes which can decrease the assembly cost and improve device's quality and consistency.

5. Layout Guide & Electrical Specifications

5-1. Layout Guide (Unit: mm)

Solder Land Pattern:

The solder land pattern (gold marking areas) is shown below. Recommendation on matching circuit will be provided according to customer's installation conditions.

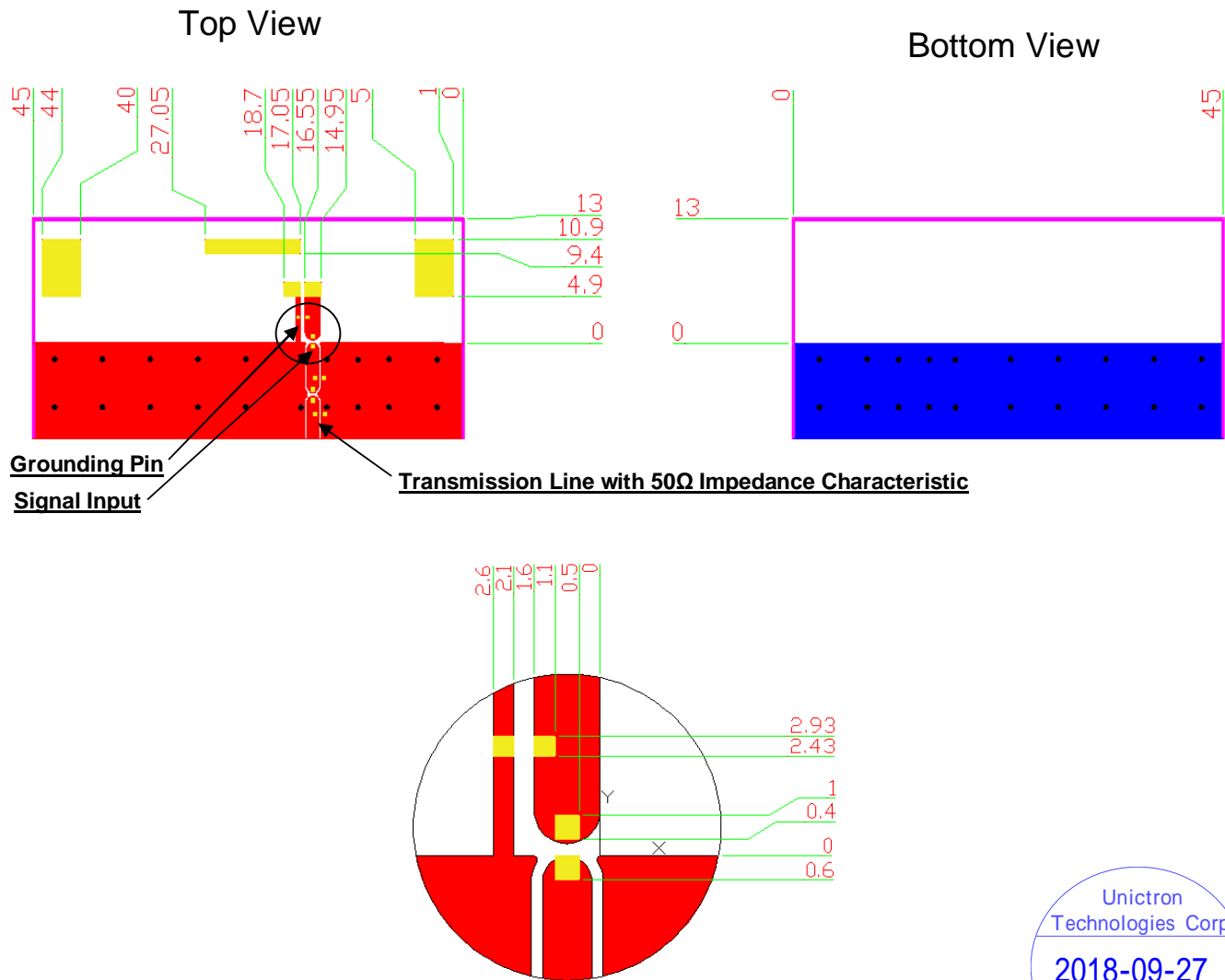

詠業科技股份有限公司
Unictron Technologies Corporation
Website: www.unictron.com

THIS DRAWINGS AND SPECIFICATIONS ARE THE PROPERTY OF UNICTRON TECHNOLOGIES CORPORATION AND SHALL NOT BE REPRODUCED OR USED AS THE BASIS FOR THE MANUFACTURE OR SALE OF APPARATUS OR DEVICES WITHOUT PERMISSION



Prepared by : **Wen** Designed by : **Allen** Checked by : **Mike** Approved by : **Herbert**

TITLE : 40.0 x 5.0 x 6.0 (mm) LTE FullBand PCB Substrate Antenna (EVb+CC40D9)Engineering Specification	DOCUMENT NO.	H2B1MH3A2F0100	REV.
			B

5-2. Electrical Specifications (with 120 x 45 mm² Evaluation Board)

5-2-1. Electrical Table

Characteristics	Specifications				
Outline Dimension (mm)	40.0 x 5.0 x 6.0				
Ground Plane Dimension (mm)	107 x 45				
Working Frequency (MHz)	698 ~ 798	824 ~ 960	1710 ~ 2170	2300 ~ 2400	2490 ~ 2690
Peak Gain (dBi) (typical)**	1.4	0.7	3.2	3.8	4.2
Efficiency (%) (typical)**	65	57	69	67	62
VSWR (@ center frequency)*	< 3.5 : 1				
Characteristic Impedance (Ω)	50				
Polarization	Linear Polarization				

*Center frequency means the frequency with the lowest value in return loss of the chip antenna on the evaluation board.

**A typical value is for reference only, not guaranteed.

5-2-2. V.S.W.R. and Total Radiation Gain vs. Frequency

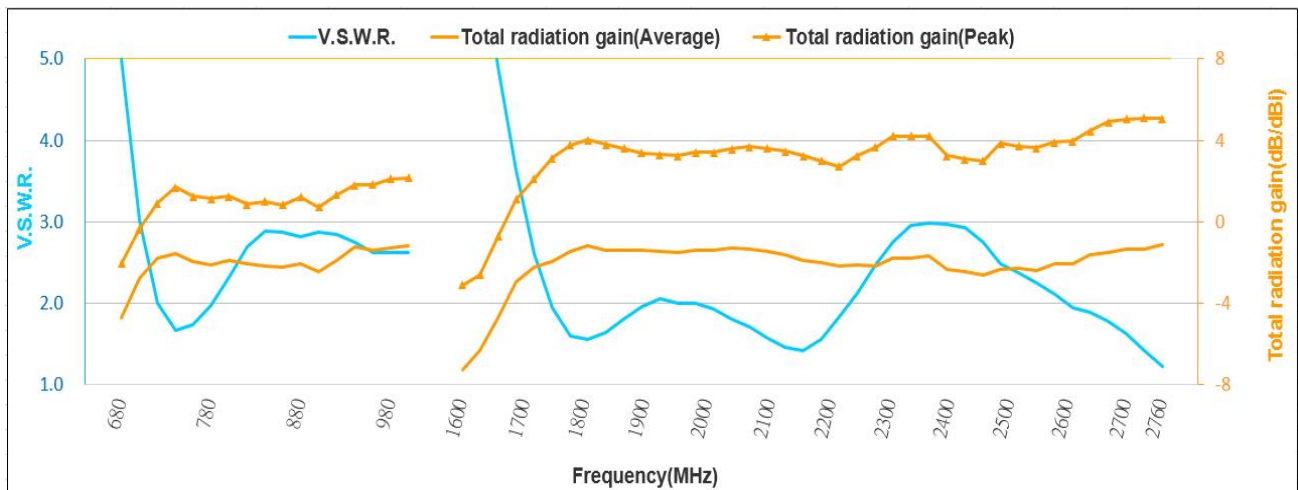

詠業科技股份有限公司
Unictron Technologies Corporation
Website: www.unictron.com

THIS DRAWINGS AND SPECIFICATIONS ARE THE PROPERTY OF UNICTRON TECHNOLOGIES CORPORATION AND SHALL NOT BE REPRODUCED OR USED AS THE BASIS FOR THE MANUFACTURE OR SALE OF APPARATUS OR DEVICES WITHOUT PERMISSION

Prepared by : Wen

Designed by : Allen

Checked by : Mike

Approved by : Herbert

TITLE : 40.0 x 5.0 x 6.0 (mm) LTE FullBand PCB Substrate Antenna (EVB+CC40D9)Engineering Specification

DOCUMENT NO.

H2B1MH3A2F0100

REV. B

6. Outline Dimensions of Antenna & Evaluation Board (Unit: mm)

6-1. Antenna Dimensions

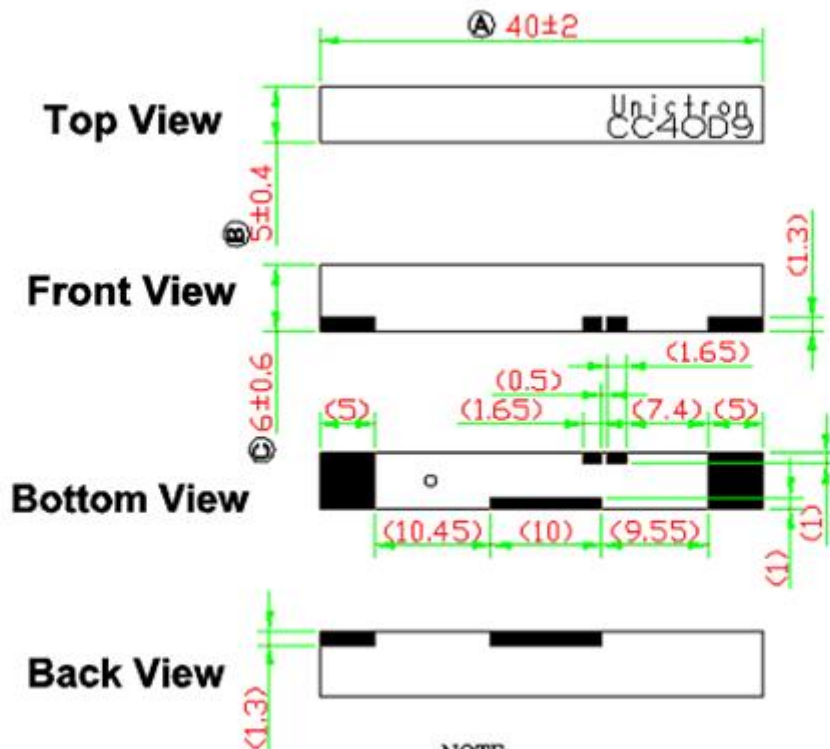
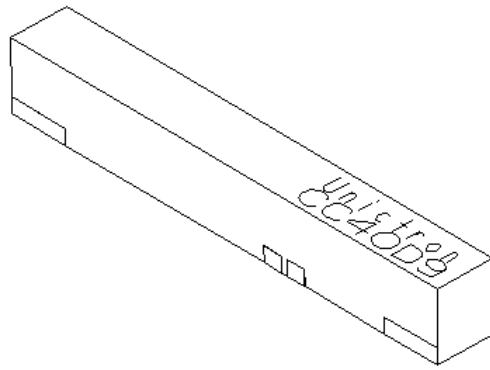

NOTE:

1. All materials are RoHS 2.0 compliant.
2. "A"~"C" Critical Dimensions.
3. "()" Reference Dimensions.



詠業科技股份有限公司
Unictron Technologies Corporation
Website: www.unictron.com

THIS DRAWINGS AND SPECIFICATIONS ARE THE PROPERTY OF UNICTRON TECHNOLOGIES CORPORATION AND SHALL NOT BE REPRODUCED OR USED AS THE BASIS FOR THE MANUFACTURE OR SALE OF APPARATUS OR DEVICES WITHOUT PERMISSION

Prepared by : Wen

Designed by : Allen

Checked by : Mike

Approved by : Herbert

TITLE : 40.0 x 5.0 x 6.0 (mm) LTE FullBand PCB
Substrate Antenna (EVb+CC40D9)Engineering
Specification

**DOCUMENT
NO.**

H2B1MH3A2F0100

**REV.
B**

PIN Definitions

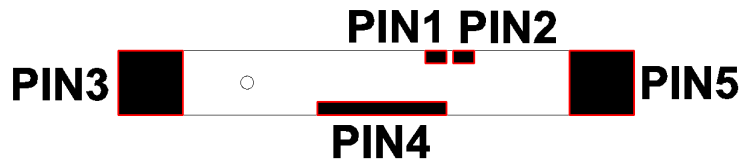

Bottom View

PIN	1	2	3~5
Soldering Pad	Tuning/Ground	Signal	N/C

6-2. Evaluation Board & Antenna's Location

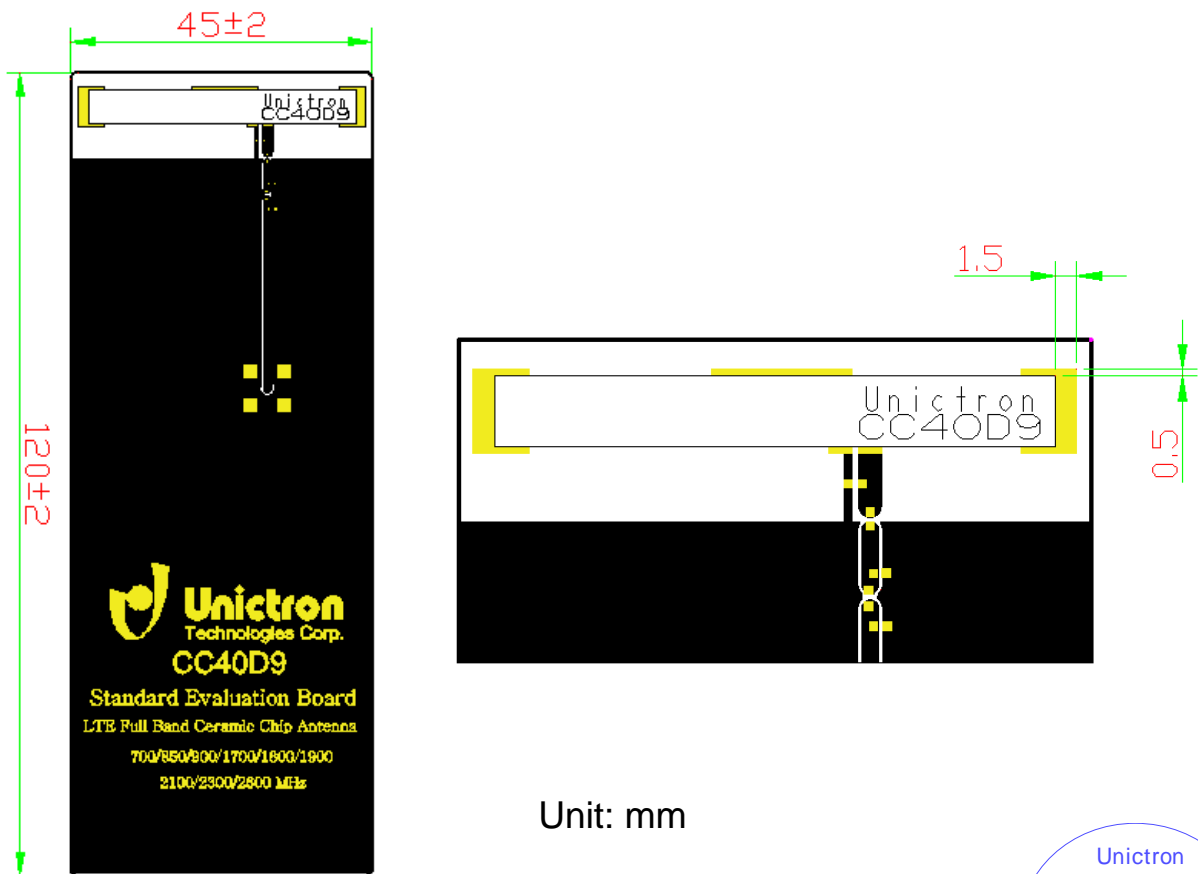

Unit: mm



詠業科技股份有限公司
Unictron Technologies Corporation
Website: www.unictron.com

THIS DRAWINGS AND SPECIFICATIONS ARE THE PROPERTY OF UNICTRON TECHNOLOGIES CORPORATION AND SHALL NOT BE REPRODUCED OR USED AS THE BASIS FOR THE MANUFACTURE OR SALE OF APPARATUS OR DEVICES WITHOUT PERMISSION

Prepared by : **Wen** Designed by : **Allen** Checked by : **Mike** Approved by : **Herbert**

TITLE : 40.0 x 5.0 x 6.0 (mm) LTE FullBand PCB Substrate Antenna (EVB+CC40D9)Engineering Specification	DOCUMENT NO.	H2B1MH3A2F0100	REV.
			B

7. 3D Radiation Gain Pattern (with 120 x 45 mm² Evaluation Board)

7-1. 698~798MHz Band

3D Radiation Gain Pattern @ 748 MHz (Unit: dBi)

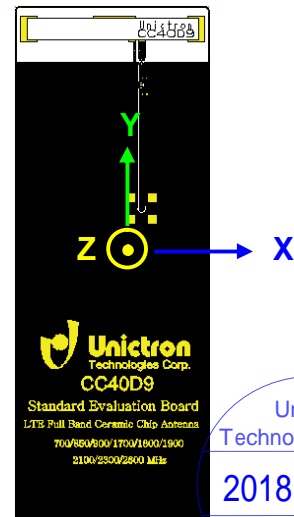
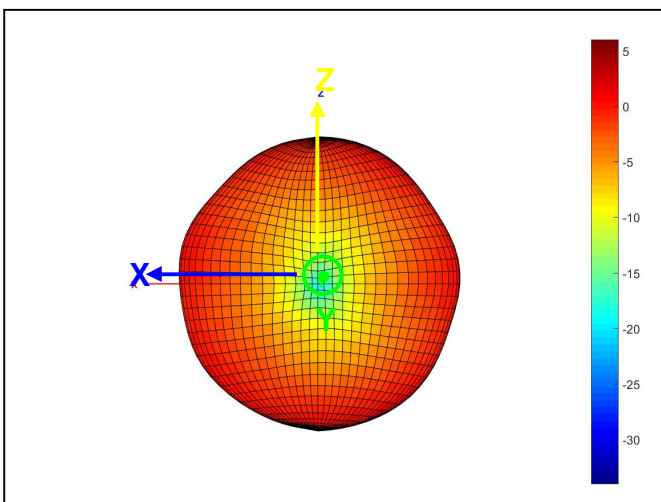
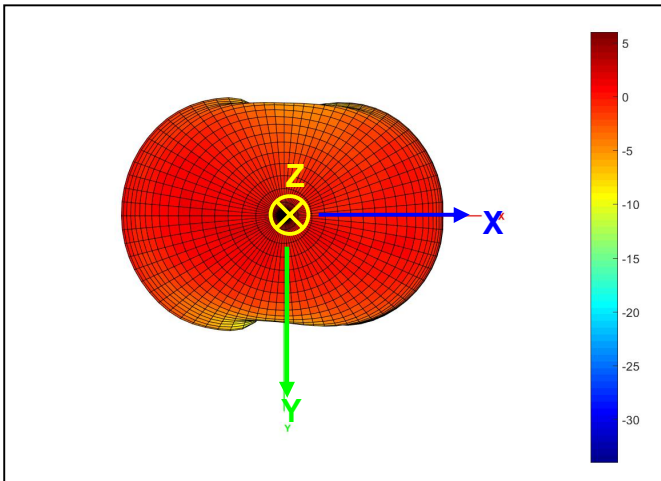
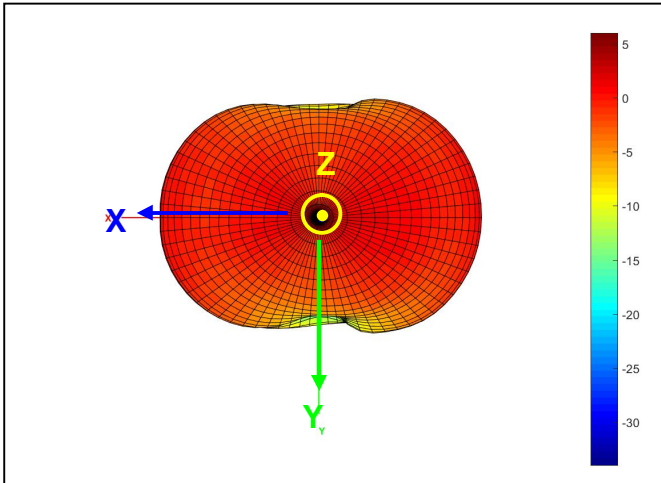

Unicon Technologies Corp.
2018-09-27

Document Control Centre



詠業科技股份有限公司
Unicon Technologies Corporation
Website: www.unicon.com

THIS DRAWINGS AND SPECIFICATIONS ARE THE PROPERTY OF UNICTRON TECHNOLOGIES CORPORATION AND SHALL NOT BE REPRODUCED OR USED AS THE BASIS FOR THE MANUFACTURE OR SALE OF APPARATUS OR DEVICES WITHOUT PERMISSION

Prepared by : Wen

Designed by : Allen

Checked by : Mike

Approved by : Herbert

TITLE : 40.0 x 5.0 x 6.0 (mm) LTE FullBand PCB Substrate Antenna (EVB+CC40D9)Engineering Specification

DOCUMENT NO.

H2B1MH3A2F0100

REV. B

7-2. 824~960MHz Band

3D Radiation Gain Pattern @ 900 MHz (Unit: dBi)

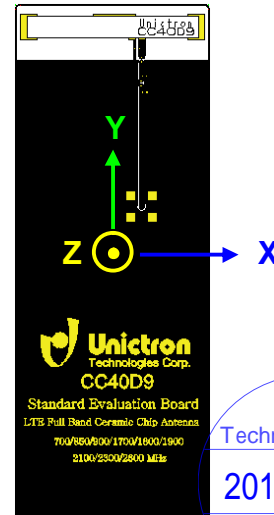
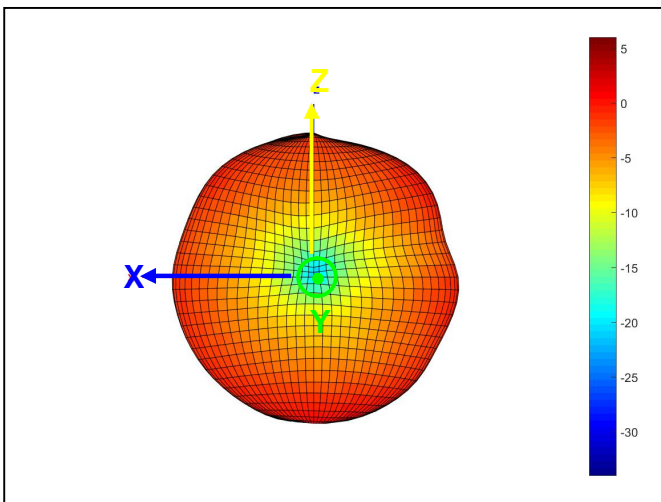
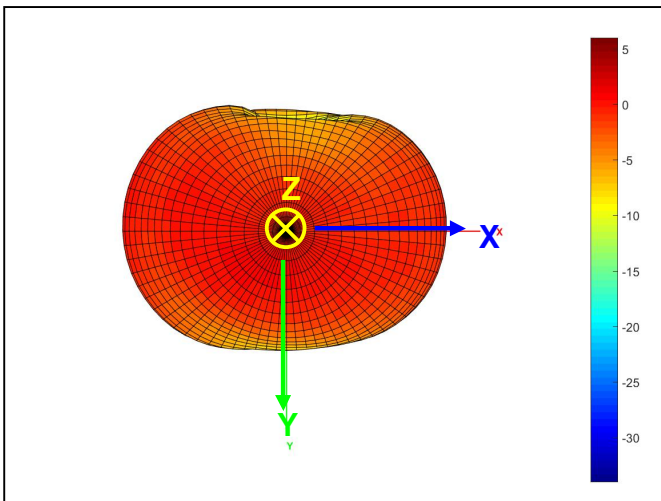
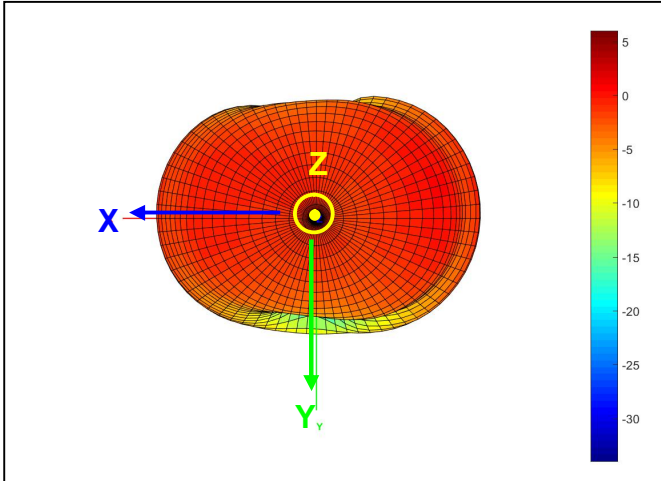

Unicontr
Technologies Corp.
2018-09-27
Document
Control Centre



詠業科技股份有限公司
Unicontr Technologies Corporation
Website: www.unicontr.com

THIS DRAWINGS AND SPECIFICATIONS ARE THE PROPERTY OF UNICTRON TECHNOLOGIES CORPORATION AND SHALL NOT BE REPRODUCED OR USED AS THE BASIS FOR THE MANUFACTURE OR SALE OF APPARATUS OR DEVICES WITHOUT PERMISSION

Prepared by : Wen

Designed by : Allen

Checked by : Mike

Approved by : Herbert

TITLE : 40.0 x 5.0 x 6.0 (mm) LTE FullBand PCB
Substrate Antenna (EVB+CC40D9)Engineering
Specification

DOCUMENT
NO.

H2B1MH3A2F0100

REV.
B

7-3. 1710~2170MHz Band

3D Radiation Gain Pattern @ 1950 MHz (Unit: dBi)

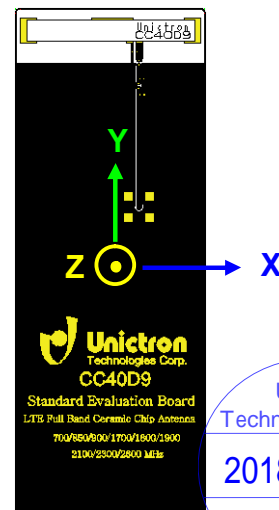
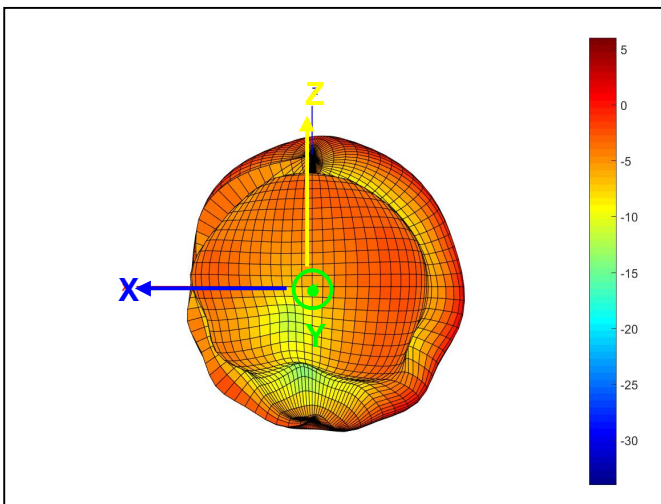
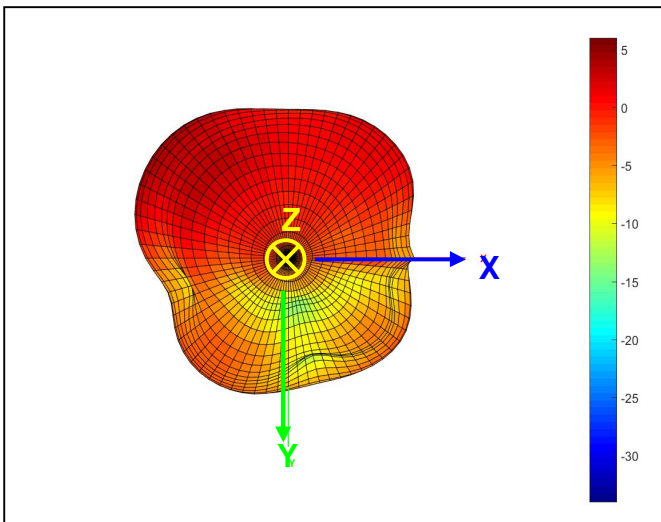
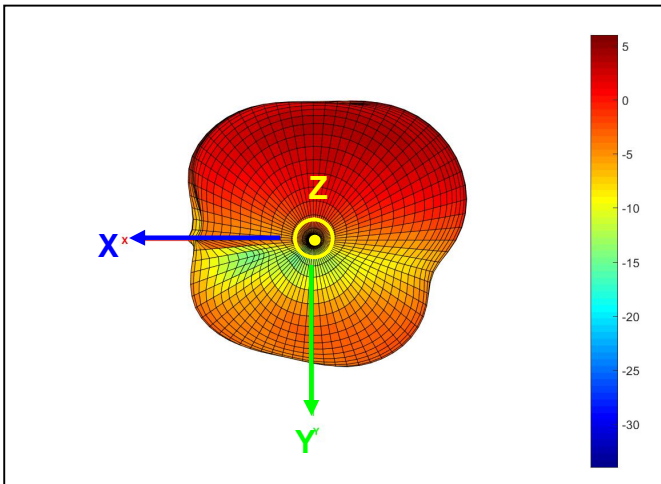

Unictron Technologies Corp.
2018-09-27
Document Control Centre



詠業科技股份有限公司
Unictron Technologies Corporation
Website: www.unictron.com

THIS DRAWINGS AND SPECIFICATIONS ARE THE PROPERTY OF UNICTRON TECHNOLOGIES CORPORATION AND SHALL NOT BE REPRODUCED OR USED AS THE BASIS FOR THE MANUFACTURE OR SALE OF APPARATUS OR DEVICES WITHOUT PERMISSION

Prepared by : Wen

Designed by : Allen

Checked by : Mike

Approved by : Herbert

TITLE : 40.0 x 5.0 x 6.0 (mm) LTE FullBand PCB Substrate Antenna (EVB+CC40D9)Engineering Specification

DOCUMENT NO.

H2B1MH3A2F0100

REV. B

7-4. 2300~2400MHz Band

3D Radiation Gain Pattern @ 2350 MHz (Unit: dBi)

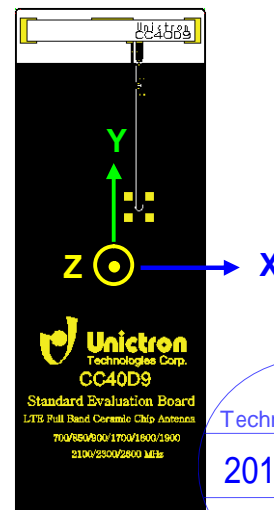
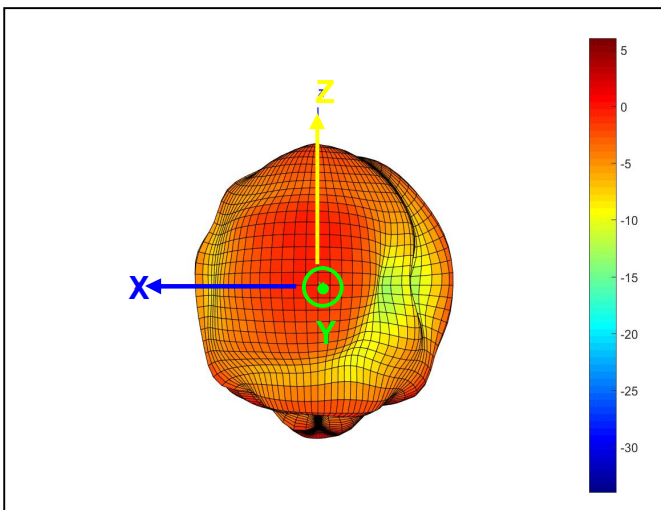
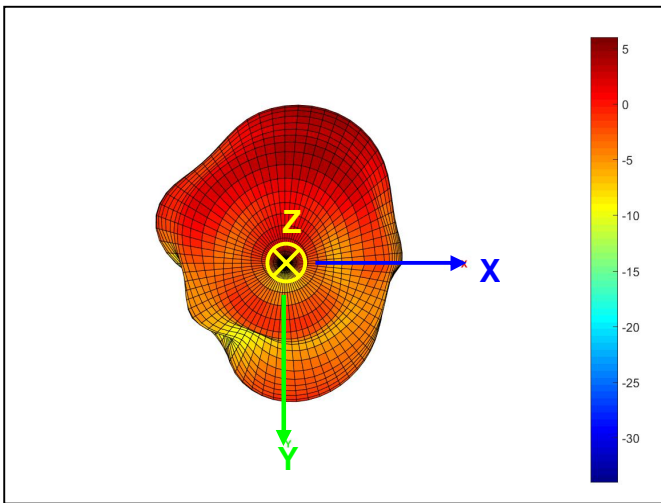
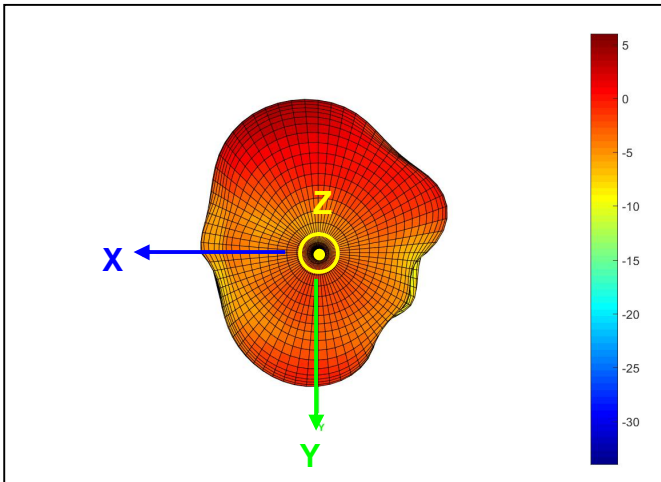

Unictron Technologies Corp.
2018-09-27
Document Control Centre



詠業科技股份有限公司
Unictron Technologies Corporation
Website: www.unictron.com

THIS DRAWINGS AND SPECIFICATIONS ARE THE PROPERTY OF UNICTRON TECHNOLOGIES CORPORATION AND SHALL NOT BE REPRODUCED OR USED AS THE BASIS FOR THE MANUFACTURE OR SALE OF APPARATUS OR DEVICES WITHOUT PERMISSION

Prepared by : Wen

Designed by : Allen

Checked by : Mike

Approved by : Herbert

TITLE : 40.0 x 5.0 x 6.0 (mm) LTE FullBand PCB Substrate Antenna (EVB+CC40D9)Engineering Specification

DOCUMENT NO.

H2B1MH3A2F0100

REV. B

7-5. 2490~2690MHz Band

3D Radiation Gain Pattern @ 2590 MHz (Unit: dBi)

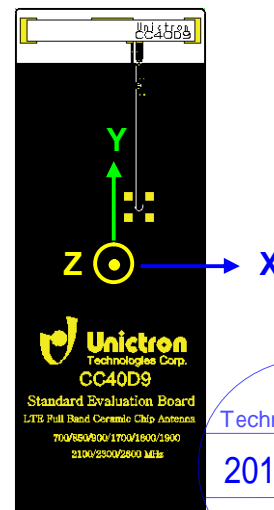
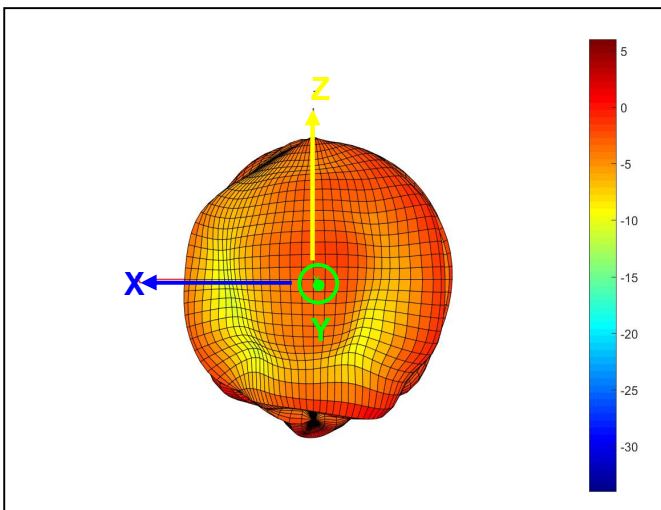
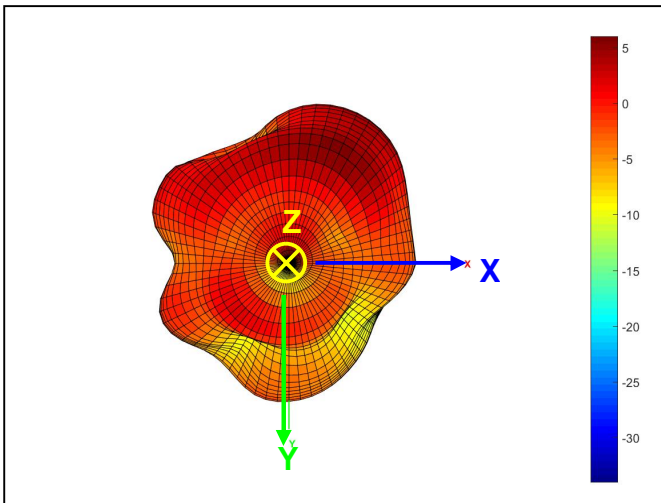
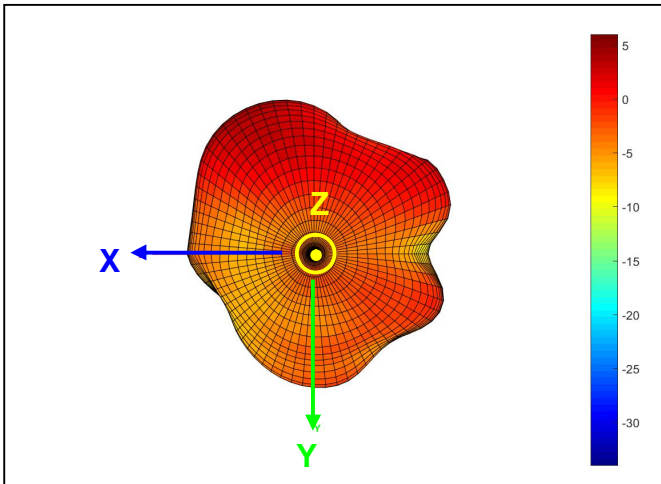

Unictron
Technologies Corp.
2018-09-27
Document
Control Centre



詠業科技股份有限公司
Unictron Technologies Corporation
Website: www.unictron.com

THIS DRAWINGS AND SPECIFICATIONS ARE THE PROPERTY OF UNICTRON TECHNOLOGIES CORPORATION AND SHALL NOT BE REPRODUCED OR USED AS THE BASIS FOR THE MANUFACTURE OR SALE OF APPARATUS OR DEVICES WITHOUT PERMISSION

Prepared by : Wen

Designed by : Allen

Checked by : Mike

Approved by : Herbert

TITLE : 40.0 x 5.0 x 6.0 (mm) LTE FullBand PCB Substrate Antenna (EVB+CC40D9)Engineering Specification

DOCUMENT NO.

H2B1MH3A2F0100

REV. B

8. Frequency tuning

8-1. Chip antenna tuning scenario :

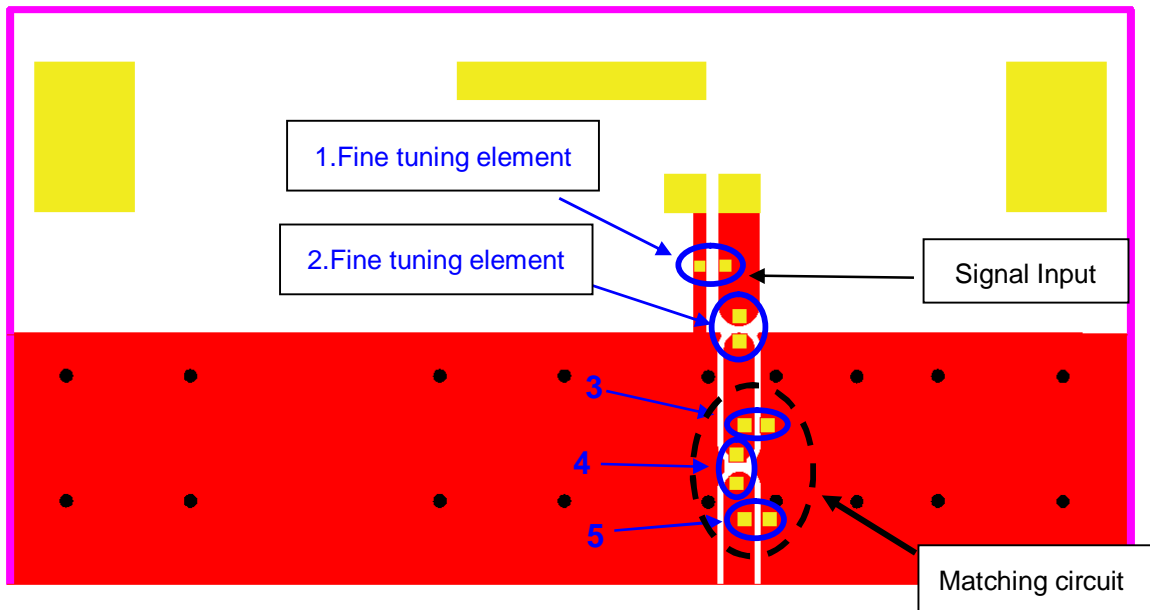

8-2. Matching circuit :

With the following recommended values of matching and tuning components, the covering frequencies will be about 698~960 MHz & 1710~2690 MHz at our standard 120 x 45 mm² evaluation board. However, these are typical reference values which may need to be changed when circuit boards or part vendors are different.

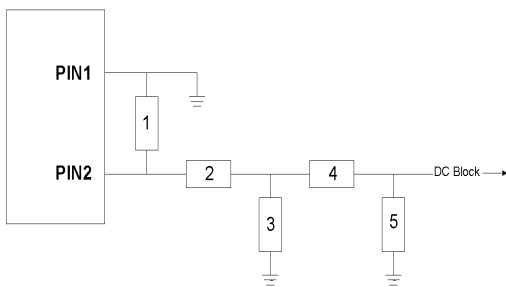

System Matching Circuit Component			
Location	Description	Vendor	Tolerance
1	Fine tuning element	MURATA	±0.1 nH
2	Fine tuning element	MURATA	±0.05 pF
3	N/C	-	-
4	0Ω (0402)	-	-
5	N/C	-	-



詠業科技股份有限公司
Unictron Technologies Corporation
Website: www.unictron.com

THIS DRAWINGS AND SPECIFICATIONS ARE THE PROPERTY OF UNICTRON TECHNOLOGIES CORPORATION AND SHALL NOT BE REPRODUCED OR USED AS THE BASIS FOR THE MANUFACTURE OR SALE OF APPARATUS OR DEVICES WITHOUT PERMISSION

Prepared by : Wen

Designed by : Allen

Checked by : Mike

Approved by : Herbert

TITLE : 40.0 x 5.0 x 6.0 (mm) LTE FullBand PCB Substrate Antenna (EVB+CC40D9)Engineering Specification

DOCUMENT NO.

H2B1MH3A2F0100

REV. B

9. Soldering Conditions

Typical Soldering Profile for Lead-free Process

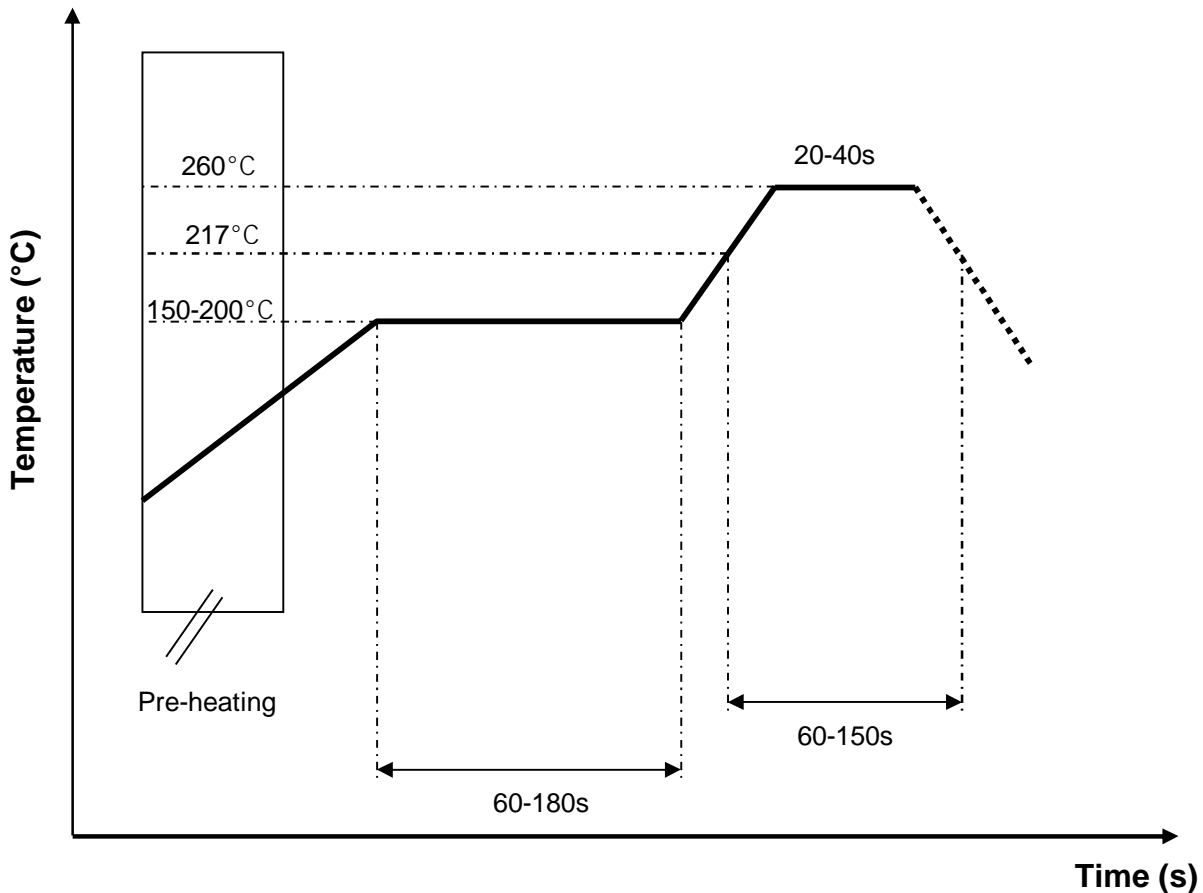

*Recommended solder paste alloy: SAC305 (Sn96.5 /Ag3 /Cu0.5) Lead Free solder paste

10. Reminders for users of Unictron's CC40D9 ceramic chip antennas

- 10-1. This chip antenna is made of ceramic materials which is relatively more rigid and brittle compared to circuit board materials. Furthermore, the length of this antenna is quite long. Bending of circuit board at the locations where chip antenna is mounted may cause the cracking of solder joints or antenna itself.
- 10-2. Punching/cutting of the break-off tab of PCB panel may cause severe bending of the circuit board which may result in cracking of solder joints or chip antenna itself. Therefore break-off tab shall be located away from the installation site of chip antenna.
- 10-3. Be cautious when ultrasonic welding process needs to be used near the locations where chip antennas are installed. Strong ultrasonic vibration may cause the cracking of chip antenna solder joints.



詠業科技股份有限公司
Unictron Technologies Corporation
Website: www.unictron.com

THIS DRAWINGS AND SPECIFICATIONS ARE THE PROPERTY OF UNICTRON TECHNOLOGIES CORPORATION AND SHALL NOT BE REPRODUCED OR USED AS THE BASIS FOR THE MANUFACTURE OR SALE OF APPARATUS OR DEVICES WITHOUT PERMISSION

Prepared by : Wen

Designed by : Allen

Checked by : Mike

Approved by : Herbert

TITLE : 40.0 x 5.0 x 6.0 (mm) LTE FullBand PCB Substrate Antenna (EVB+CC40D9)Engineering Specification

DOCUMENT NO.

H2B1MH3A2F0100

REV. B

11. Operating & Storage Conditions

11-1. Operating

- (1) Maximum Input Power: 2 W
- (2) Operating Temperature: -40°C to 85°C
- (3) Relative Humidity: 10% to 70%

11-2. Storage (sealed)

- (1) Storage Temperature: -5°C to 40°C
- (2) Relative Humidity: 20% to 70%
- (3) Shelf Life: 1 year

12. Notice

(1) Installation Guide:

Please refer to Unictron's application note "General guidelines for the installation of Unictron's chip antennas" for further information.

(2) All specifications are subject to change without notice.



詠業科技股份有限公司
Unictron Technologies Corporation
Website: www.unictron.com

THIS DRAWINGS AND SPECIFICATIONS ARE THE PROPERTY OF UNICTRON TECHNOLOGIES CORPORATION AND SHALL NOT BE REPRODUCED OR USED AS THE BASIS FOR THE MANUFACTURE OR SALE OF APPARATUS OR DEVICES WITHOUT PERMISSION

Prepared by : **Wen**

Designed by : **Allen**

Checked by : **Mike**

Approved by : **Herbert**

TITLE : 40.0 x 5.0 x 6.0 (mm) LTE FullBand PCB Substrate Antenna (EVb+CC40D9)Engineering Specification

DOCUMENT NO.

H2B1MH3A2F0100

REV. B

13. Reliability Test

Test Items	Test Conditions	Result
1. Solderability	*Solder Temperature : 250 ± 5°C *Test time: 2 +/- 0.5 sec *With solder paste	Pass
2. Temperature cycling	-40°C/ 30min~90°C /30min Total <u>10</u> cycles * Specimens are kept at standard measurement environment for more than 24 hours before testing.	Pass
3. Damp heat	*Humidity:90~95% *Temperature: 85°C *Test time : 240 hours * Specimens are kept at standard measurement environment for more than 24 hours before testing..	Pass
4. Adhesive strength of terminal electrodes	* Resistance to bending of printed-circuit test board(110x40x1.6mm) * Applied force: 5Kgf ; * Duration : 10±1sec	Pass
5. High temperature exposure	*Temperature : 90°C *Test duration : 240 hours * Specimens are kept at standard measurement environment for more than 24 hours before testing.	Pass
6. Low temperature exposure	*Temperature : -40°C *Test duration : 240 hours * Specimens are kept at standard measurement environment for more than 24 hours before testing.	Pass



詠業科技股份有限公司
 Unictron Technologies Corporation
 Website:www.unictron.com

THIS DRAWINGS AND SPECIFICATIONS ARE THE PROPERTY OF UNICTRON TECHNOLOGIES CORPORATION AND SHALL NOT BE REPRODUCED OR USED AS THE BASIS FOR THE MANUFACTURE OR SALE OF APPARATUS OR DEVICES WITHOUT PERMISSION



Prepared by : **Wen** Designed by : **Allen** Checked by : **Mike** Approved by : **Herbert**

TITLE : 40.0 x 5.0 x 6.0 (mm) LTE FullBand PCB Substrate Antenna (EVB+CC40D9)Engineering Specification	DOCUMENT NO.	H2B1MH3A2F0100	REV.
			B