

NSP8814, NSP8818

ESD and Surge Protection Device

Low Capacitance Surge Protection for High Speed Data

The NSP8814 and NSP8818 surge protectors are designed specifically to protect 10/100 and GbE Ethernet signals from high levels of surge current. Low clamping voltage under high surge conditions make this device an ideal solution for protecting voltage sensitive lines leading to Ethernet transceiver chips. Low capacitance combined with flow-through style packaging allows for easy PCB layout and matched trace lengths necessary to maintain consistent impedance between high-speed differential lines.

Features

- Protection for the Following IEC Standards:
 - IEC 61000-4-2 (ESD) ± 30 kV (Contact)
 - IEC 61000-4-5 (Lightning) 35 A (8/20 μ s)
- Flow-Thru Routing Scheme
- Low Capacitance: 2 pF Max (I/O to I/O)
- UL Flammability Rating of 94 V-0
- These Devices are Pb-Free, Halogen Free/BFR Free and are RoHS Compliant

Typical Applications

- 10/100 and GbE Ethernet
- MagJacks® / Integrated Magnetics
- Notebooks/Desktops/Servers

MAXIMUM RATINGS ($T_J = 25^\circ\text{C}$ unless otherwise noted)

Rating	Symbol	Value	Unit
Operating Junction Temperature Range	T_J	-55 to +125	$^\circ\text{C}$
Storage Temperature Range	T_{stg}	-55 to +150	$^\circ\text{C}$
Lead Solder Temperature – Maximum (10 Seconds)	T_L	260	$^\circ\text{C}$
IEC 61000-4-2 Contact (ESD) IEC 61000-4-2 Air (ESD)	ESD	± 30 ± 30	kV
Maximum Peak Pulse Current 8/20 μ s @ $T_A = 25^\circ\text{C}$ 10/700 μ s @ $T_A = 25^\circ\text{C}$	I_{pp}	35 20	A

Stresses exceeding those listed in the Maximum Ratings table may damage the device. If any of these limits are exceeded, device functionality should not be assumed, damage may occur and reliability may be affected.

See Application Note AND8308/D for further description of survivability specs.



ON Semiconductor®

www.onsemi.com

MARKING DIAGRAMS

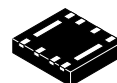

UDFN8
CASES 506CV

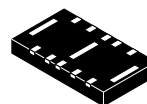

UDFN10
CASE 506CU

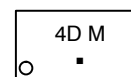

- XX = Specific Device Code
- M = Date Code
- = Pb-Free Package

ORDERING INFORMATION

Device	Package	Shipping
NSP8814MUTAG	UDFN8 (Pb-Free)	3000 / Tape & Reel
NSP8818MUTAG	UDFN10 (Pb-Free)	3000 / Tape & Reel

†For information on tape and reel specifications, including part orientation and tape sizes, please refer to our Tape and Reel Packaging Specification Brochure, BRD8011/D.

NSP8814, NSP8818

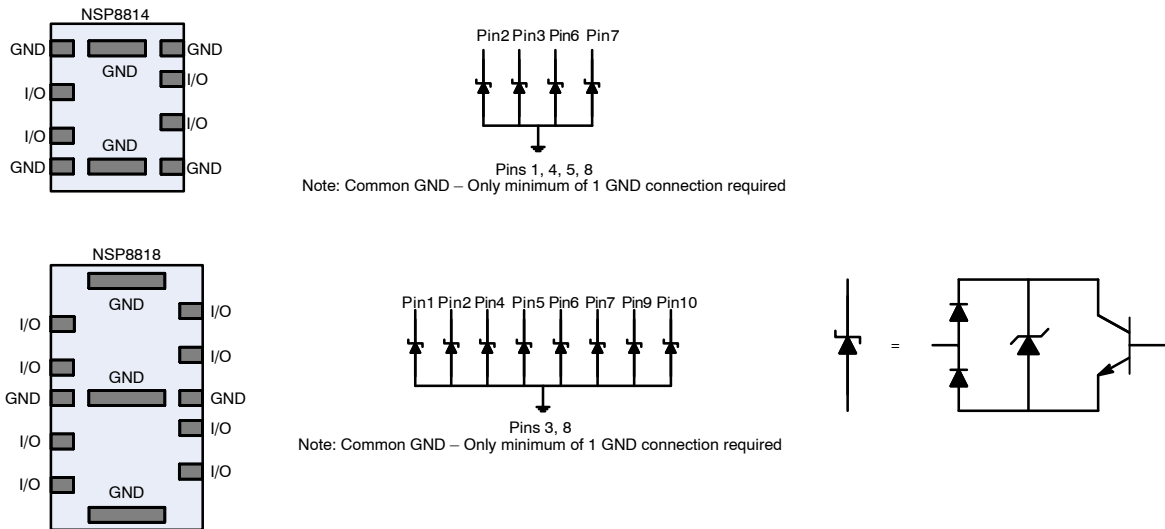
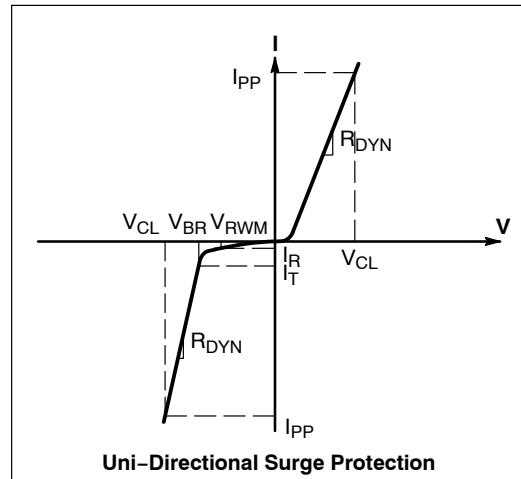

Figure 1. Pin Schematic

ELECTRICAL CHARACTERISTICS

($T_A = 25^\circ\text{C}$ unless otherwise noted)

Symbol	Parameter
V_{RWM}	Working Peak Voltage
I_R	Maximum Reverse Leakage Current @ V_{RWM}
V_{BR}	Breakdown Voltage @ I_T
I_T	Test Current
V_{HOLD}	Holding Reverse Voltage
I_{HOLD}	Holding Reverse Current
R_{DYN}	Dynamic Resistance
I_{PP}	Maximum Peak Pulse Current
V_C	Clamping Voltage @ I_{PP} $V_C = V_{HOLD} + (I_{PP} * R_{DYN})$



ELECTRICAL CHARACTERISTICS ($T_A = 25^\circ\text{C}$ unless otherwise specified)

Parameter	Symbol	Conditions	Min	Typ	Max	Unit
Reverse Working Voltage	V_{RWM}	Any I/O to GND (Note 1)			3.0	V
Forward Voltage	V_F	$I_F = 10 \text{ mA}$, GND to All IO Pins	0.5	0.85	1.1	V
Breakdown Voltage	V_{BR}	$I_T = 1 \text{ mA}$, I/O to GND	3.2	3.5	5.0	V
Reverse Leakage Current	I_R	$V_{RWM} = 3.0 \text{ V}$, I/O to GND			0.5	μA
Clamping Voltage (Note 2)	V_C	$I_{PP} = 1 \text{ A}$ $I_{PP} = 10 \text{ A}$ $I_{PP} = 25 \text{ A}$ $I_{PP} = 35 \text{ A}$		4.0 6.0 8.0 10	5.0 6.5 10 15	V
Clamping Voltage	V_C	IEC61000-4-2, $\pm 8 \text{ kV}$ Contact	See Figures 7 and 14			V
Junction Capacitance	C_J	$V_R = 0 \text{ V}$, $f = 1 \text{ MHz}$ between I/O Pins		1.5	2.0	pF
		$V_R = 0 \text{ V}$, $f = 1 \text{ MHz}$ between I/O Pins and GND			5.0	

Product parametric performance is indicated in the Electrical Characteristics for the listed test conditions, unless otherwise noted. Product performance may not be indicated by the Electrical Characteristics if operated under different conditions.

- Surge protection devices are normally selected according to the working peak reverse voltage (V_{RWM}), which should be equal or greater than the DC or continuous peak operating voltage level.
- Any I/O to GND (8/20 μs pulse).

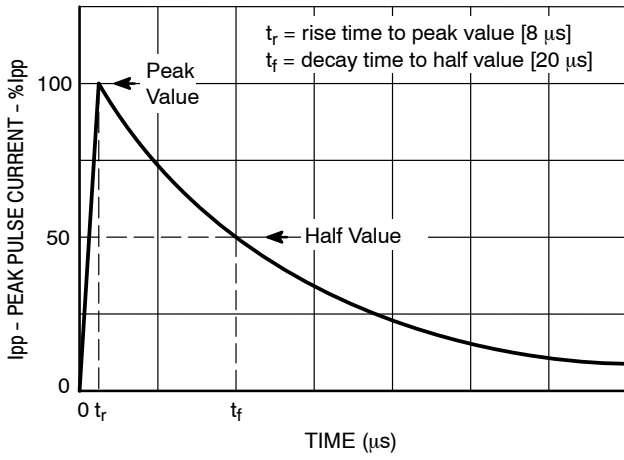

Figure 2. IEC61000-4-5 8/20 μ s Pulse Waveform

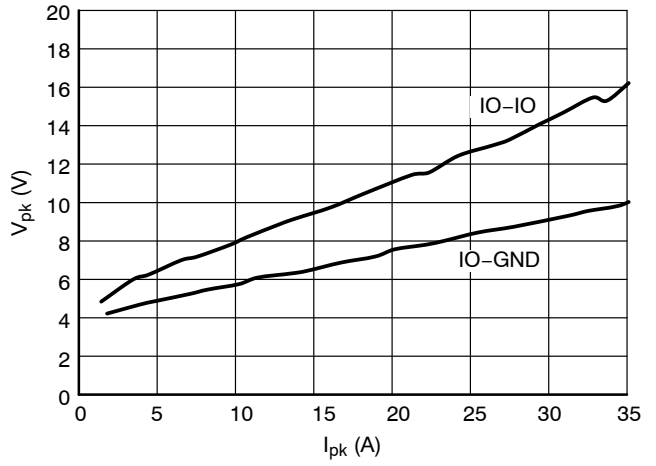

Figure 3. Clamping Voltage vs. Peak Pulse Current ($t_p = 8/20 \mu$ s per Figure 2)

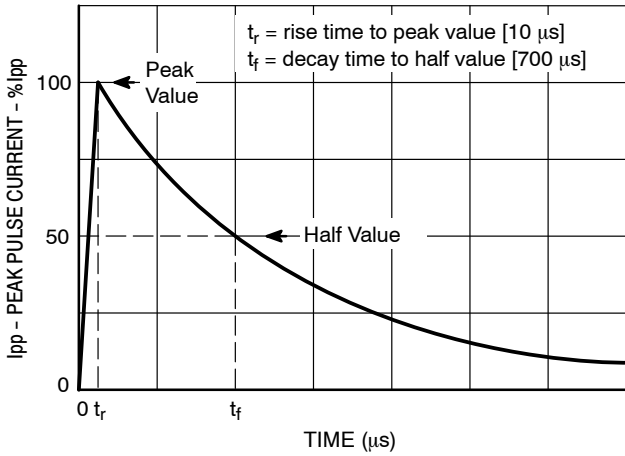

Figure 4. IEC61000-4-5 10/700 μ s Pulse Waveform

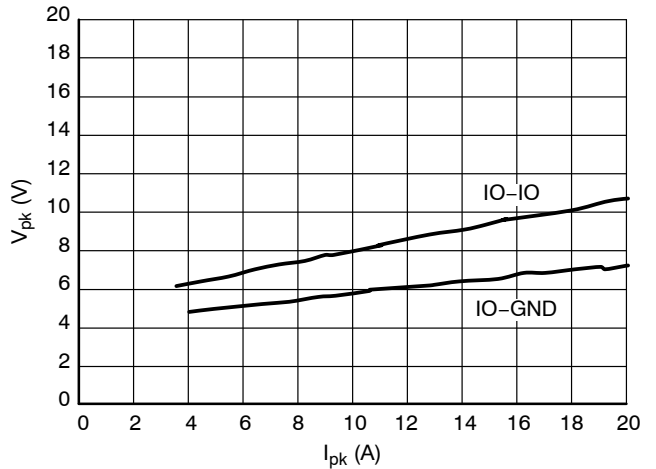

Figure 5. Clamping Voltage vs. Peak Pulse Current ($t_p = 10/700 \mu$ s per Figure 4)

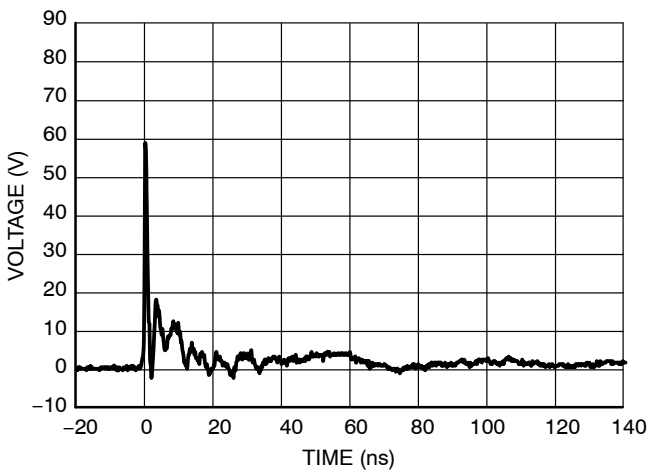

Figure 6. IEC61000-2-4 +8 kV Contact Clamping Voltage

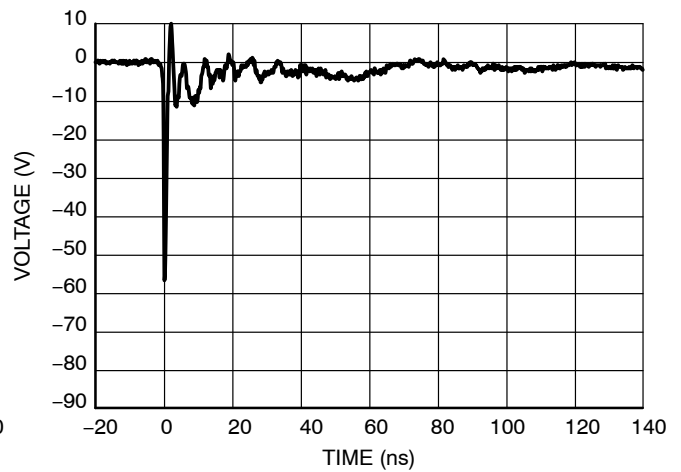

Figure 7. IEC61000-2-4 -8 kV Contact Clamping Voltage

NSP8814, NSP8818

IEC 61000-4-2 Spec.

Level	Test Voltage (kV)	First Peak Current (A)	Current at 30 ns (A)	Current at 60 ns (A)
1	2	7.5	4	2
2	4	15	8	4
3	6	22.5	12	6
4	8	30	16	8



Figure 8. IEC61000-4-2 Spec

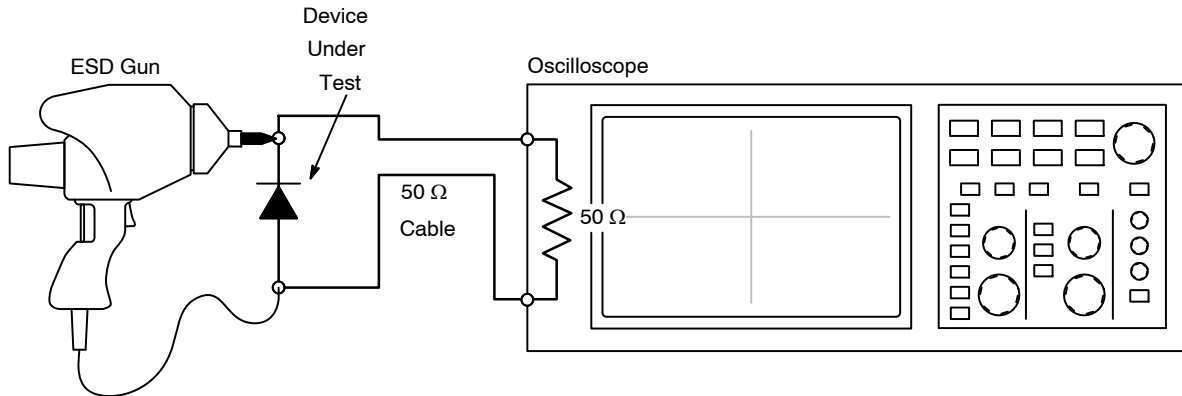

Figure 9. Diagram of ESD Clamping Voltage Test Setup

The following is taken from Application Note AND8308/D – Interpretation of Datasheet Parameters for ESD Devices.

ESD Voltage Clamping

For sensitive circuit elements it is important to limit the voltage that an IC will be exposed to during an ESD event to as low a voltage as possible. The ESD clamping voltage is the voltage drop across the ESD protection diode during an ESD event per the IEC61000-4-2 waveform. Since the IEC61000-4-2 was written as a pass/fail spec for larger

systems such as cell phones or laptop computers it is not clearly defined in the spec how to specify a clamping voltage at the device level. ON Semiconductor has developed a way to examine the entire voltage waveform across the ESD protection diode over the time domain of an ESD pulse in the form of an oscilloscope screenshot, which can be found on the datasheets for all ESD protection diodes. For more information on how ON Semiconductor creates these screenshots and how to interpret them please refer to AND8307/D.

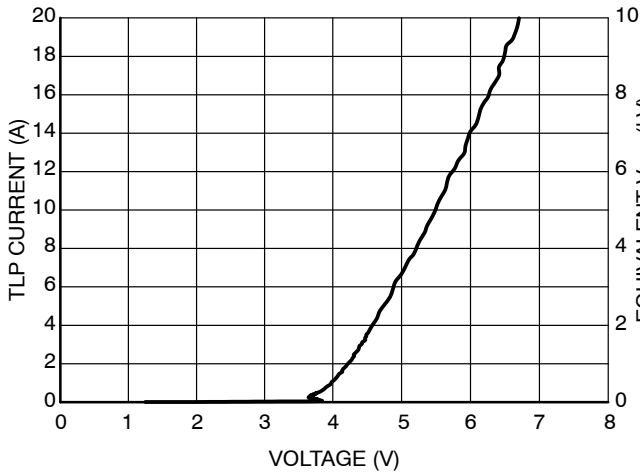

Figure 10. Positive TLP IV Curve

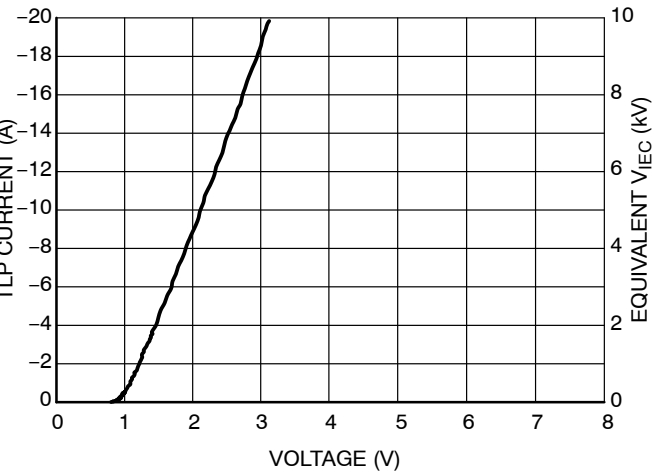

Figure 11. Negative TLP IV Curve

NOTE: TLP parameter: $Z_0 = 50 \Omega$, $t_p = 100 \text{ ns}$, $t_r = 300 \text{ ps}$, averaging window: $t_1 = 30 \text{ ns}$ to $t_2 = 60 \text{ ns}$.

Transmission Line Pulse (TLP) Measurement

Transmission Line Pulse (TLP) provides current versus voltage (I-V) curves in which each data point is obtained from a 100 ns long rectangular pulse from a charged transmission line. A simplified schematic of a typical TLP system is shown in Figure 12. TLP I-V curves of ESD protection devices accurately demonstrate the product’s ESD capability because the 10s of amps current levels and under 100 ns time scale match those of an ESD event. This is illustrated in Figure 13 where an 8 kV IEC 61000-4-2 current waveform is compared with TLP current pulses at 8 A and 16 A. A TLP I-V curve shows the voltage at which the device turns on as well as how well the device clamps voltage over a range of current levels.

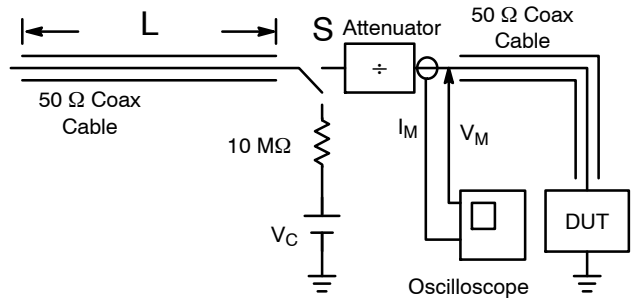

Figure 12. Simplified Schematic of a Typical TLP System

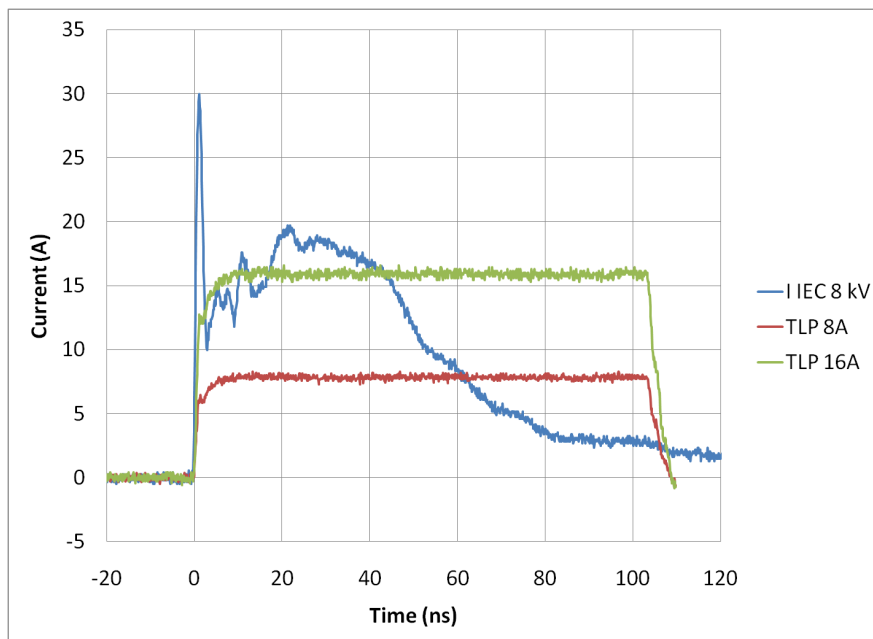

Figure 13. Comparison Between 8 kV IEC 61000-4-2 and 8 A and 16 A TLP Waveforms

NSP8814, NSP8818

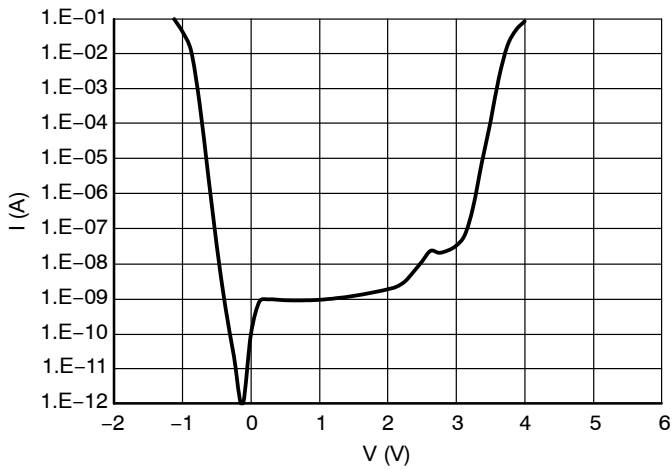

Figure 14. IV Characteristics

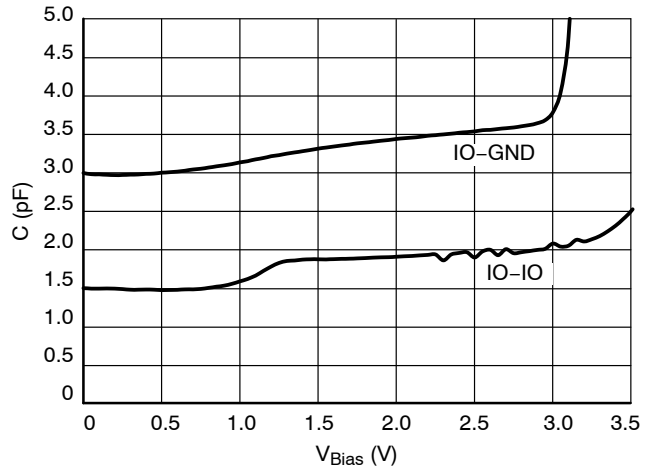

Figure 15. CV Characteristics

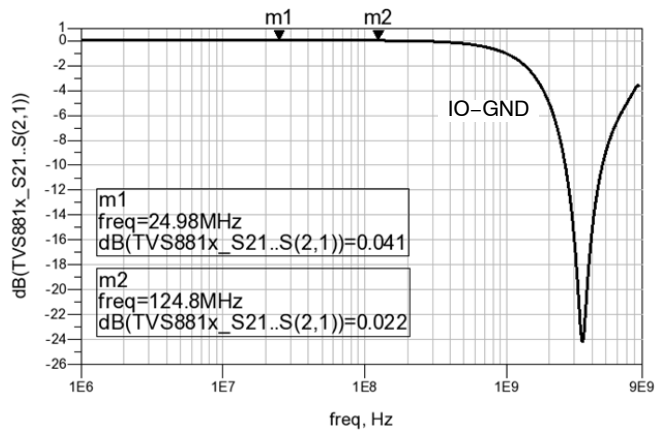

Figure 16. RF Insertion Loss

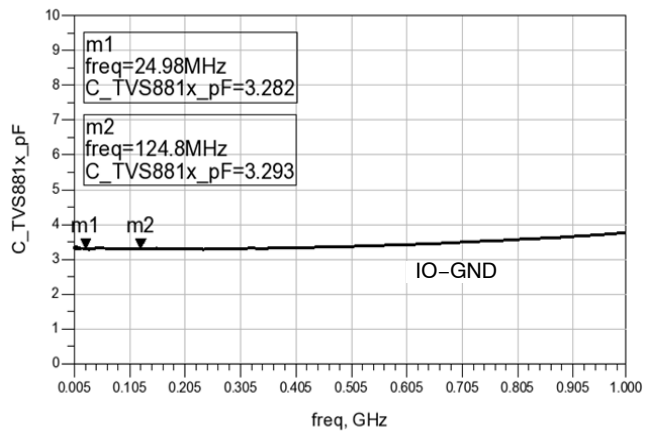

Figure 17. Capacitance Over Frequency

NSP8814, NSP8818

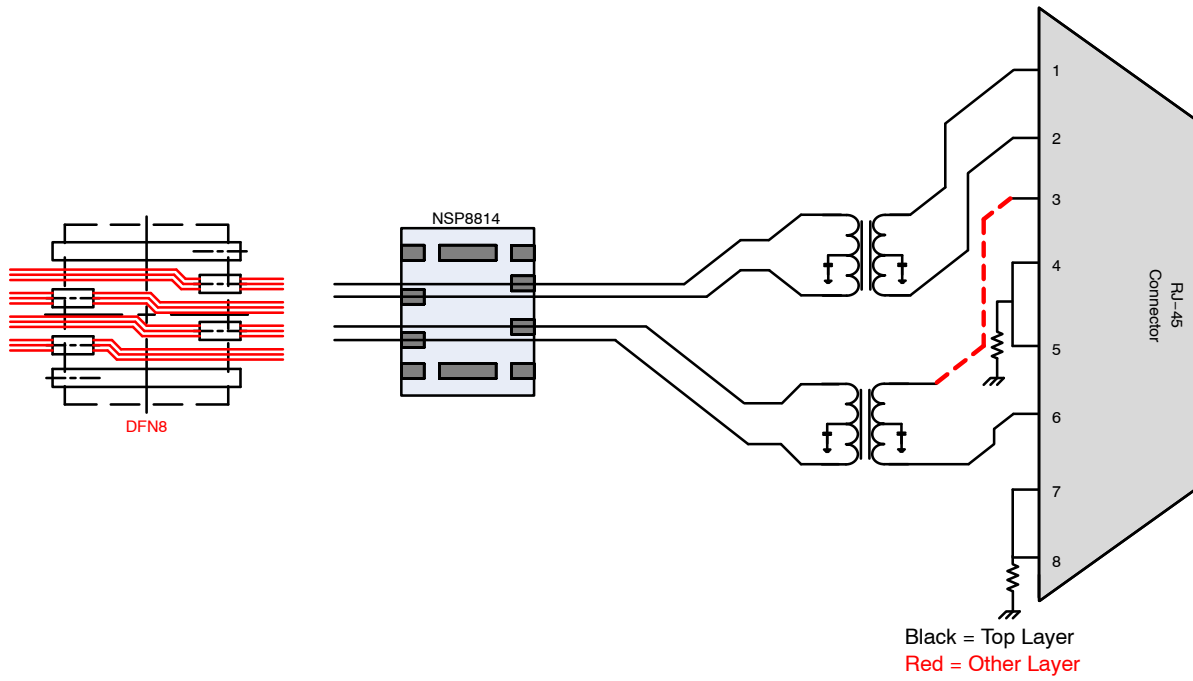

Figure 18. 10/100 Ethernet Layout Diagram and Flow-thru Routing Scheme

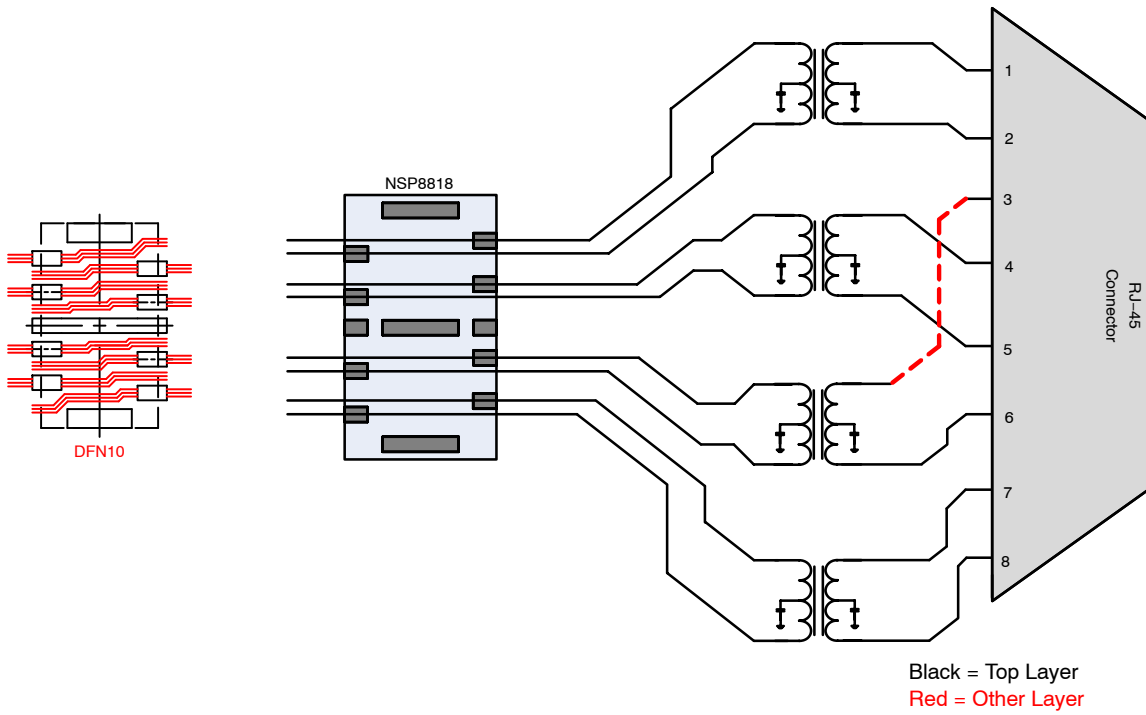
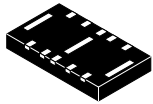

Figure 19. GbE Ethernet Layout Diagram and Flow-thru Routing Scheme

MECHANICAL CASE OUTLINE

PACKAGE DIMENSIONS

ON Semiconductor®



UDFN10 3.5x2, 0.575P
CASE 506CU
ISSUE O

DATE 05 NOV 2013

SCALE 4:1

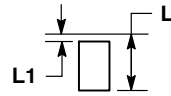
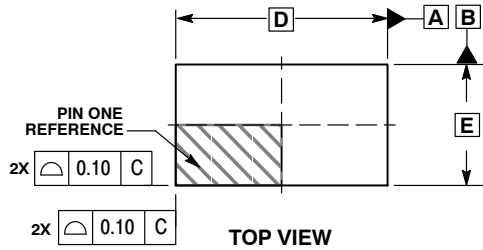

NOTES:

1. DIMENSIONING AND TOLERANCING PER ASME Y14.5M, 1994.
2. CONTROLLING DIMENSION: MILLIMETERS.
3. DIMENSIONS b APPLIES TO PLATED TERMINAL AND IS MEASURED BETWEEN 0.15 AND 0.25 MM FROM TERMINAL TIP.
4. COPLANARITY APPLIES TO THE EXPOSED PAD AS WELL AS THE TERMINALS.

DIM	MILLIMETERS	
	MIN	MAX
A	0.45	0.55
A1	0.00	0.05
A3	0.127	REF
b	0.15	0.25
D	3.50 BSC	
E	2.00 BSC	
e	0.575 BSC	
e2	0.40 BSC	
e3	3.10 BSC	
L	0.25	0.35
L1	0.05	0.15
L2	0.95	1.05

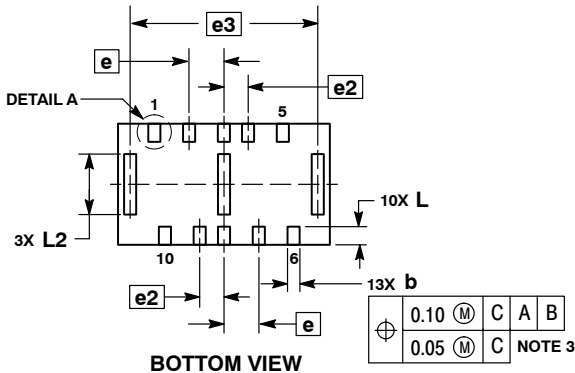
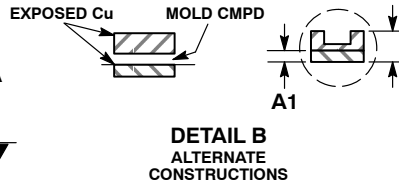
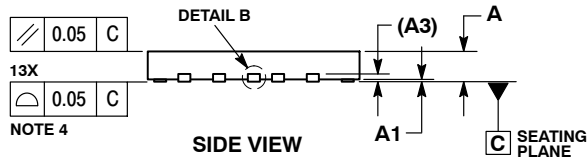

⊕	0.10 (M)	C	A	B
	0.05 (M)	C		

NOTE 3

GENERIC MARKING DIAGRAM*

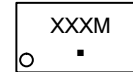

- XXX = Specific Device Code
- M = Date Code
- = Pb-Free Package

*This information is generic. Please refer to device data sheet for actual part marking. Pb-Free indicator, "G" or microdot "▪", may or may not be present.

RECOMMENDED MOUNTING FOOTPRINT

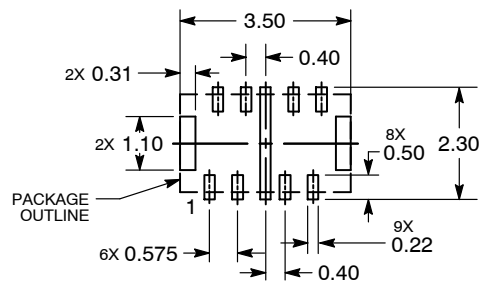

DIMENSIONS: MILLIMETERS

DOCUMENT NUMBER:	98AON79787F	Electronic versions are uncontrolled except when accessed directly from the Document Repository. Printed versions are uncontrolled except when stamped "CONTROLLED COPY" in red.
DESCRIPTION:	UDFN10 3.5X2, 0.575P	PAGE 1 OF 1

ON Semiconductor and ON are trademarks of Semiconductor Components Industries, LLC dba ON Semiconductor or its subsidiaries in the United States and/or other countries. ON Semiconductor reserves the right to make changes without further notice to any products herein. ON Semiconductor makes no warranty, representation or guarantee regarding the suitability of its products for any particular purpose, nor does ON Semiconductor assume any liability arising out of the application or use of any product or circuit, and specifically disclaims any and all liability, including without limitation special, consequential or incidental damages. ON Semiconductor does not convey any license under its patent rights nor the rights of others.

MECHANICAL CASE OUTLINE

PACKAGE DIMENSIONS

ON Semiconductor®

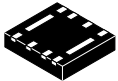

SCALE 4:1

UDFN8 2.2x2, 0.575P CASE 506CV ISSUE A

DATE 21 JUL 2015

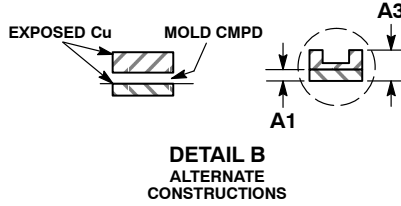
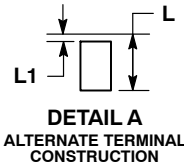
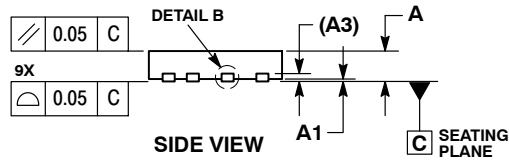
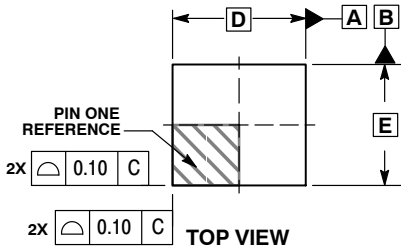

- NOTES:
1. DIMENSIONING AND TOLERANCING PER ASME Y14.5M, 1994.
 2. CONTROLLING DIMENSION: MILLIMETERS.
 3. DIMENSIONS b APPLIES TO PLATED TERMINAL AND IS MEASURED BETWEEN 0.15 AND 0.25 MM FROM TERMINAL TIP.

MILLIMETERS		
DIM	MIN	MAX
A	0.45	0.55
A1	0.00	0.05
A3	0.127	REF
b	0.15	0.25
D	2.20	BSC
E	2.00	BSC
E3	0.20	BSC
e	0.575	BSC
e2	0.40	BSC
L	0.25	0.35
L1	0.05	0.15
L2	0.95	1.05

GENERIC MARKING DIAGRAM*



XX = Specific Device Code
M = Date Code

*This information is generic. Please refer to device data sheet for actual part marking.
Pb-Free indicator, "G" or microdot "▪", may or may not be present.

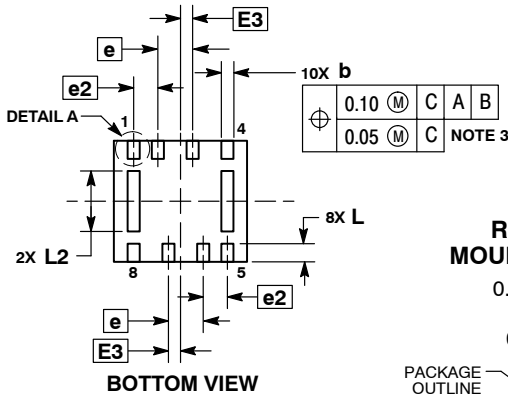

RECOMMENDED MOUNTING FOOTPRINT

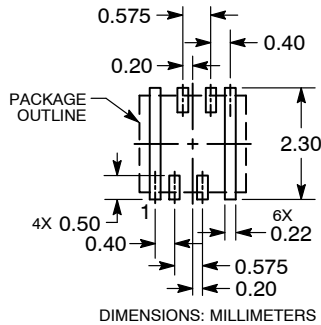

DOCUMENT NUMBER:	98AON79913F	Electronic versions are uncontrolled except when accessed directly from the Document Repository. Printed versions are uncontrolled except when stamped "CONTROLLED COPY" in red.
DESCRIPTION:	UDFN8 2.2X2, 0.575P	PAGE 1 OF 1

ON Semiconductor and ON are trademarks of Semiconductor Components Industries, LLC dba ON Semiconductor or its subsidiaries in the United States and/or other countries. ON Semiconductor reserves the right to make changes without further notice to any products herein. ON Semiconductor makes no warranty, representation or guarantee regarding the suitability of its products for any particular purpose, nor does ON Semiconductor assume any liability arising out of the application or use of any product or circuit, and specifically disclaims any and all liability, including without limitation special, consequential or incidental damages. ON Semiconductor does not convey any license under its patent rights nor the rights of others.

onsemi, **Onsemi**, and other names, marks, and brands are registered and/or common law trademarks of Semiconductor Components Industries, LLC dba "**onsemi**" or its affiliates and/or subsidiaries in the United States and/or other countries. **onsemi** owns the rights to a number of patents, trademarks, copyrights, trade secrets, and other intellectual property. A listing of **onsemi**'s product/patent coverage may be accessed at www.onsemi.com/site/pdf/Patent-Marking.pdf. **onsemi** reserves the right to make changes at any time to any products or information herein, without notice. The information herein is provided "as-is" and **onsemi** makes no warranty, representation or guarantee regarding the accuracy of the information, product features, availability, functionality, or suitability of its products for any particular purpose, nor does **onsemi** assume any liability arising out of the application or use of any product or circuit, and specifically disclaims any and all liability, including without limitation special, consequential or incidental damages. Buyer is responsible for its products and applications using **onsemi** products, including compliance with all laws, regulations and safety requirements or standards, regardless of any support or applications information provided by **onsemi**. "Typical" parameters which may be provided in **onsemi** data sheets and/or specifications can and do vary in different applications and actual performance may vary over time. All operating parameters, including "Typicals" must be validated for each customer application by customer's technical experts. **onsemi** does not convey any license under any of its intellectual property rights nor the rights of others. **onsemi** products are not designed, intended, or authorized for use as a critical component in life support systems or any FDA Class 3 medical devices or medical devices with a same or similar classification in a foreign jurisdiction or any devices intended for implantation in the human body. Should Buyer purchase or use **onsemi** products for any such unintended or unauthorized application, Buyer shall indemnify and hold **onsemi** and its officers, employees, subsidiaries, affiliates, and distributors harmless against all claims, costs, damages, and expenses, and reasonable attorney fees arising out of, directly or indirectly, any claim of personal injury or death associated with such unintended or unauthorized use, even if such claim alleges that **onsemi** was negligent regarding the design or manufacture of the part. **onsemi** is an Equal Opportunity/Affirmative Action Employer. This literature is subject to all applicable copyright laws and is not for resale in any manner.

PUBLICATION ORDERING INFORMATION

LITERATURE FULFILLMENT:

Email Requests to: orderlit@onsemi.com

onsemi Website: www.onsemi.com

TECHNICAL SUPPORT

North American Technical Support:

Voice Mail: 1 800-282-9855 Toll Free USA/Canada

Phone: 011 421 33 790 2910

Europe, Middle East and Africa Technical Support:

Phone: 00421 33 790 2910

For additional information, please contact your local Sales Representative