



EVM54504-BS-00A

5A, 16V, 4-Channel Output, Step-Down Power Module with Internal Auto-Compensation Evaluation Board

DESCRIPTION

The EVM54504-BS-00A is an evaluation board designed to demonstrate the capabilities of the MPM54504, a four-channel output, step-down power module. Each channel can deliver up to 5A of continuous output current across a wide input voltage range (3V to 16V), with excellent load and line regulation. The MPM54504 integrates monolithic power stages and inductors that support passive components to achieve high efficiency.

The MPM54504 features internal auto-compensation, and does not require any external compensation components.

Constant-on-time (COT) control provides fast load transient response, simple loop design, and tight output regulation.

The MPM54504's protection features include short-circuit protection (SCP), over-current protection (OCP), over-voltage protection (OVP), under-voltage protection (UVP), over-temperature protection (OTP), and thermal shutdown (TSD).

The MPM54504 is available in a FCMBGA (9mmx15mmx5mm) package.

ELECTRICAL SPECIFICATIONS

Parameter	Symbol	Value	Units
Input voltage	V_{IN}	12	V
Output voltage (channels 1, 2, 3, and 4)	V_{OUT}	3.3, 2.5, 1.5, 1.2	V
Output current (channels 1, 2, 3, and 4)	I_{OUT}	5, 5, 5, 5	A

FEATURES

- Wide 3V to 16V Operating Input Voltage Range
- 0.6 to 5.5V Output Voltage
- Continuous Output Current (I_{OUT})
 - Four-Channel Output
 - 5A I_{OUT} per Channel
- Constant-On-Time Control (COT) for Fast Transient Response
- Internal Auto-Compensation
- Configurable External Soft-Start (SS) Time
- Enable (EN) and Power Good (PG) for Power Sequencing
- Protection Features: Over-Voltage Protection (OVP), Under-Voltage Protection (UVP), Over-Current Protection (OCP), Short-Circuit Protection (SCP), Over-Temperature Protection (OTP), Thermal Shutdown (TSD)
- Available in a FCMBGA (9mmx15mmx5mm) Package

APPLICATIONS

- Field-Programmable Gate Arrays (FPGAs)
- Digital Signal Processors (DSPs)
- Application-Specific Integrated Circuits (ASICs)
- Multi-Rail Point-of-Load (POL) Power Systems

All MPS parts are lead-free, halogen-free, and adhere to the RoHS directive. For MPS green status, please visit the MPS website under Quality Assurance. "MPS", the MPS logo, and "Simple, Easy Solutions" are registered trademarks of Monolithic Power Systems, Inc. or its subsidiaries.

EVM54504-BS-00A EVALUATION BOARD

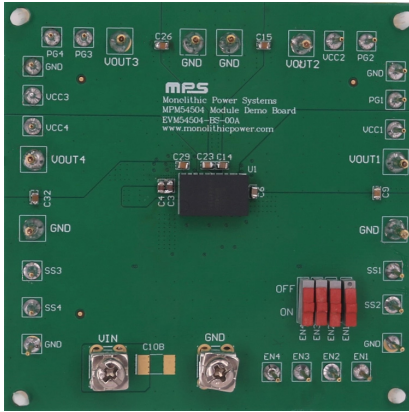

LxWxH (92mmx92mmx1.6mm)

Board Number	MPS IC Number
EVM54504-BS-00A	MPM54504GBS

Efficiency vs. Load Current vs. Power Loss

$V_{IN} = 12V$

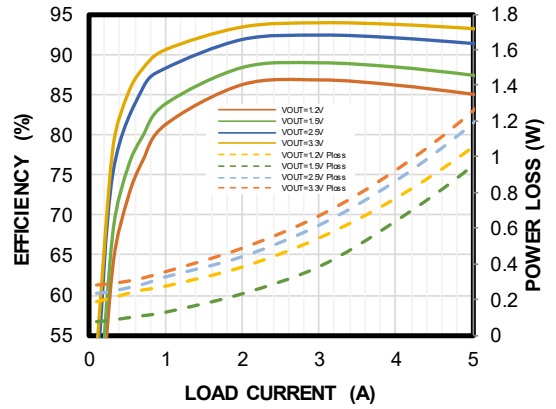

QUICK START GUIDE

1. Preset the power supply between 3V and 16V, then turn off the power supply.
2. Connect the power supply terminals to:
 - a. Positive (+): VIN
 - b. Negative (-): GND
3. Connect the load terminals ($\leq 5A$) of channels 1, 2, 3, and 4 to:
 - a. Positive (+): VOUT
 - b. Negative (-): GND
4. After making the connections, turn on the power supply. The board should automatically start up.

EVALUATION BOARD SCHEMATIC

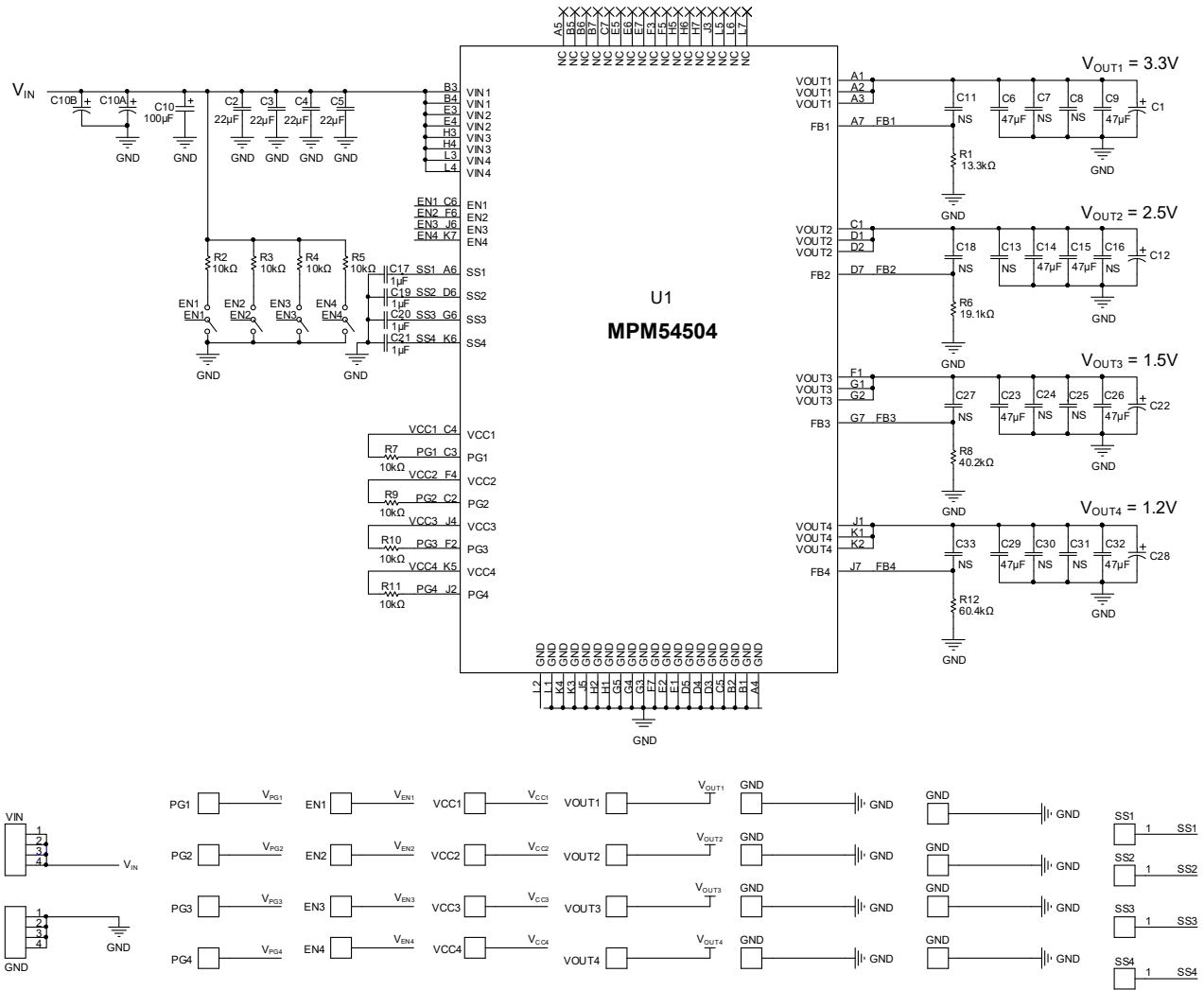

Figure 1: Evaluation Board Schematic

EVM54504-BS-00A BILL OF MATERIALS

Qty	Ref	Value	Description	Package	Manufacturer	Manufacturer P/N
1	C10	100 μ F	Electrolytic capacitor, 35V	SMD	Chemicon	EMZJ350ADA101MF80G
4	C2, C3, C4, C5	22 μ F	Ceramic capacitor, 25V, X5R	0805	Murata	GRM21BR61E226ME44L
4	C17, C19, C20, C21	1 μ F	Ceramic capacitor, 16V, X5R	0603	Murata	GRM185R61C105KE44D
8	C6, C9, C15, C14, C23, C26, C29, C32	47 μ F	Ceramic capacitor, 10V, X5R	0805	Murata	GRM21BR61A476ME15L
1	R1	13k Ω	Film resistor, 1%	0603	Yageo	CRCW040213K3FKED
1	R6	19k Ω	Film resistor, 1%	0603	Yageo	RC0603FR-0719K1L
1	R8	40.2k Ω	Film resistor, 1%	0603	Yageo	RC0603FR-0740K2L
1	R12	60k Ω	Film resistor, 1%	0603	Yageo	RC0603FR-0760K4L
8	R2, R3, R4, R5, R7, R9, R10, R11	10k Ω	Film resistor, 1%	0603	Yageo	RC0603FR0710K2L
1	U1	MPM54504	Power module	FCMBGA (9mmx15mm x5mm)	MPS	MPM54504GBS

EVB TEST RESULTS

Performance curves and waveforms are tested on the evaluation board. $V_{IN} = 12V$, $V_{OUT1} = 3.3V$, $V_{OUT2} = 2.5V$, $V_{OUT3} = 1.5V$, $V_{OUT4} = 1.2V$, $T_A = 25^\circ C$, unless otherwise noted.

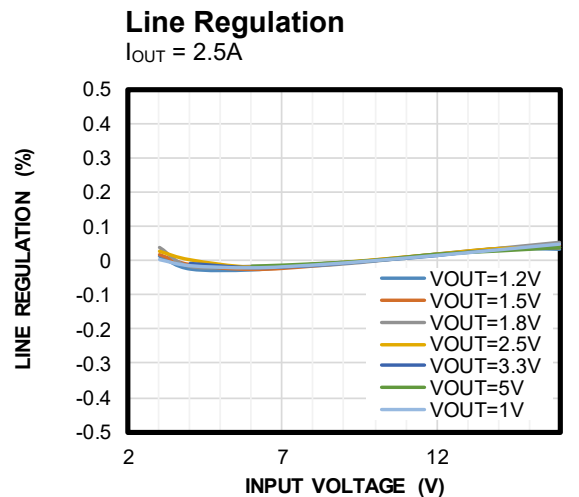
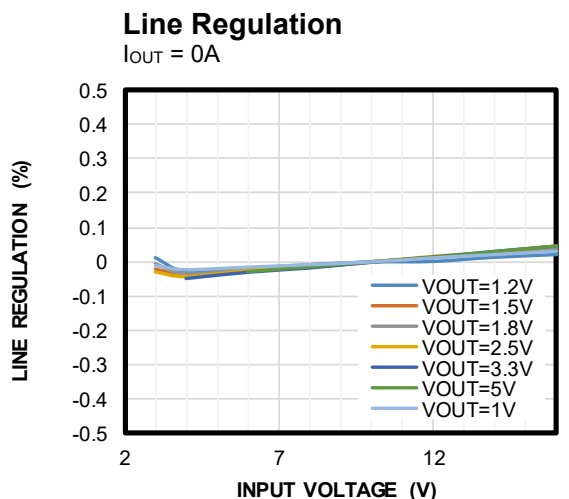
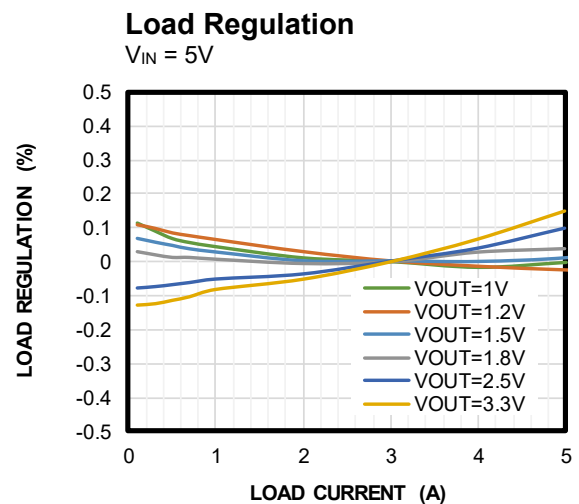
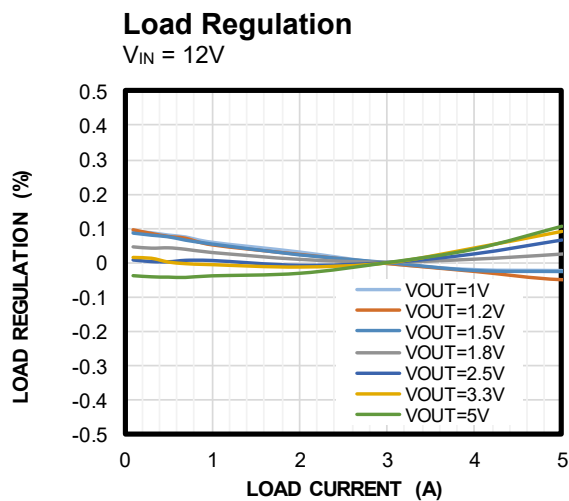
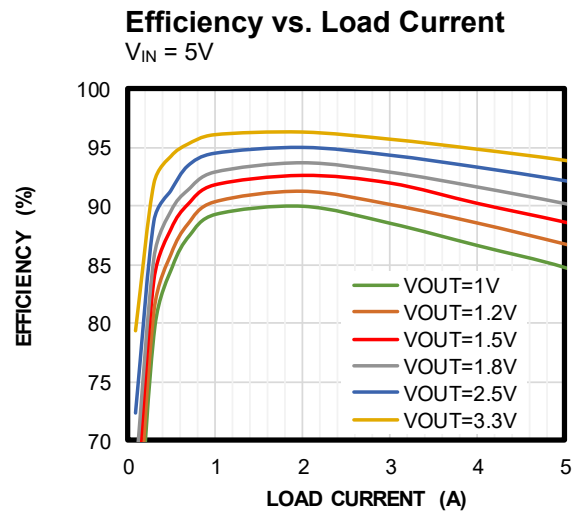
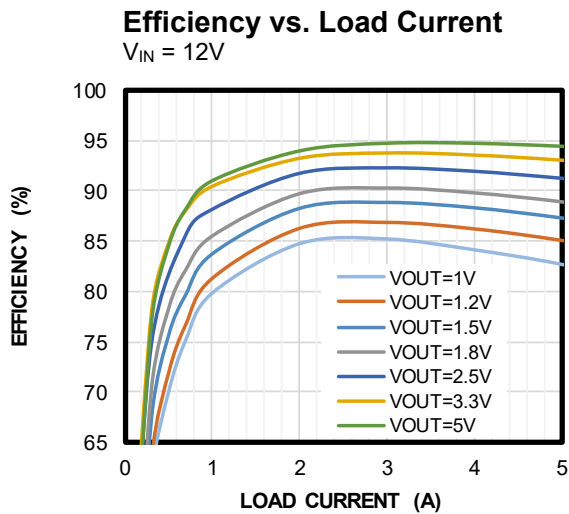

EVB TEST RESULTS (continued)

Performance curves and waveforms are tested on the evaluation board. $V_{IN} = 12V$, $V_{OUT1} = 3.3V$, $V_{OUT2} = 2.5V$, $V_{OUT3} = 1.5V$, $V_{OUT4} = 1.2V$, $T_A = 25^{\circ}C$, unless otherwise noted.

Start-Up through VIN

$V_{OUT} = 1.5V$, $I_{OUT} = 5A$

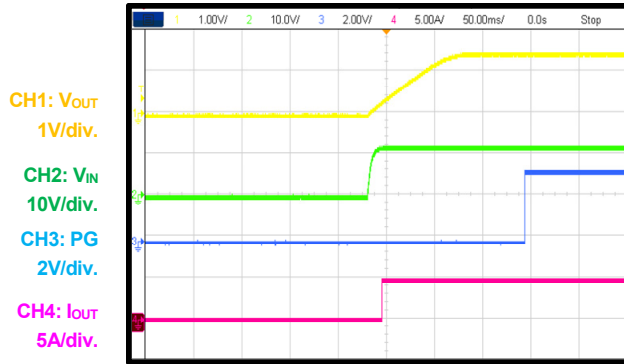

50ms/div.

Shutdown through VIN

$V_{OUT} = 1.5V$, $I_{OUT} = 5A$

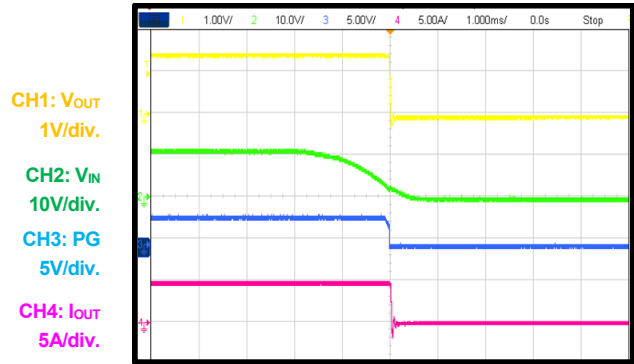

1ms/div.

Start-Up through EN

$V_{OUT} = 1.5V$, $I_{OUT} = 5A$

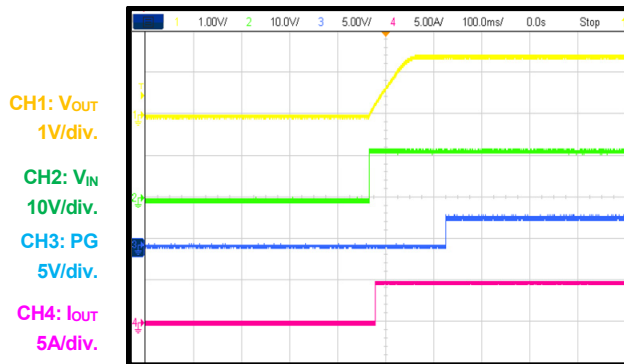

100ms/div.

Shutdown through EN

$V_{OUT} = 1.5V$, $I_{OUT} = 5A$

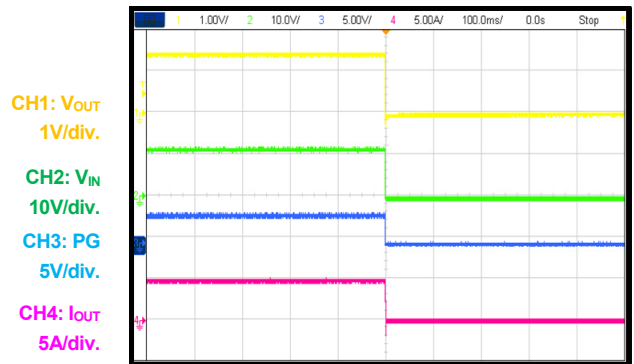

100ms/div.

SCP Entry and Recovery

$V_{OUT} = 1.5V$

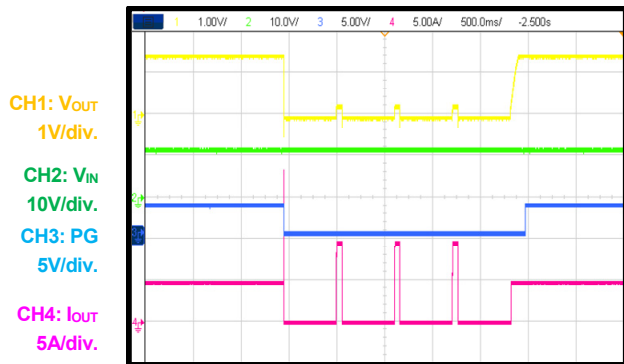

500ms/div.

Pre-Biased Load

$V_{OUT} = 1.5V$, $V_{PR} = 1V$

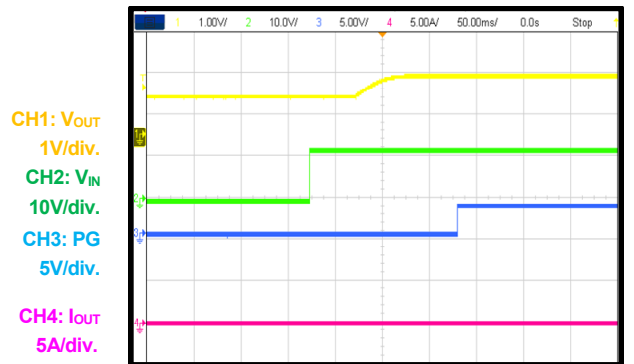

50ms/div.

EVB TEST RESULTS (continued)

Performance curves and waveforms are tested on the evaluation board. $V_{IN} = 12V$, $V_{OUT1} = 3.3V$, $V_{OUT2} = 2.5V$, $V_{OUT3} = 1.5V$, $V_{OUT4} = 1.2V$, $T_A = 25^\circ C$, unless otherwise noted.

V_{OUT} Ripple

$V_{OUT} = 1.5V$, $I_{OUT} = 5A$

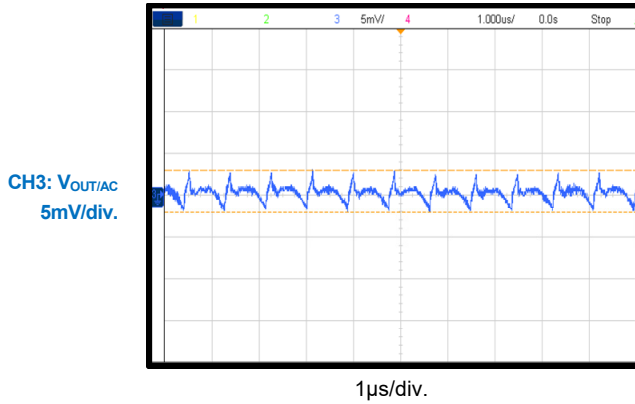

Load Transient

$V_{OUT} = 1V$, $C_{FF} = 100pF$, $C_{OUT} = 47µF$,
1A/µs slew rate

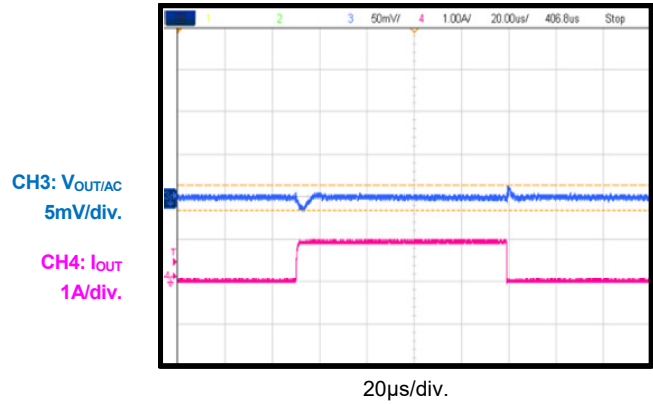

Load Transient

$V_{OUT} = 1V$, $C_{FF} = 100pF$, $C_{OUT} = 47µF$,
1A/µs slew rate

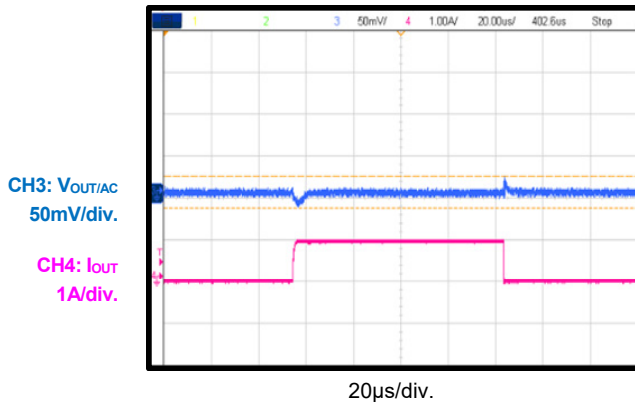

Load Transient

$V_{OUT} = 2.5V$, $C_{FF} = 100pF$, $C_{OUT} = 47µF$,
1A/µs slew rate

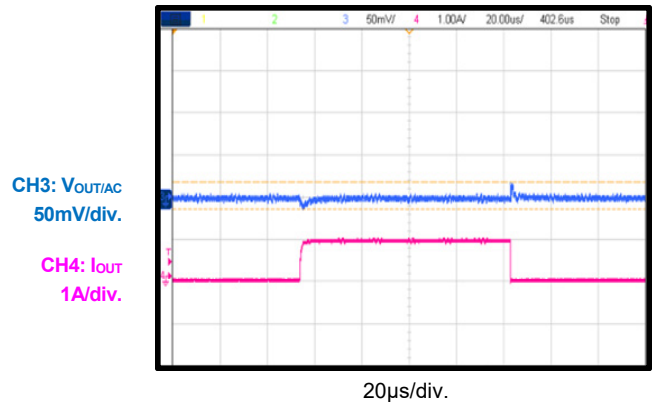

PCB LAYOUT

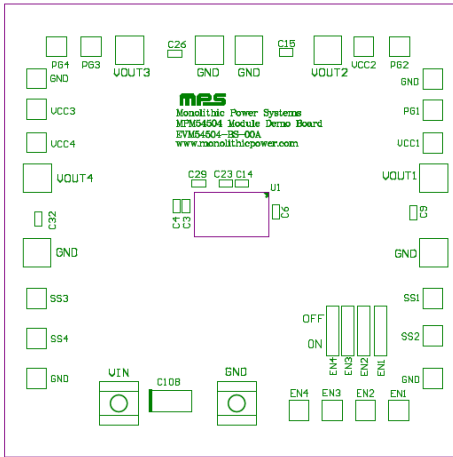

Figure 2: Top Silk

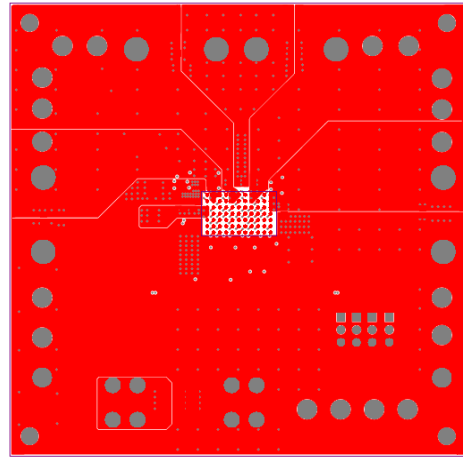

Figure 3: Top Layer

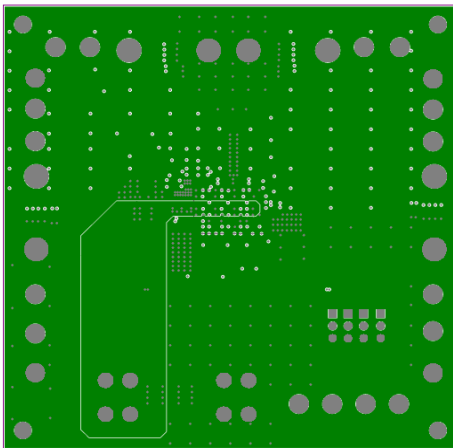

Figure 4: Mid-Layer 1

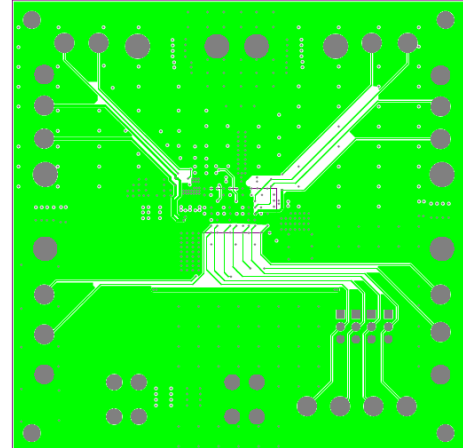

Figure 5: Mid-Layer 2

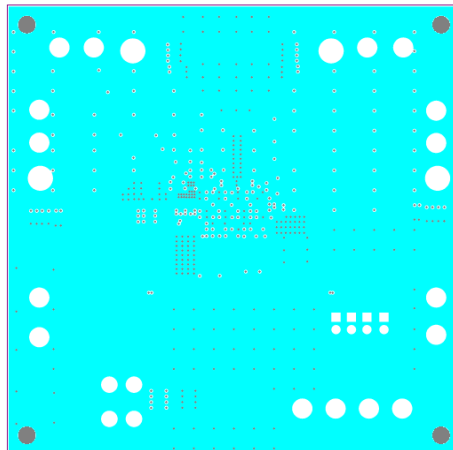

Figure 6: Mid-Layer 3

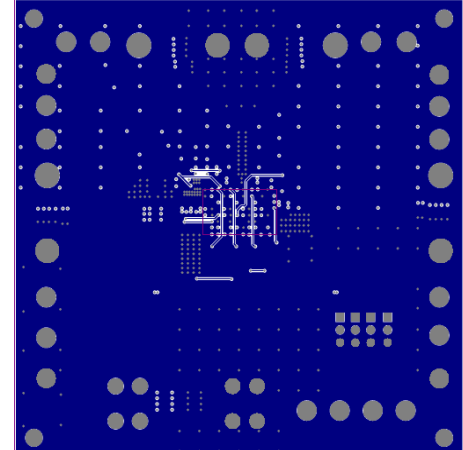

Figure 7: Mid-Layer 4

PCB LAYOUT (continued)

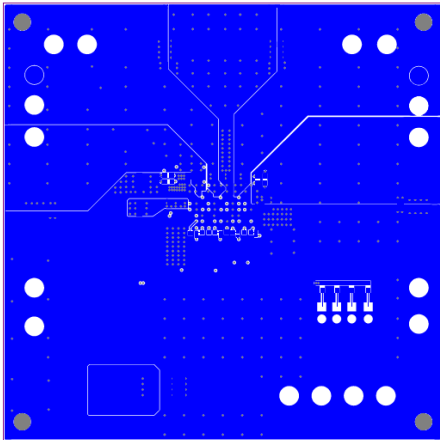

Figure 8: Bottom Layer

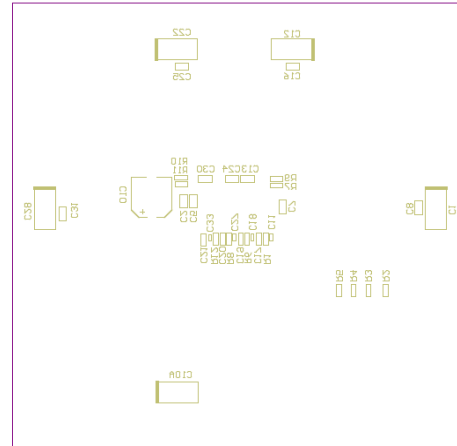

Figure 9: Bottom Silk



REVISION HISTORY

Revision #	Revision Date	Description	Pages Updated
1.0	4/28/2021	Initial Release	-

Notice: The information in this document is subject to change without notice. Please contact MPS for current specifications. Users should warrant and guarantee that third-party Intellectual Property rights are not infringed upon when integrating MPS products into any application. MPS will not assume any legal responsibility for any said applications.