

556 SERIES



Rack And Panel Connectors

Features:

- 0.156" (3.96mm) contact spacing
- Available in plug and receptacle.
- Edacon hermaphroditic contact mating design
- Contact termination options include crimp, P.C. tail, wire hole, wire wrap and taper tail
- Tools available for contact installation, removal and crimping
- RoHS Compliant

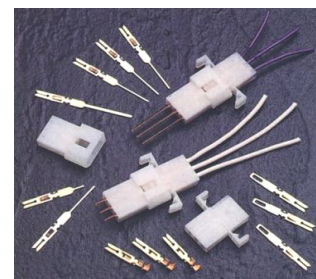

Specifications:

Insulator Material	Nylon UL 94V-0 , White Color
Contact Material	Copper Alloy
Contact Plating	Gold Plating over Nickel over entire contact
Current Rating	8.5 amps
Contact Resistance	10 milliohms maximum
Dielectric Withstanding Voltage	2000 V AC rms at sea level
Insulation Resistance	5000 megaohms minimum
Operating Temperature	-40°C to +105°C
Insertion	2 to 16 oz (0.56 to 4.45N) per contact position
Withdrawal Force	2 to 16 oz (0.56 to 4.45N) per contact position

Example Part Number: **556-003-500-102**

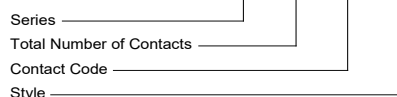

Series:

556

Total Number of Contacts:

003

Contact Code:	Description:	Tail Size:	Tail Length "G":
000	No Contacts Assembled	-----	-----
500	Wire Hole	.110 x .024 (2.79 x 0.61)	.245 (6.22)
501	Taper Tail	.110 x .024 (2.79 x 0.61)	.245 (6.22)
520	P.C. Tail	.025 x .024 (0.64 x 0.61)	.215 (5.46)
540	Wire Wrap	.050 x .024 (1.27 x 0.61)	.600 (15.24)
541	Wire Wrap	.026 x .024 (0.66 x 0.61)	.620 (15.70)
542	Wire Wrap	.050 x .024 (1.27 x 0.61)	.790 (20.07)

Style & Material:

Style:	Description:
101	Receptacle
102	Receptacle with Panel Retention
201	Plug

Ordering Code Notes:

- Crimp contacts are also available for 556 series connectors. Contacts may be ordered separately for pre-wired or select position assembly.

Part Number	Description	Silhouette
516-290-500	Wire Hole	
516-290-501	Taper Tail	
516-290-520	P.C. Tail	
516-290-540	Wire Wrap	
516-290-541	Wire Wrap	
516-290-542	Wire Wrap	
516-290-590	Crimp (Loose)	
516-294-571	Crimp - 1800 Contact Per Reel	

- For contact installation, removal and crimping tools, Please contact EDAC.
- Insulator design prevents improper mating of individual plug and receptacle

FEMALE CONNECTOR
(Hermaphroditic contacts)

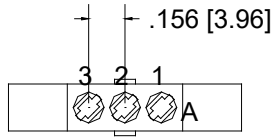

MALE CONNECTOR
(Hermaphroditic contacts)

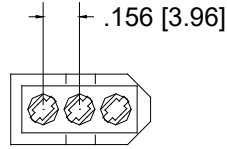

RECOMMENDED
PANEL OPENING
(If Desired)

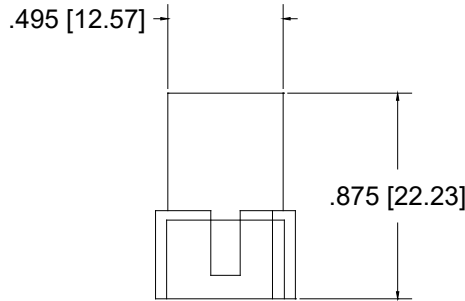
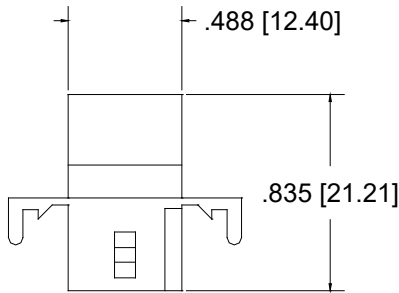
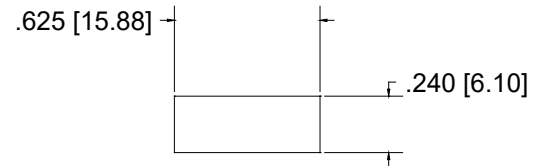

RECOMMENDED
BOARD LAYOUT

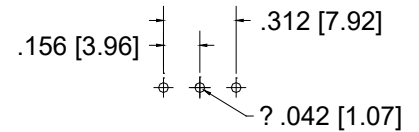

CONNECTOR MATING FACE VIEWS

