

Side Face Silicon Phototransistor PT5529B/L2-F

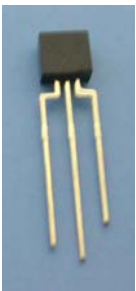

Features

- Fast response time
- High photo sensitivity
- Pb free
- This product itself will remain within RoHS compliant version.

Description

- PT5529B/L2-F is a high speed and high sensitive dual phototransistor molded in a black plastic package with flat side view.
- The device is spectrally matched with IR emitters.

Applications

- Mouse
- Optoelectronic Switch
- Photo Interrupter

Device Selection Guide

Chip Materials	Lens Color
Si	Black

Absolute Maximum Ratings (Ta=25°C)

Parameter	Symbol	Rating	Unit
Collector-Emitter Voltage	V_{CEO}	30	V
Emitter-Collector-Voltage	V_{ECO}	5	V
Collector Current	I_C	20	mA
Operating Temperature	T_{opr}	-25 ~ +85°C	°C
Storage Temperature	T_{stg}	-40 ~ +85°C	°C
Lead Soldering Temperature(*1)	T_{sol}	260	°C
Power Dissipation at (or below) 25°C Free Air Temperature	P_D	75	mW

Notes: *1:Soldering time \leq 5 seconds.

Electro-Optical Characteristics (Ta=25°C)

Parameter	Symbol	Condition	Min	Typ	Max	Unit
Collector – Emitter Breakdown Voltage	BV_{CEO}	$I_C=100\mu A$ $E_e=0mW/cm^2$	30	---	---	V
Emitter-Collector Breakdown Voltage	BV_{ECO}	$I_E=100\mu A$ $E_e=0mW/cm^2$	5	---	---	V
Collector-Emitter Saturation Voltage	$V_{CE(sat)}$	$I_C=2mA$ $E_e=1mW/cm^2$	---	---	0.4	V
Rise Time	t_r	$V_{CE}=5V$ $I_C=1mA$ $R_L=1000\Omega$	---	15	---	μS
Fall Time	t_f		---	15	---	
Collector Dark Current	I_{CEO}	$E_e=0mW/cm^2$ $V_{CE}=20V$	---	---	100	nA
On State Collector Current	$I_{C(on)}$	$V_{CE}=5V,$ $E_e=0.555mW/cm^2$	129	---	1085	μA
Wavelength of Peak Sensitivity	λ_p	---	---	940	---	nm
Rang of Spectral Bandwidth	$\lambda_{0.5}$	---	760	---	1100	nm

Test Method For On State Collector Current :

Condition : $E_e=0.555\text{mW/cm}^2$, $V_{CE}=5\text{V}$

Test Item : Collector Current [$I_{C(ON)}$]

Unit : μA

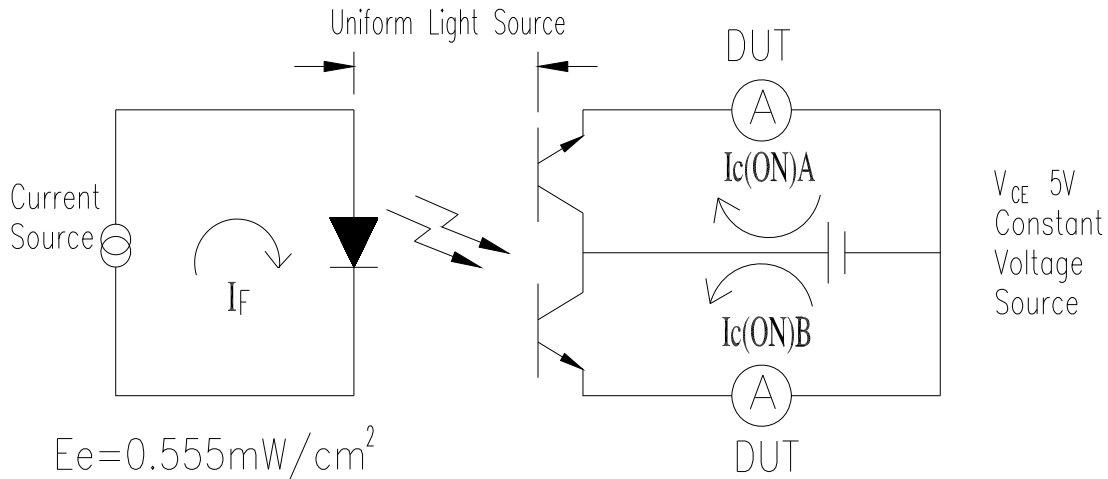

To Distinguish Intensity:

Condition: $V_{CE}=5\text{V}$ $E_e=0.555\text{mW/cm}^2$

Ranks

Ranks	Symbol	Min	Typ	Max	Unit	Test Condition
A1	$I_{C(ON)}$	129	---	226	μA	$E_e=0.555\text{mW/c m}^2$ $V_{CE}=5\text{V}$
A2	$I_{C(ON)}$	195	---	306	μA	$E_e=0.555\text{mW/c m}^2$ $V_{CE}=5\text{V}$
A3	$I_{C(ON)}$	262	---	380	μA	$E_e=0.555\text{mW/c m}^2$ $V_{CE}=5\text{V}$
A4	$I_{C(ON)}$	330	---	461	μA	$E_e=0.555\text{mW/c m}^2$ $V_{CE}=5\text{V}$
A5	$I_{C(ON)}$	398	---	544	μA	$E_e=0.555\text{mW/c m}^2$ $V_{CE}=5\text{V}$
A6	$I_{C(ON)}$	468	---	625	μA	$E_e=0.555\text{mW/c m}^2$ $V_{CE}=5\text{V}$
A7	$I_{C(ON)}$	536	---	703	μA	$E_e=0.555\text{mW/c m}^2$ $V_{CE}=5\text{V}$
A8	$I_{C(ON)}$	604	---	785	μA	$E_e=0.555\text{mW/c m}^2$ $V_{CE}=5\text{V}$
A9	$I_{C(ON)}$	673	---	862	μA	$E_e=0.555\text{mW/c m}^2$ $V_{CE}=5\text{V}$
A10	$I_{C(ON)}$	742	---	944	μA	$E_e=0.555\text{mW/c m}^2$ $V_{CE}=5\text{V}$
A11	$I_{C(ON)}$	812	---	1018	μA	$E_e=0.555\text{mW/c m}^2$ $V_{CE}=5\text{V}$
A12	$I_{C(ON)}$	882	---	1085	μA	$E_e=0.555\text{mW/c m}^2$ $V_{CE}=5\text{V}$

Typical Electro-Optical Characteristics Curves

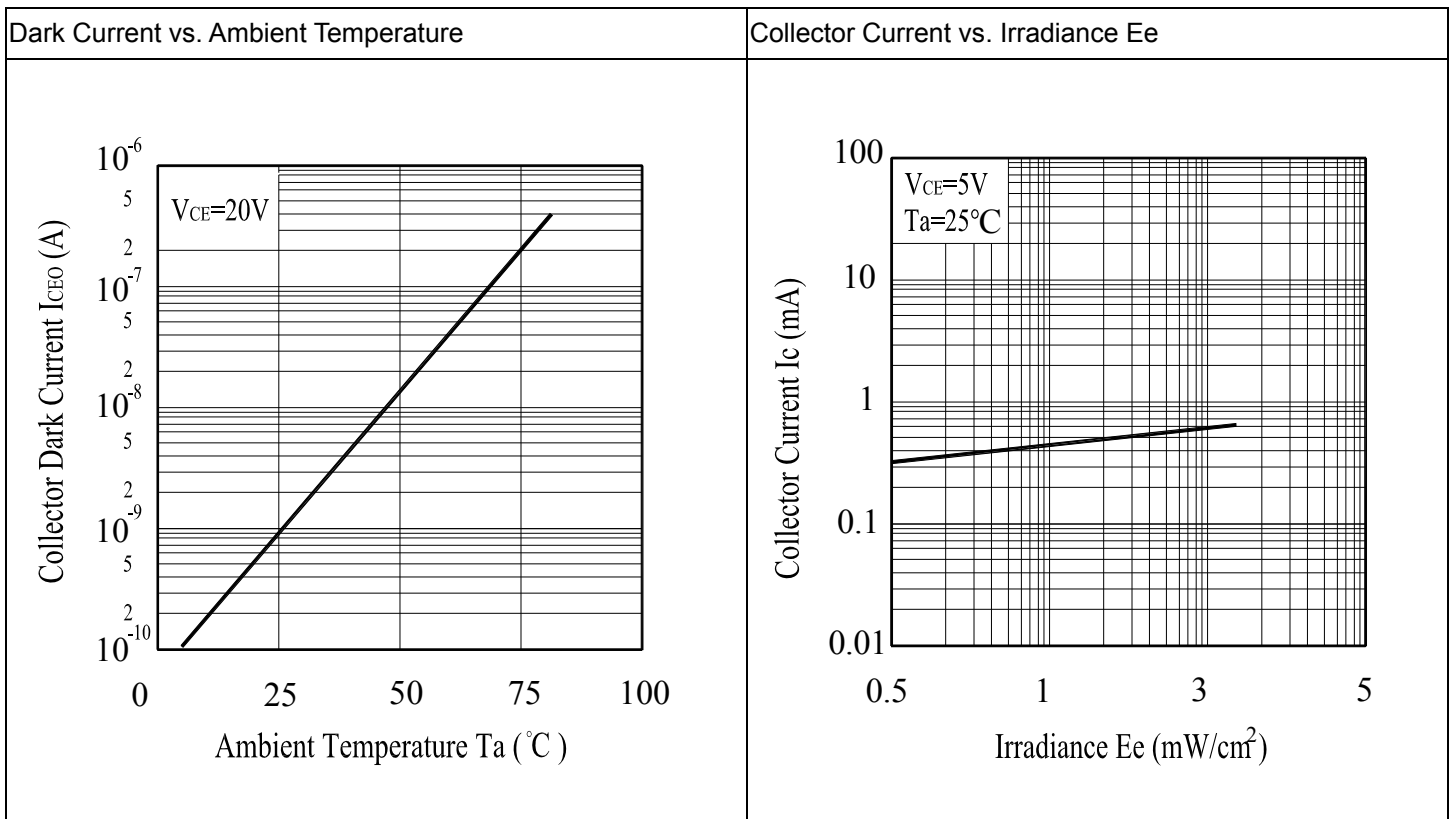
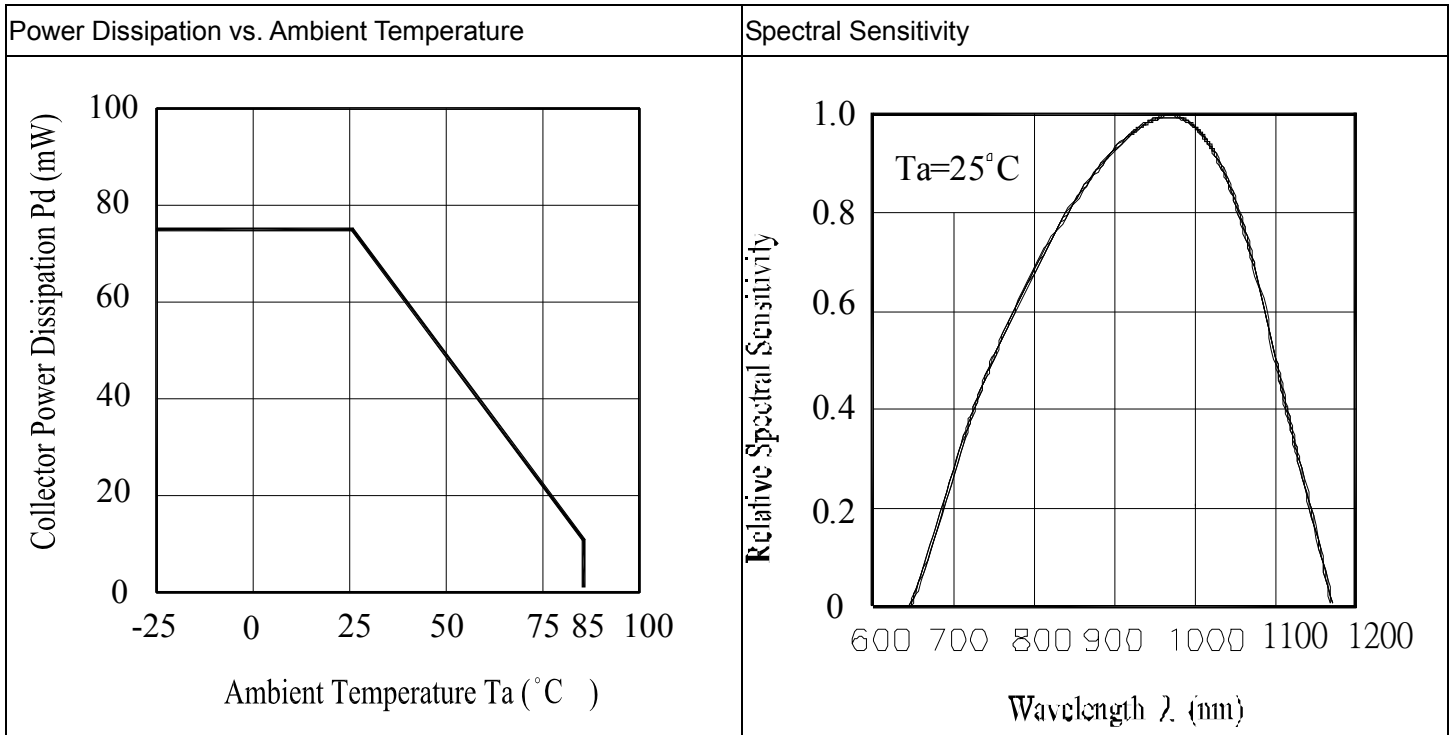

Package Dimension

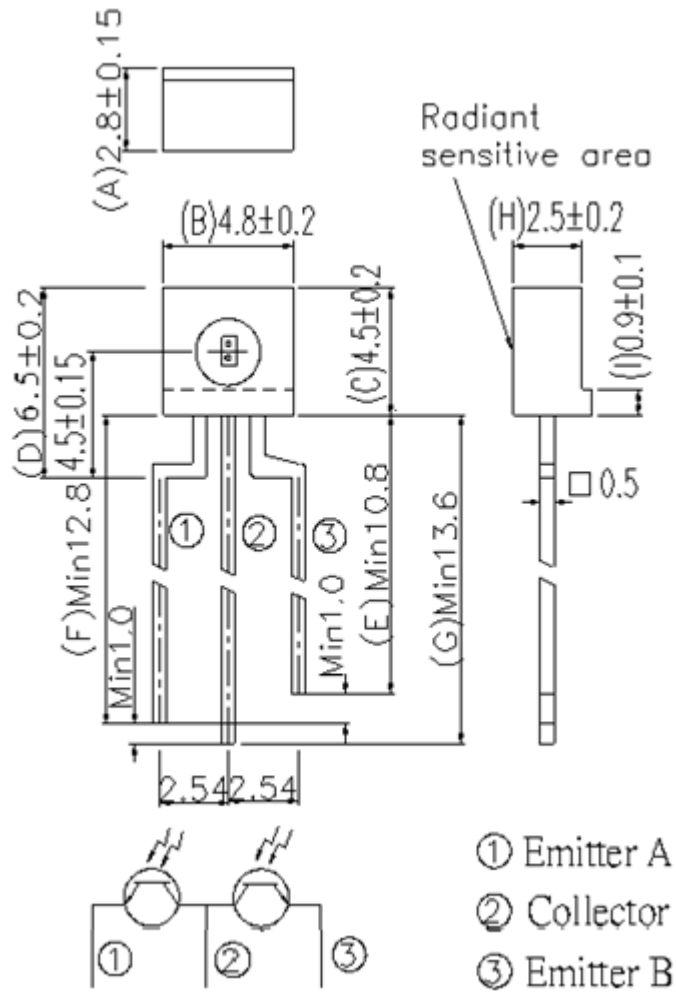

Note: Tolerances unless dimensions $\pm 0.25\text{mm}$

Packing Quantity Specification

1. 1000PCS/1Bag,6Bag/1Box
2. 10Boxes/1Carton

Label Form Specification

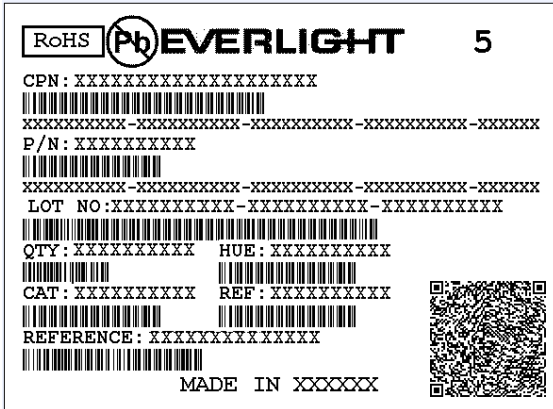

- CPN: Customer's Product Number
- P/N: Product Number
- QTY: Packing Quantity
- CAT: Luminous Intensity Rank
- HUE: Dom. Wavelength Rank
- REF: Forward Voltage Rank
- LOT No: Lot Number
- Reference: Identify Label Number

Packing Specification

■ PE bag

■ Inner Carton

■ Outside Carton

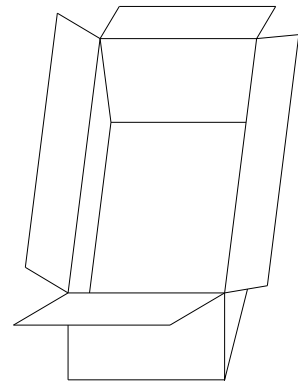
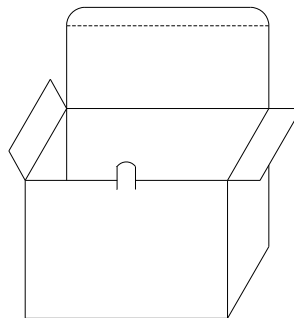
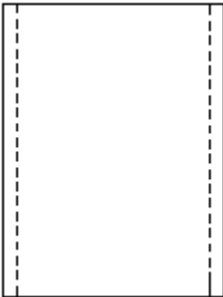

Notes

1. Above specification may be changed without notice. EVERLIGHT will reserve authority on material change for above specification.
2. When using this product, please observe the absolute maximum ratings and the instruction for using outlined in these specification sheets. EVERLIGHT assumes no responsibility for any damage resulting from use of the product which does not comply with the absolute maximum ratings and the instructions included in these specification sheets.
3. These specification sheets include materials protected under copyright of EVERLIGHT corporation. Please don't reproduce or cause anyone to reproduce them without EVERLIGHT's consent.