

THIS DOCUMENT IS THE PROPERTY OF
KEYSTONE ELECTRONICS CORP. AND
SHALL NOT BE REPRODUCED, DISTRIBUTED
OR USED AS A BASIS FOR MANUFACTURE
WITHOUT PRIOR WRITTEN PERMISSION
FROM KEYSTONE ELECTRONICS CORP.

ACTUAL SIZE

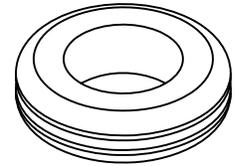
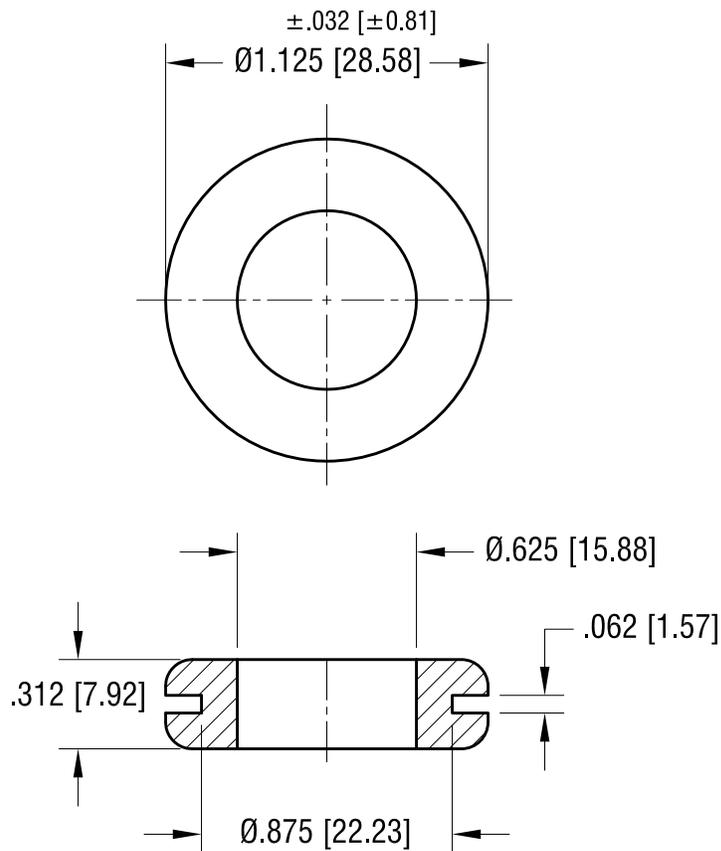

10.13.21	CHANGE AS PER ECN 21-118	B
1.02.08	CHANGE AS PER ECN 08-008	A
DATE	DESCRIPTION	REV.

KEYSTONE ELECTRONICS CORP.			
www.keyelco.com • NEW HYDE PARK NY 11040 • Tel (516)328-7500			
PART NAME		RUBBER GROMMET	
MATERIAL		BUNA 'N'	
FINISH	NONE	DRN BY	BOONE
		DATE	9.16.96
		APP'D	RH
		SCALE	1.5X
TOLERANCES	INCH [MM]	CODE	DWG NO.
DECIMAL	$\pm .020$ [± 0.50]	C	752
ANGULAR	$\pm 1^\circ$		
UNLESS OTHERWISE SPECIFIED			